

# INSTRUCTION

# MANUAL

# 使用说明书

# TETA INVERTER

**200V Class**

**0.75 ~ 55 kw**

**1 ~ 75 HP**

**380V Class**

**0.75 ~ 185 kw**

**1 ~ 250 HP**



**TETA** INVERTER

# MA510 Series

# Table of Contents

Preface.	1
Chapter 1 Safety Precautions	2
1.1 Before Supplying Power to the Inverter	2
1.2 Wiring	3
1.3 Before Operation	4
1.4 Parameters Setting	4
1.5 Operation	5
1.6 Maintenance, Inspection and Replacement	6
1.7 Disposal of the Inverter	6
Chapter 2 Model Description	7
2.1 Nameplate Data.	7
2.2 Inverter Models-Motor Power Rating	8
Chapter 3 Environment and Installation	9
3.1 Environment	9
3.2 Installation	10
3.2.1 Installation Spaces	10
3.2.2 External View and part description	11
3.2.3 Unpacking inspection	13
3.2.4 Disassemble and installation	13
3.3 Inverter Wiring	15
3.3.1 Wiring Peripheral Power Devices	15
3.3.2 General Wiring Diagram	16
3.3.3 Terminal description	17
3.3.4 Wiring Precautions	22
Chapter 4 Keypad and Programming Functions	25
4.4.1 Keypad Operation Description	27
4.4.1.1 Parameter setting	27
Chapter 5 Overall Dimension drawing	29
Chapter 6 Braking resistor	33
Chapter 7 Parameter list	35
Chapter 8 Trouble shooting	36

## Preface

The MA510 product is an inverter designed to control a three-phase induction motor. Please read this manual carefully to ensure correct operation, safety and to become familiar with the inverter functions.

The MA510 inverter is an electrical / electronic product and must be installed and handled by qualified service personnel.

Improper handling may result in incorrect operation, shorter life cycle, or failure of this product as well as the motor.

All MA510 documentation is subject to change without notice. Be sure to obtain the latest editions for use or visit our website at [www.tetaelectric.com](http://www.tetaelectric.com)



Available Documentation:



1. MA510 Start-up and Installation Manual
2. MA10 Instruction Manual

Read this instruction manual thoroughly before proceeding with installation, connections(wiring), operation, or maintenance and inspection.

Ensure you have sound knowledge of the inverter and familiarize yourself with all safety information and precautions before proceeding to operate the inverter.

Please pay close attention to the safety precautions indicated by the

warning  and caution  symbol.

 <b>Warning</b>	Failure to ignore the information indicated by the warning symbol may result in death or serious injury.
 <b>Caution</b>	Failure to ignore the information indicated by the caution symbol may result in minor or moderate injury and/or substantial property damage.

## Chapter 1 Safety Precautions

### 1.1 Before Supplying Power to the Inverter



#### Warning

The main circuit must be correctly wired. For single phase supply use input terminals (R/L1, T/L3) and for three phase supply use input terminals (R/L1, S/L2, T/L3). Terminals U/T1, V/T2, W/T3 must only be used to connect the motor. Connecting the input supply to any of the U/T1, V/T2 or W/T3 terminals will cause damage to the inverter.



#### Caution

To avoid the front cover from disengaging or other physical damage, do not carry the inverter by its cover. Support the unit by its heat sink when transporting. Improper handling can damage the inverter or injure personnel, and should be avoided.

- To avoid the risk of fire, do not install the inverter on or near flammable objects. Install on nonflammable objects such as metal surfaces.
- If several inverters are placed inside the same control panel, provide adequate ventilation to maintain the temperature below 40°C/104°F (50°C/122°F without a dust cover) to avoid overheating or fire.
- When removing or installing the digital operator, turn off the power first, and then follow the instructions in this manual to avoid operator error or loss of display caused by faulty connections.



#### Warning

- This product is sold subject to IEC 61800-3. In a domestic environment this product may cause radio interference in which case the user may need to apply corrective measures
- Over temperature protection function on motor is disabled.

## 1.2 Wiring



### Warning

- Always turn OFF the power supply before attempting inverter installation and wiring of the user terminals.
- Wiring must be performed by a qualified personnel / certified electrician.
- Make sure the inverter is properly grounded. (200V Class: Grounding impedance shall be less than 100Ω. 400V Class: Grounding impedance shall be less than 10Ω.) It is required to disconnect the ground wire in the control board to avoid the sudden surge causing damage on electronic parts if it is improperly grounded.
- Please check and test emergency stop circuits after wiring. (Installer is responsible for the correct wiring.)
- Never touch any of the input or output power lines directly or allow any input or output power lines to come in contact with the inverter case.
- Do not perform a dielectric voltage withstand test (megger) on the inverter or this will result in inverter damage to the semiconductor components.



### Caution

- The line voltage applied must comply with the inverter's specified input voltage.
- Connect braking resistor and braking unit to the designated terminals.
- Do not connect a braking resistor directly to the DC terminals P(+) and N(-), otherwise fire may result.
- Use wire gauge recommendations and torque specifications.
- Never connect input power to the inverter output terminals U/T1, V/T2, W/T3.
- Do not connect a contactor or switch in series with the inverter and the motor.
- Do not connect a power factor correction capacitor or surge suppressor to the inverter output.
- Ensure the interference generated by the inverter and motor does not affect peripheral devices.

### 1.3 Before Operation



#### Warning

- Reduce the carrier frequency (parameter P0-14) if the cable from the inverter to the motor is over 80 ft (25m). A high-frequency current can be generated by stray capacitance between the cables and result in an overcurrent trip of the inverter, an increase in leakage current, or an inaccurate current readout.
- Be sure to install all covers before turning on power. Do not remove any of the covers while power to the inverter is on, otherwise electric shock may occur.
- Do not operate switches with wet hands, otherwise electric shock may result.
- Do not touch inverter terminals when energized even if inverter has stopped, otherwise electric shock may result.

### 1.4 Parameter Setting



#### Caution

- Do not connect a load to the motor while performing an auto-tune.
- Make sure the motor can freely run and there is sufficient space around the motor when performing a rotational auto-tune.

## 1.5 Operation



### Warning

- Do not connect or disconnect the motor during operation. This will cause the inverter to trip and may cause damage to the inverter.
- Operations may start suddenly if an alarm or fault is reset with a run command active. Confirm that no run command is active upon resetting the alarm or fault, otherwise accidents may occur.
- If automatic restart after power recovery (parameter P1-14) is enabled, the inverter will start automatically after power is restored.
- Make sure it is safe to operate the inverter and motor before performing a rotational auto-tune.
- Do not check signals on circuit boards while the inverter is running.
- After the power is turned off, the cooling fan may continue to run for some time.



### Caution

- Do not touch heat-generating components such as heat sinks and braking resistors.
- Carefully check the performance of motor or machine before operating at high speed, otherwise Injury may result.
- Note the parameter settings related to the braking unit when applicable.
- Do not use the inverter braking function for mechanical holding, otherwise injury may result.
- Do not check signals on circuit boards while the inverter is running.

## 1.6 Maintenance, Inspection and Replacement



### Warning

- Wait a minimum of 5 minutes after power has been turned OFF before starting an inspection. Also confirm that the charge light is OFF and that the DC bus voltage has dropped below 25Vdc. Wait a minimum of 15 minutes while inverter is over 20HP.
- Never touch high voltage terminals in the inverter.
- Make sure power to the inverter is disconnected before disassembling the inverter.
- Only authorized personnel should perform maintenance, inspection, and replacement operations. (Take off metal jewelry such as watches and rings and use insulated tools.)



### Caution

- The Inverter can be used in an environment with a temperature range from 14° - 104°F (-10 ~ 40°C) and relative humidity of 95% non-condensing.
- The inverter must be operated in a dust, gas, mist and moisture free environment.

## 1.7 Disposal of the Inverter



### Caution

- Please dispose of this unit with care as an industrial waste and according to your required local regulations.
- The capacitors of inverter main circuit and printed circuit board are considered as hazardous waste and must not be burned.
- The Plastic enclosure and parts of the inverter such as the top cover board will release harmful gases if burned.



## Chapter 2 Model Description

### 2.1 Nameplate Data

It is essential to verify the MA510 inverter nameplate and make sure that the MA510 inverter has the correct rating so it can be used in your application with the proper sized AC motor.

#### Unpack the MA510 inverter and check the following:

- (1) The MA510 inverter and quick setting guide are contained in the package.
- (2) The MA510 inverter has not been damaged during transportation there should be no dents or parts missing.
- (3) The MA510 inverter is the type you ordered. You can check the type and specifications on the main nameplate.
- (4) Check that the input voltage range meets the input power requirements.
- (5) Ensure that the motor HP matches the motor rating of the inverter.

#### Model Identification

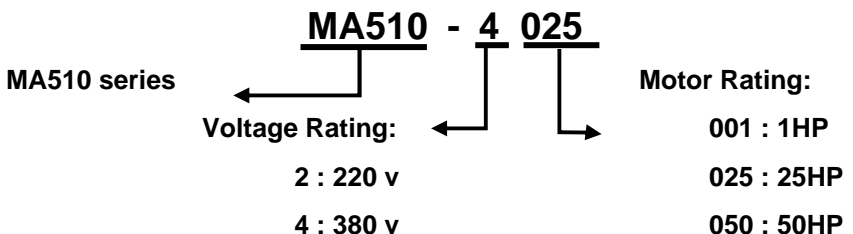
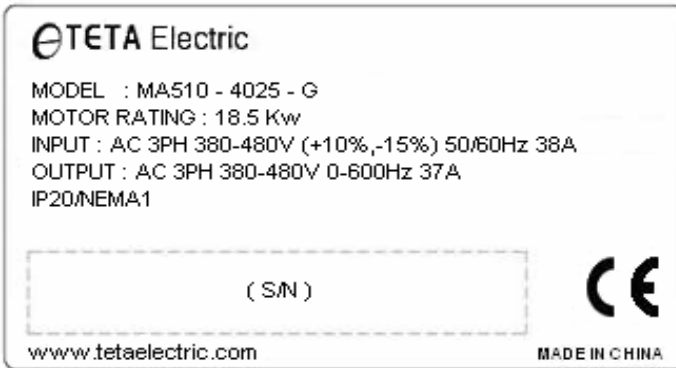

## 2.2 Inverter Models-Motor Power Rating

Model Number	Input Voltage	Rated Power (kw)	Rated input current (A)	Rated output current (A)	Compatible Motor (HP)
MA510-2001	3-phase 220V -+ 15%	0.75	5	4.5	1
MA510-2002		1.5	7.7	7	2
MA510-2003		2.2	11	10	3
MA510-2005		4	17	16	5
MA510-2008		5.5	21	20	7.5
MA510-2010		7.5	31	30	10
MA510-2015		11	43	42	15
MA510-2020		15	56	55	20
MA510-2025		18.5	71	70	25
MA510-2030		22	81	80	30
MA510-2040		30	112	110	40
MA510-2050		37	132	130	50
MA510-2060		45	163	160	60
MA510-2075		55	181	190	75
MA510-4001	3-phase 380V -+ 15%	0.75	3.4	2.5	1
MA510-4002		1.5	5	3.7	2
MA510-4003		2.2	5.8	5	3
MA510-4005		4	10	9	5
MA510-4008		5.5	15	13	7.5
MA510-4010		7.5	20	17	10
MA510-4015		11	26	25	15
MA510-4020		15	35	32	20
MA510-4025		18.5	38	37	25
MA510-4030		22	46	45	30

Model Number	Input Voltage	Rated Power	Rated input current	Rated output current	Compatible Motor
MA510-4040	3-phase 380V -+ 15%	30	62	60	40
MA510-4050		37	76	75	50
MA510-4060		45	90	90	60
MA510-4075		55	105	110	75
MA510-4100		75	140	150	100
MA510-4125		90	160	176	125
MA510-4150		110	210	210	150
MA510-4175		132	240	250	175
MA510-4215		160	290	300	215
MA510-4250		185	330	340	250

## Chapter 3 Environment and Installation

### 3.1 Environment

The installing environment of the inverter directly affects its functions and the service

life. Therefore, the installation environment must meet the following conditions:

Applicable environment	
Operating Temperature	(-10~40° C) (With the dust-protection cover open, the applicable operation temperature (-10~50° C) (full load) can reach maximum of 60° C) . But it is required to de-rating 2% of the rated current for increasing one degree. For multiple inverters installed side by side in the plate, please pay attention to the placement to facilitate heat
Storage Temperature	(-20~70C)
Humidity	RH should be 5% to 95%, free of condensation or water droplets.
Shock	Maximum acceleration:1.2G (12m/s <sup>2</sup> ), from 49.84 to 150 Hz Displacement amplitude : 0.3mm (peak value), from 10 to 49.84 Hz

## 3.2 Installation

### Installation site

The product shall be installed in the environment for easy operation, avoiding to be exposed to the following environments:

- Avoid direct sunlight
- Avoid rain drops or wet environment
- Avoid oil mist and salt erosion
- Avoid corrosive liquid and gas
- Avoid dust, lint fibers, and small metal filings.
- Avoid electromagnetic interference (soldering machine, power machine)
- Keep away from radioactive and flammable materials
- Avoid vibration (punch). Please add a vibration-proof pad to reduce vibration if it can not be avoided

#### 3.2.1 Installation Spaces

Please install the MA510 inverter in vertical direction, leaving enough space to ensure the cooling effect, shown in below Figure. Avoid the upside-down or horizontal installation.

The temperature of inverter's radiator cooling may reach 90 ° C in operation. Therefore, the contact surface for the inverter installation shall be made by the hightemperature-resistant material.

When the inverter is operating in the power distribution box, the environment must be ventilated and the environmental temperature must be less than +40 ° C.

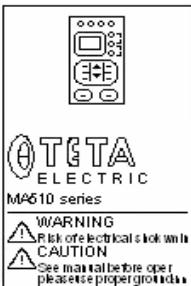

Up / Down	please leave 150mm
Left	for the inverter capacity of 18.5kW (including the smaller Kw),the minimum width recommended is 100mm.
Right side	for the inverter capacity of 22 kW (including the higher Kw), the minimum width recommended is 200mm.

### 3.2.2 External View and part description

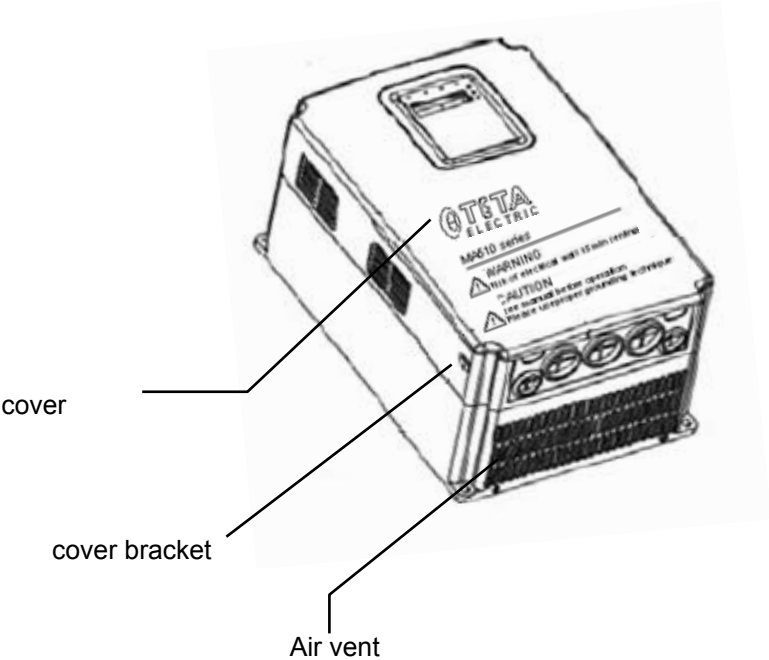

for capacities below 25 HP

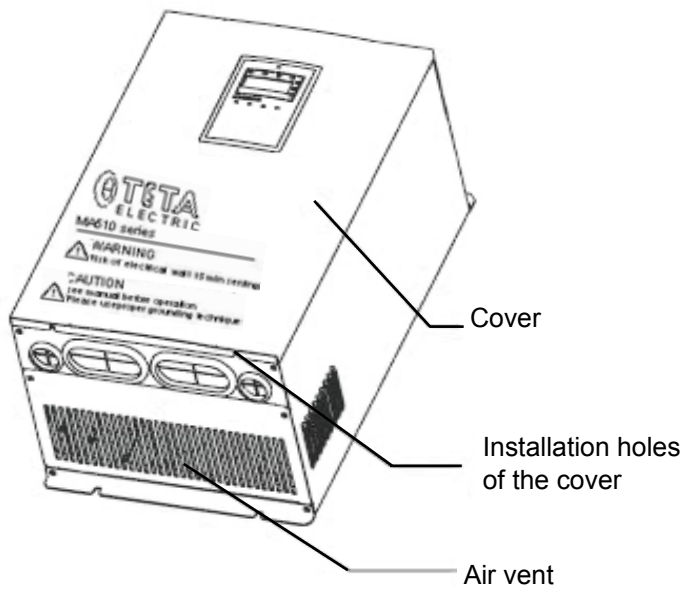
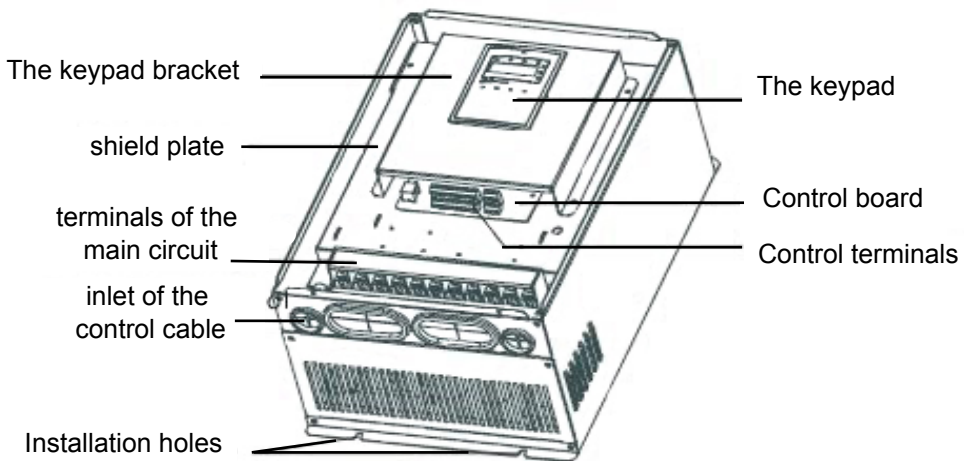

**for capacities above( and include ) 25 HP**

### 3.2.3 Unpacking inspection



#### Caution

Don't install or use any inverter that is damaged or has fault parts, otherwise physical injury may occur.

check the following items after unpacking the inverter

1. Inspect the entire exterior of the inverter and motor to ensure there are no scratches or other damage caused by the transportation
2. Ensure there is operation manual in the packing box
3. Inspect the name plate and ensure it is what you ordered.
4. Ensure the optional parts are what you need if you have ordered ones.

Please contact the local agent if there is any damage to the inverter or optional parts.

### 3.2.4 Disassemble and installation



#### Caution

- The dropping of the main part may cause physical injury .
- The inverter is fixed on a non-flammable wall such as metal and away from heat and flammable materials to avoid the fire.
  - If more than two drives are installed in a cabinet , the temperature should be lower than 40 by means of cooling fan. Overheat may cause fire or damage to the drive.



## Warning

Only qualified people are allowed to operate on the drive device/system. Ignoring the instructions in "warning" may cause serious physical injury or death or property loss.

1. After the power is cut off, while the "CHARGE" indicator of the inverter is still on, it means the discharge of the capacitor has not been completed. Don't touch the circuit or replace components at this time.
2. Never wire or disassemble/assemble internal connectors of inverter when the power is supplied.
3. Prohibit connecting U,V and W of inverter output terminals to AC power.
4. Terminal E of the inverter must be well grounded.
5. Since semiconductor components are easily damaged by high voltage, do not carry out the high voltage withstand test on internal components of MA510 inverter.
6. CMOS IC of the inverter control board is easily affected and damaged by static electricity, thus, do not touch the control board.
7. connect the input power lines tightly and permanently.



### 3.3 Inverter Wiring

#### 3.3.1 Wiring Peripheral Power Devices

Examples for wiring the periphery devices of MA510 are shown in the following:

Power supply



Circuit breaker



Electromagnetic contactor



AC reactor



Fast acting fuse



Input noise filter



Inverter



Zero-phase noise filter



3-phase induction motor

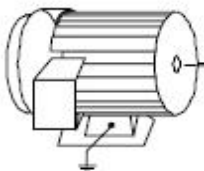

Electromagnetic contactor : It can not add for general use. However for the application requiring external sequence control or automatic restart function power cut, is required. Please avoid using it for the start/stop control of the inverter as possible.

AC reactor : In case of further improving the power factor or suppress the external surge , an AC reactor can be additionally equipped.

Fast acting fuse: To protect interface devices.

Input noise filter: The surrounding device may be disturbed when inverter is working. EMC filter can minimize the interface

Inverter : Terminal R,S,T at input side have no phase requirement, thus they can be arbitrarily exchanged. Terminal E must be well grounded

Zero-phase noise filter : Adding this at the output side of the inverter can be decrease the radiated interface and induced noise.

Motor : If an inverter drives multiple motors, the rated current of the inverter must be greater than the total current that all motors operate at the same time. Motor and inverter must be grounded respectively.

### 3.3.2 General Wiring Diagram

The following is the standard wiring diagram for the MA510 inverter. Locations and symbols of the wiring terminal block might be different due to different models.

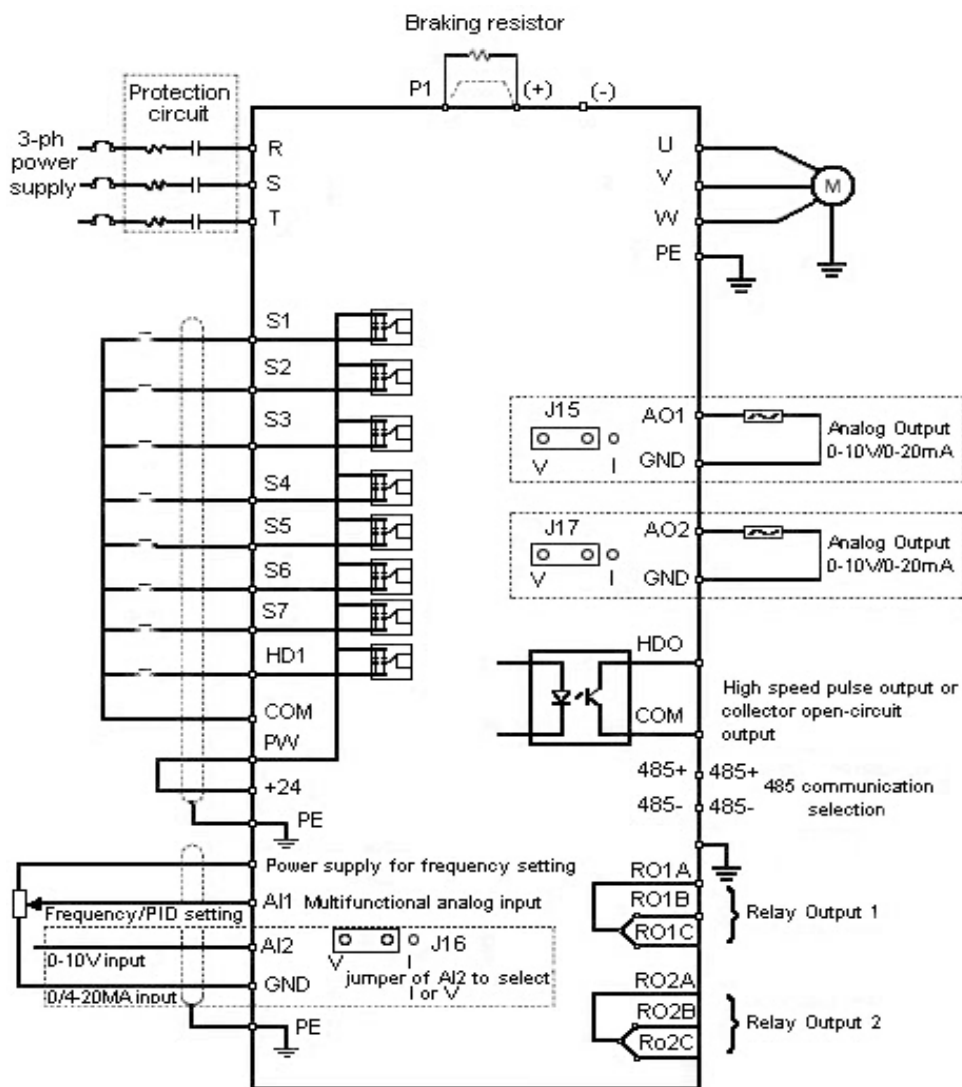

For Inverters  $\geq 18.5$  Kw

Only the master circuit of 380 V 1~20HP (included) or models of lower capacity with built-in braking resistor provide terminal PB. The braking resistor can be connected directly between (+) and PB.

The wire length of the braking resistor should be less than 5m.

Please pay attention to safety prevention and smooth ventilation when installing

braking resistors because the temperature will rise for the heat releasing.

The (+) and (-) terminals of the braking units corresponds to the (+) and (-) terminals of the inverter when the external braking unit is connected.

The wiring length between the (+) and (-) terminals of the inverter and the (+), (-) of the braking units should not be more than 5m and the distributing length among BR1 and BR2 and the braking resistor terminals should not be more than 10m.



### Caution

Be sure that the electric polarity of (+) (-) terminals is right; it is not allowed to connect (+) with (-) terminals directly, otherwise damage or fire may occur.

### 3.3.3 Terminal description

#### Major Circuit Terminals

Terminal	function discription
R S T	Terminals of 3phase AC input
(+) (-)	spare terminals of external braking unit
(+) PB	spare terminals of external braking resistor
P1 (+)	spare terminals of external DC reactor
(-)	terminal of negative DC bus
(+)	terminal of positive DC bus
U V W	Terminals of 3phase AC output
	terminal of ground

**2 ~ 3 HP , 380 V**



**5 ~ 7.5 HP , 220 / 380 V**

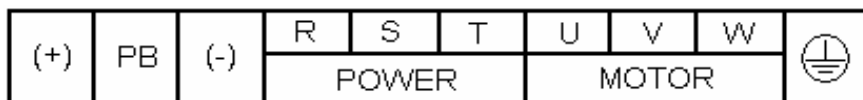

**10 ~ 20 HP , 380 V / 10HP 220 V**

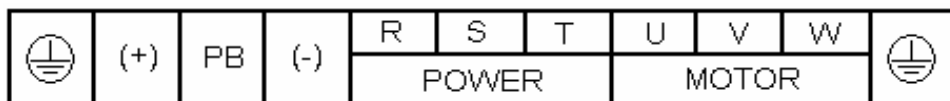

**25 ~ 150 HP , 380 V / 15 ~ 20 HP 220V**

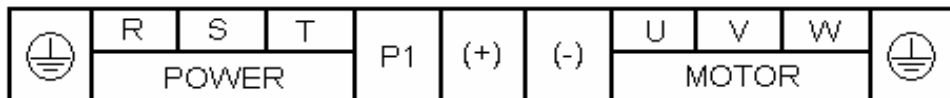

**175 ~ 250 HP , 380 V**

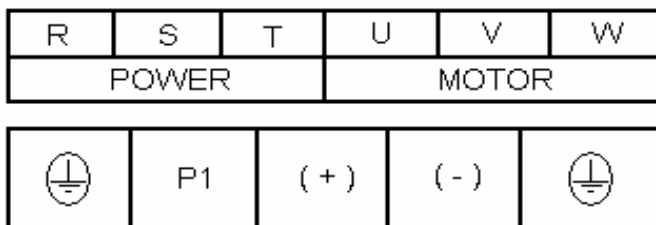

### Control Circuit Terminals

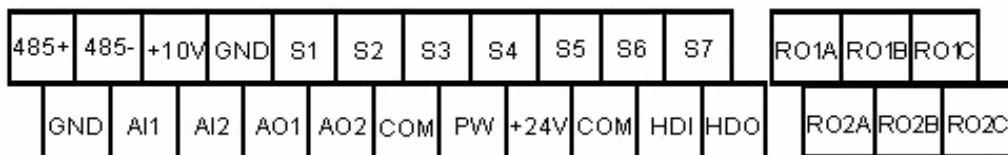

Type	Terminal	Terminal function	Signal level
Digital Input	S1~S7	ON-OFF signal input, optical coupling with PW and COM	24VDC,8mAoptocoupler isolation (maximum voltage of 30Vdc, input impedance of 3.3k $\Omega$ )
24V Power supply	(+24v)	Digital signal SOURCE sharing point (PW switched to SOURCE)	$\pm 15\%$ , Maximum output current: 150mA
	COM	Common terminal of Digital signals (PW switched to SINK)	( the sum of all load )
External power supply	PW**	(+24v) terminal is connected to PW terminal as default*	default (+24v)
Pulse input signal	HDI	Pulse or ON-OFFinput ,optical coupling with PW and COM	frequency range:0~50kHz Input voltage:9~30V Input impedance:1.1K $\Omega$
Analog input signal	A11	Voltage speed command	(-10v~+10v)Input impedance:20K $\Omega$
	A12	Multi-function analog input terminal switched by J16	From 0V ~ +10V / 0 ~ 20mA Input impedance: 10K $\Omega$ (voltage) / 250 $\Omega$ (current)
	(+10v)	Power for speed setting	
	GND	Analog signals sharing terminal	
Pulse output signal	HDO	high speed pulse or open collector output. The corresponding common terminal is COM	Output frequency range: 0 ~ 50kHz
Analog output signal	AO1	analog output terminals above 5HP: AO1 by J15 and AO2 by J17	Output range :
	AO2	2~3HP: AO1 by J15 and AO2 by J14 can be selected	Voltage (0 ~ 10v) current (0 ~ 20mA)
RS-485 port	+485	RS-485 / MODBUS***	Opto-coupler isolation, differential input and output
	-485		

Type	Terminal	Terminal function	Signal level
Relay Output	RO1A	RO1 common	Contact capacity : AC 250V / 3A    DC 30V / 1A
	RO1B	RO1 normally close(NC)	
	RO1C	RO1 normally open(NO)	
	RO2A	RO2 common	
	RO2B	RO2 normally close(NC)	
	RO2C	RO2 normally open(NO)	

\*If the external power supply is needed , disconnect (+24v) with PW terminal and connect external power supply

\*\*Using of PW to set sink or source mode

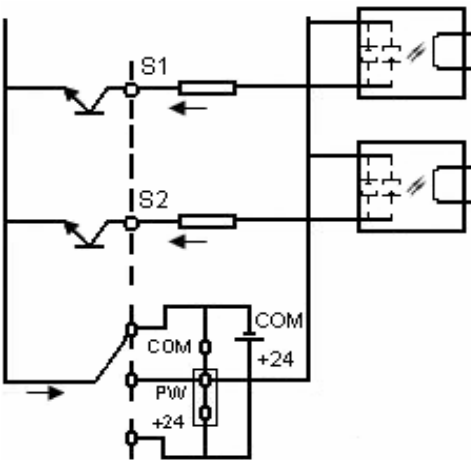

sink mode

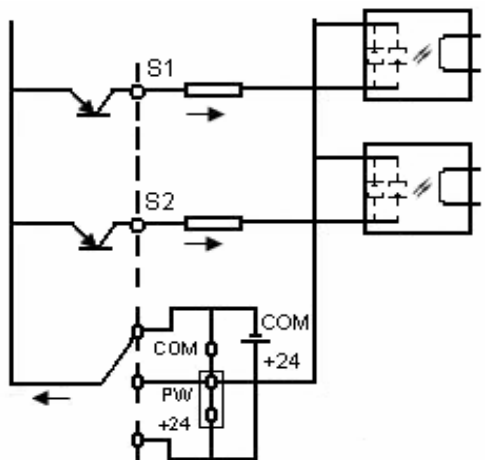

source mode

\*\*\*Please use twisted pairs and shield cables on the standard communication port

Jumper	Description
J2 , J4	It is prohibited to be connected together , otherwise it will cause inverter malfunction.
J16	switch between 0~10v and 0~20mA Input V connect to GND means voltage input I connect to GND means current input
J15 and J17 above 5HP	switch between 0~10v and 0~20mA Output V connect to GND means voltage output I connect to GND means current output
J14 and J15 2HP~3HP	switch between 0~10v and 0~20mA Output V connect to GND means voltage output I connect to GND means current output
SW1	Switch of terminal resistor for RS-485 communication , dialing to ON means connecting to terminal resistor while dialing to OFF means disconnecting to terminal resistor.(only valid for 5HP and above)
J7	RS-485 communication jumper
J17 and J18 2HP~3HP	Switch of terminal resistor for RS-485 communication. Jumper enable: connect terminal resistor Jumper disable: Disconnect terminal resistor

### 3.3.4 Wiring Precautions

For the external wiring of the control terminal, please attention to the followings:

Use shield or twisted-pair cables to connect control terminals.

The cable connected to the control terminal should be left away from the main circuit and strong current circuits (including power supply cable, motor cable, relay and contactor connecting cable) at least 20cm , and parallel wiring should be avoided. It is suggested to apply perpendicular wiring to prevent inverter malfunction caused by external interference.

Contact output terminal R1A, R1B, R1C (or R2A,R2B, R2C) must be isolated from terminal 1 ~ 7, A01, A02, GND, HDO, COM, +10V, AI1, AI2, HD1 when wiring.

In order to avoid the electrical noise interference, the control circuit wiring must adopt shielding isolation twisted wire, please refer to the following diagram; the wiring distance should not exceed 50m.

Connect the ground terminal(PE) with shield wire.

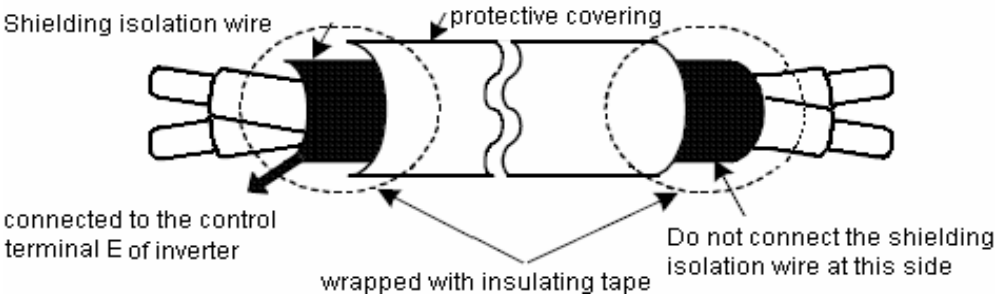

When connecting the output contact of the multi-function optocoupler to the relay, it is necessary to add flywheel diode in parallel to both sides of the relay coil, as shown in the following diagram.

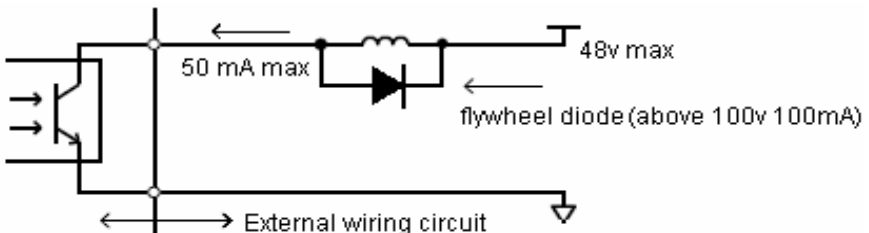



For the wiring of the main circuit terminal, please attention to the followings:

It doesn't need to consider the phase sequence for input power R, S, T.

Prohibit connecting U,V and W of inverter output terminals to AC power.

Inverter output terminal U, V and W are connected to the motor terminal U, V, W. If the inverter executes forward rotation instruction while the motor rotates in reversal direction, simply exchange any two wires of U, V, W is enough.

Never connect the inverter output terminal to the capacitor or LC,RC noise filter of improving the power factor.

Grounding terminal (E) is grounded to the earth by the third type grounding way.

(grounding resistance of  $100\Omega$  or less)

Inverter grounding wire can not be grounded together with high - current loads such as welding machines and high-powered motors and so on. They must be grounded respectively.

Grounding wire size follows the specification of electrical equipment technical basisThe shorter grounding wire is, the better it is.

If several inverters are grounded jointly , please refer to the following diagrams for grounding. Do not form a circuit in grounding.

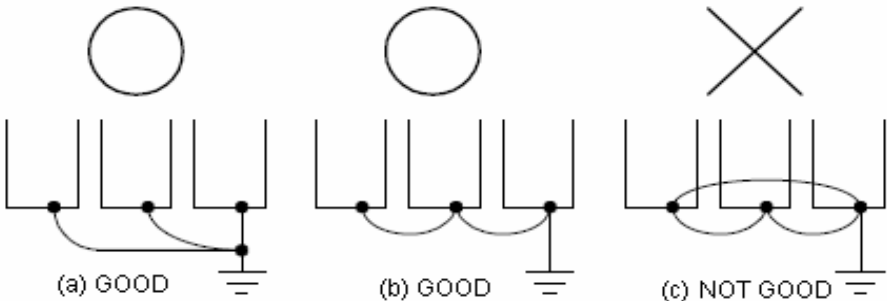

## Determine wire size:

When choosing wire, a consideration of the voltage drop caused by the wire is a must.

Voltage drop is calculated as shown below. In general, the voltage drop shall be controlled below 2% of the rated voltage. Voltage drop between wires (V) =  $\times$  wire resistance ( $\Omega$  / km)  $\times$  wiring length (m)  $\times$  current (A)  $\times 10^{-3}$

## AC reactor for parallel power coordination:

If the capacity exceeds 600kVA, please add AC reactor to the input side of the inverter in series. AC power can be used for power coordination and power factor improvement.

## Wiring length between the inverter and the motor:





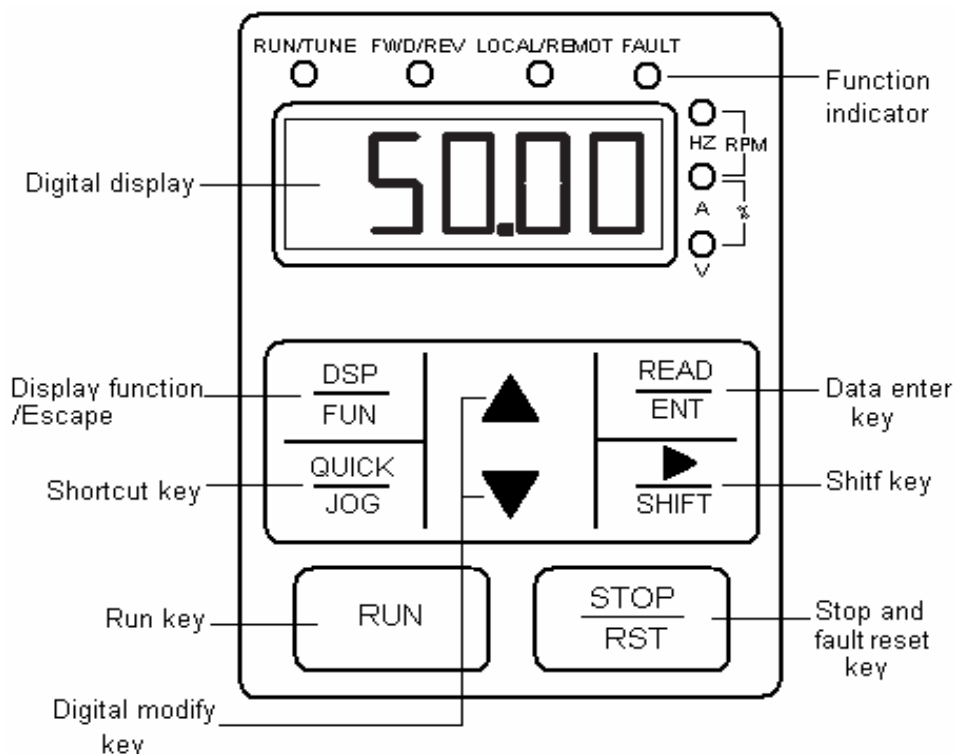

If the total length between the inverter and the motor, the inverter itself and other peripheral devices will be affected because the high-frequency carrier frequency(the IGBT ON / OFF switching frequency) of the inverter will increase the leakage current between wiring and the ground. As a result, if the wiring length between the inverter and the motor is very long, please modestly reduce the carrier frequency, as shown below.

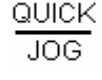

Wiring distance between the inverter and the motor	< 30m	30m ~ 50m	50m~100m	$\geq$ 100m
Allowable carrier frequency (set values of P0-14 )	15kHz(max)	10kHz(max)	5kHz(max)	2kHz(max)

## Chapter 4 Keypad and Programming Functions



Key	Name	Function Description
<u>DSP</u> FUN	Display function/Escape	Enter or escape from the first level menu
<u>READ</u> ENT	Read enter key	Progressively enter menu and confirm parameter
▲	Digital modify key	Progressively increase data or function codes
▼	Digital modify key	Progressively decrease data or function codes
▶ SHIFT	shift key	In parameter setting mode , press this button to select the bit to be modified in in other modes cyclically displays parameters by right shift

Key	Name	Function Description
	Run key	Start to run the inverter in keypad control mode
	Stop / Reset key	In running status, registered by P7.04, can be used to stop the inverter. When fault alarm, can be used to reset the inverter without any restriction
	Shortcut key	Determined by function code P7.03 : 0 : Display status switching 1 : Jog operation 2 : Switch between forward and reverse 3 : Clear the UP/DOWN terminals settings 4 : Quick debugging mode
	Combination key	Pressing the  and  at the same time can achieve inverter coast to stop

Function indicator	Description
RUN/TUNE 	Extinguished : Stop status Flickering : Parameter auto tuning status Light on : Operating status
FWD/REV 	Extinguished : Forward operation Light on : Reverse operation
LOCAL/REMOT 	Extinguished : Keypad control Flickering : Terminal control Light on : Communication control

Function indicator	Description
FAULT ●	Extinguished : Normal operation status Flickering : Over load pre-warning status Light on : Fault of the inverter
HZ	Frequency unit
A	Current Unit
V	Voltage unit
RPM	Rotating speed unit
%	Percentage

### 4.4.1 Keypad Operation Description

#### 4.4.1.1 Parameter setting

Press either the **PRG/ESC** or the **DATA/ENT** can return to the second - level menu from the third-level menu. The difference is: pressing **DATA/ENT** will save the set parameters in to the control panel, and then return to the second-level menu with shifting to the next function code automatically. While pressing **PRG/ESC** will return to the second-level menu without saving parameters, and keep staying at the current function code.

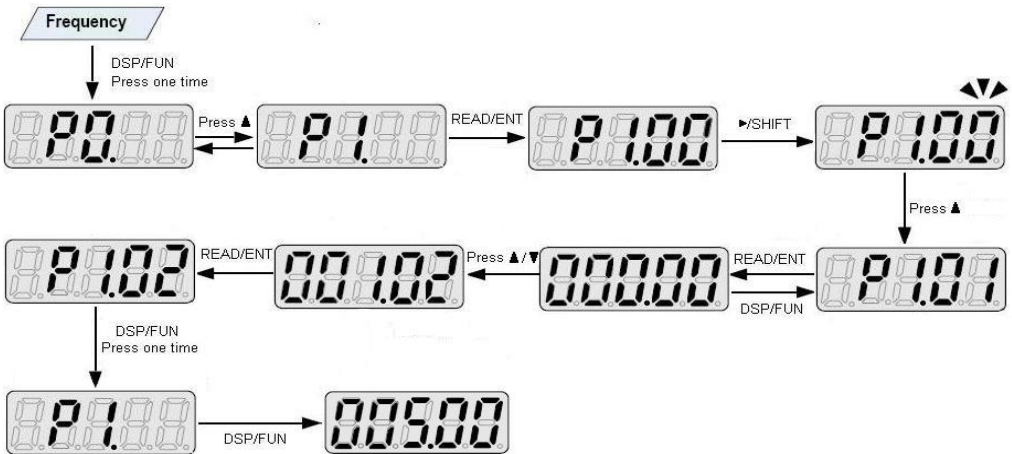

Under the third - level menu , if the parameter has no flickering bit, it means the function code can not be modified. The possible reasons could be:

this function is not modifiable parameter, such as actual detected parameter operation records and so on.

this function is not modifiable in running mode.

### **Short cut menu** QUICK/JOG

Short cut menu provides a quick way to view and modify function parameters.

set the P7.03 to 4,then press QUICK/JOG , the inverter will search the which is different from the factory setting , save these data beyond 32,parameter it can not display the overlength part . Press QUICK/JOG will be shortcut debugging mode. If the QUICK/JOG displays "NULLP",it means the parameters are the same with the factory setting.

If want to return to last display , press QUICK/JOG

### **Fault reset**

If fault occurs to the inverter , it will inform the related fault information . User can use STOP/RST or according terminals determined by P5 group to reset fault.

After fault reset, the inverter is in stand - by state. If user does not reset the fault the inverter will be in operation protection state, and can not run.

# Chapter 5 Overall Dimension drawing

## Standard model

(a) 380V : 20HP ~ 40HP

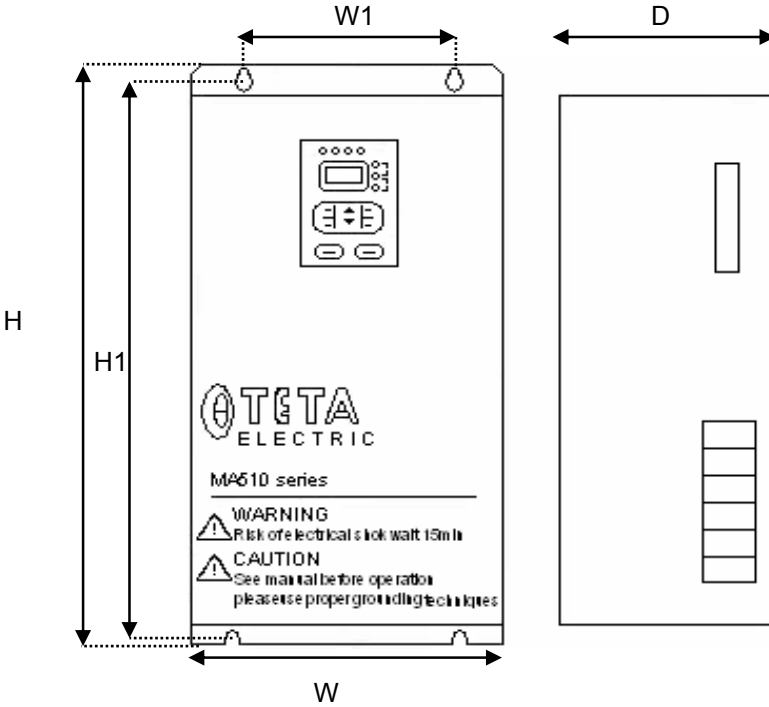

Inverter Model	Dimension (mm)					
	W	H	D	W1	H1	GW(kg)
MA510 4025	290	470	215	175	460	12
MA510 4030	290	470	215	175	460	12
MA510 4040	290	470	215	175	460	12

(b) 380V : 50HP ~ 75HP

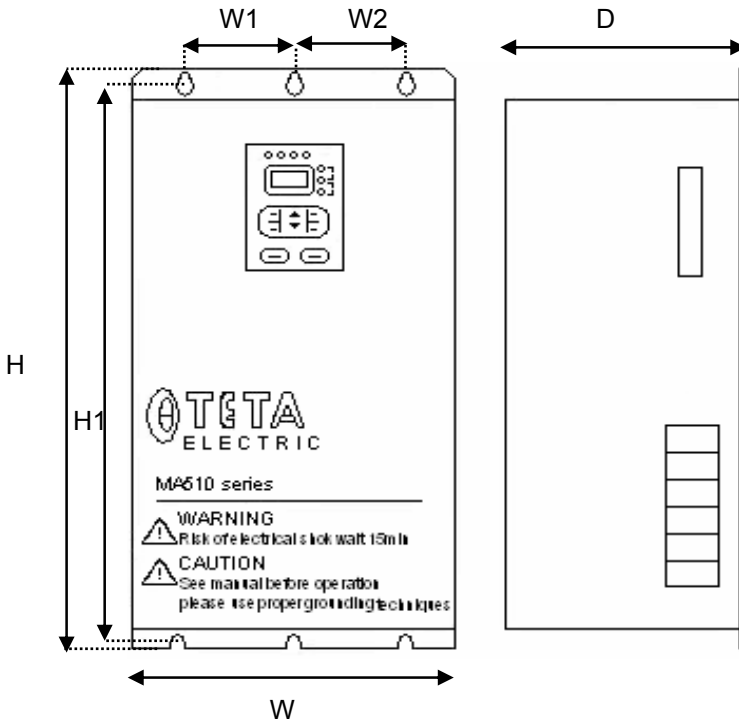

Inverter Model	Dimension (mm)					
	W	H	D	W1/W2	H1	GW(kg)
MA510 4050	375	585	270	115	665	36
MA510 4060	375	585	270	115	665	36
MA510 4075	375	585	270	115	665	36



(c) 380V : 100HP ~ 150HP

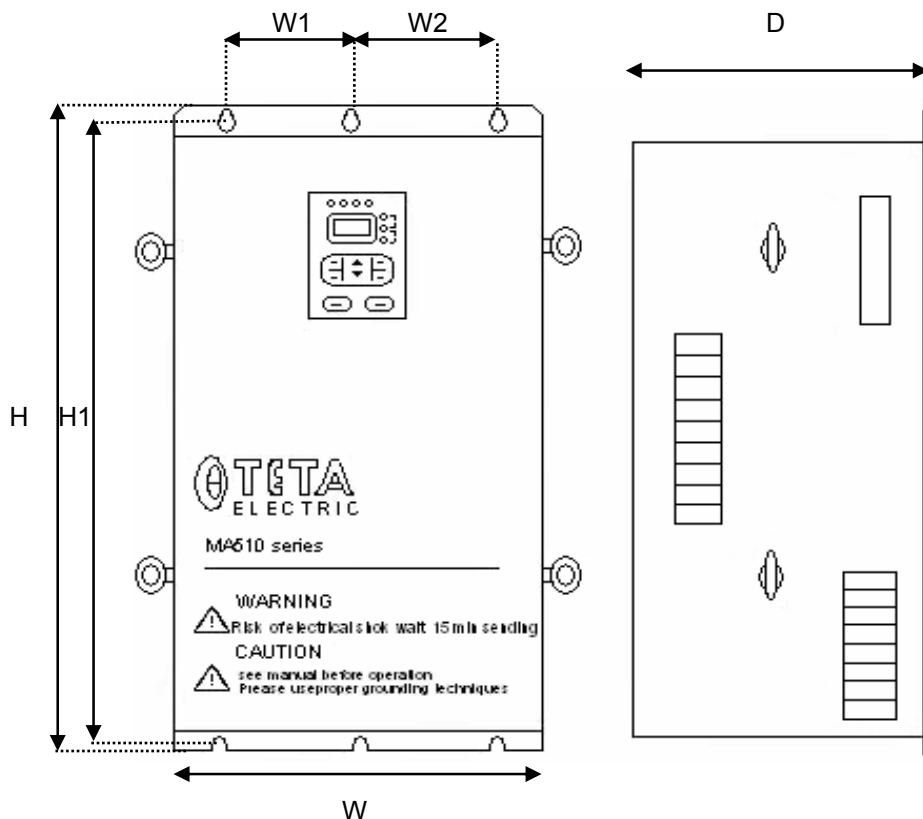

Inverter Model	Dimension (mm)					
	W	H	D	W1/W2	H1	GW(kg)
MA510 4100	460	755	330	160	735	48
MA510 4125	460	755	330	160	735	48
MA510 4150	460	755	330	160	735	50

# Keypad Dimension

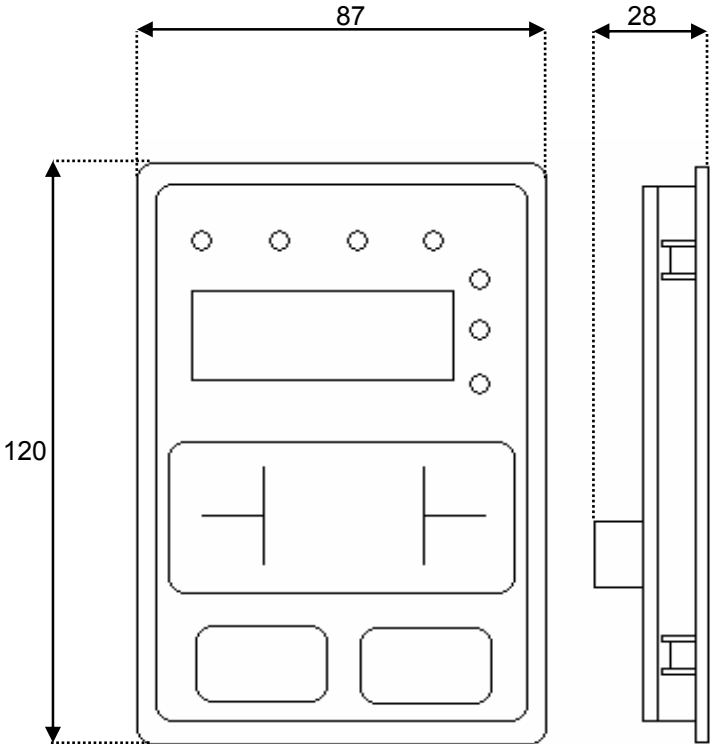

## Chapter 6 Braking resistor

Model Number	Input Voltage	Braking Resistor	used number	Braking Unit	used number
MA510-2002	3-phase 220V +- 15%	260W/130Ω	1	----	0
MA510-2003		260W/80Ω	1	----	0
MA510-2005		400W/48Ω	1	----	0
MA510-2008		550W/35Ω	1	----	0
MA510-2010		780W/26Ω	1	----	0
MA510-2015		1100W/17Ω	1	----	0
MA510-2020		1800W/13Ω	1	----	0
MA510-2025		2000W/10Ω	1	70	1
MA510-2030		2500W/8Ω	1	80	1
MA510-2040		1800W/13Ω	2	110	2
MA510-2050		2000W/10Ω	2	130	2
MA510-2060		2500W/8Ω	2	160	2
MA510-2075		3000W/6.5Ω	2	190	2
MA510-4002	3-phase 380V +- 15%	260W/400Ω	1	----	0
MA510-4003		390W/150Ω	1	----	0
MA510-4005		390W/150Ω	1	----	0
MA510-4008		520W/100Ω	1	----	0
MA510-4010		1040W/50Ω	1	----	0
MA510-4015		1040W/50Ω	1	----	0
MA510-4020		1560W/40Ω	1	----	0
MA510-4025		6000W/20Ω	1	37	1
MA510-4030		6000W/20Ω	1	45	1
MA510-4040		6000W/20Ω	1	60	1
MA510-4050		9600W/13.6Ω	1	75	1
MA510-4060		9600W/13.6Ω	1	90	1
MA510-4075		9600W/13.6Ω	1	110	1

Model Number	Input Voltage	Rated Power	Rated input current	Rated output current	Compatible Motor
MA510-4100		9600W/13.6Ω	2	150	2
MA510-4125		9600W/13.6Ω	2	176	2
MA510-4150		9600W/13.6Ω	2	210	2
MA510-4175		3000W/4Ω	1	250	1
MA510-4215		3000W/4Ω	1	300	1
MA510-4250		4000W/3Ω	1	340	1

In the installation of braking module and braking resistor, you need to keep an appropriate distance from the inverter, and maintain a good ventilation of the installation environment.

select the resistor and power of the braking unit according to the data our company provided.

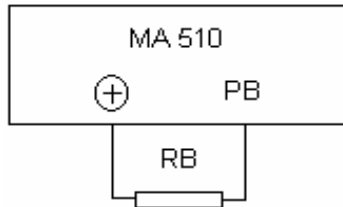

External braking resistor

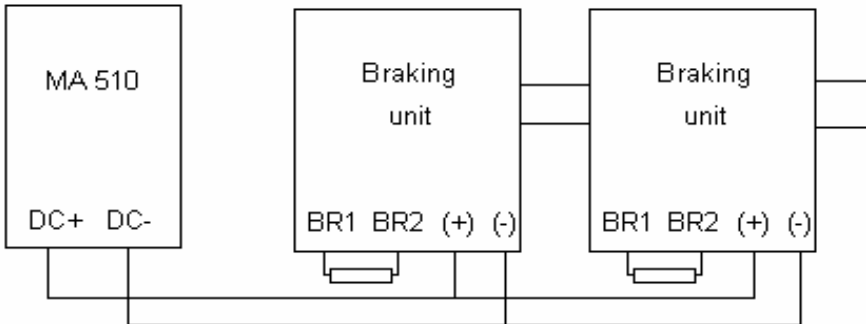

External braking unit  
Parallel

## Chapter 7 Parameters List

Parameter group	Name
P0 Group	Basic function
P1 Group	Start and Stop Control
P2 Group	Motor Parameters
P3 Group	Vector Control
P4 Group	V/F Control
P5 Group	Input Terminals
P6 Group	Output Terminals
P7 Group	Human and Machine Interface
P8 Group	Enhanced Function
P9 Group	PID Control
PA Group	Simple PLC and Multi-step Speed Control
PB Group	Protection Function
PC Group	serial communication
PD Group	Supplementary Function
PE Group	Factory Setting

<b>P0 Group : Basic function</b>				
Function	Name	Description	Setting	Default
P0.00	Control	0: V/F control 1: Sensorless vector control 2: Torque control (sensorless vector control)	0~2	0
P0.01	Run command source	0: Keypad (LED extinguished) 1: Terminal (LED flickering) 2: Communication(LED lights on)	0~2	0
P0.02	Keypad and Terminal UP/DOWN setting	0: Valid, save UP/DOWN value when Power off 1: Valid, do not save UP/DOWN value when power off 2: Invalid 3: valid during running, clear when stop.	0~3	0
P0.03	Maximum frequency	10.00~400.00Hz	10.00 ~ 400.00Hz	50.00Hz
P0.04	Upper frequency Limit	P0.05~P0.03 (the Maximum frequency)	P0.05 ~ P0.03	50.00Hz
P0.05	Lower frequency Limit	0.00~P0.04 (Lower frequency Limit)	P0.05 ~ P0.04	0.00Hz
P0.06	Keypad Reference Frequency	0.00~P0.03 (the Maximum frequency)	0.00 ~ P0.03	50.00Hz

Function	Name	Description	Setting	Default
P0.07	Frequency A command source	0: keypad 1: AI1 2: AI2 3: HDI 4: simple PLC 5: Multi-stage speed 6: PID 7: Remote communication	0~7	0
P0.08	Frequency B command Source	0: AI1 1: AI2 2: HDI	0~2	0
P0.09	Scale of frequency B command	0: maximum frequency 1: Frequency A command	0~1	0
P0.10	Frequency command selection	0: A 1: B 2: A+B 3: Max(A and B)	0~3	0
P0.11	Acceleration time 0	0.1~3600.0s	0.1 ~ 3600.0s	Depend On model
P0.12	Deceleration time 0	0.1~3600.0s	0.1 ~ 3600.0s	Depend On model
P0.13	Running direction selection	0: forward 1: reverse 2: forbid reverse	0~2	0
P0.14	Carrier frequency	1.0~15.0kHz	1.0 ~ 15.0kHz	Depend On model

Function	Name	Description	Setting	Default
P0.15	AVR function	0: Invalid 1: valid all the time 2: only valid in deceleration	0~2	1
P0.16	Motor parameters autotuning	0: No action 1: Rotation autotuning 2: static autotuning	0~3	2
P0.17	Restore parameters	0: No action 1: Restore factory setting 2: Clear fault records	P0.17	P0.17
<b>P1 Group: Start and Stop Control</b>				
P1.00	Start Mode	0: Start directly 1:DC braking and start 2:Speed tracking and start	0.2	0
P1.01	Starting frequency	0.00~10.00Hz	0.00 ~ 10.00	0.00Hz
P1.02	Hold time of starting frequency	0.0~50.0s	0.0~50.0	0.0s
P1.03	DC Braking Current Before start	0.0~150.0%	0.0~150.0	0
P1.04	DC Braking time before start	0.0~50.0s	0.0~50.0	0.0s
P1.05	Acceleration	0: Linear	0~1	0



Function	Name	Description	Setting	Default
	Deceleration mode	1: reserved		
P1.06	Stop mode	0: Decelerate to stop 1: Coast to stop	0~1	0
P1.07	Starting frequency of DC braking	0.00~P0.03	0.00 ~ P0.03	0.00Hz
P1.08	Waiting time before DC braking	0.0~50.0s	0.0~50.0	0.0s
P1.09	DC braking current	0.0~150.0s	0.0~150.0	0
P1.10	DC braking time	0.0~50.0s	0.0~50.0	0.0s
P1.11	Dead time of FWD/REV	0.0~3600.0s	0.0 ~ 3600.0	0.0s
P1.12	Action when running frequency is less than lower frequency limit (valid when lower frequency limit is above 0)	0: Running at the lower frequency limit 1: stop 2: stand-by	0~2	0

Function	Name	Description	Setting	Default
P1.13	Delay time for restart	0.0~3600.0s (valid when P1.12=2)	0.0 ~ 3600.0	0
P1.14	Restart after power off	0: Disabled 1: Enabled	0~1	0
P1.15	Waiting time of restart	0.0~3600.0s (valid when P1.14=1)	0.0 ~ 3600.0	0.0s
P1.16	Terminal detection selection when power is on	0: Disabled 1: Enabled	0~1	0
P1.17	Reserved			
P1.18	Reserved			
P1.19	Reserved			
<b>P2 Group: Motor Parameters</b>				
P2.00	Inverter model	0: G model 1: P model	0~1	Depend on model
P2.01	Motor rated power	0.4~900.0kW	0.4 ~ 3000.0	Depend on model
P2.02	Motor rated frequency	0.01Hz~P0.03	10.00 ~ P0.0	50.00Hz
P2.03	Motor rated speed	0~36000rpm	0.0 ~ 3600.0	Depend on model
P2.04	Motor rated voltage	0~800V	0~800	Depend on model
P2.05	Motor rated current	0.8~6000.0A	0.8 ~ 6000.0	Depend on model

Function	Name	Description	Setting	Default
P2.06	Motor stator resistance	0.001~65.535Ω	0.001 ~ 65.535	Depend on model
P2.07	Motor rotor resistance	0.001~65.535Ω	0.001 ~ 65.535	Depend on model
P2.08	Motor leakage inductance	0.1~6553.5mH	0.1 ~ 6553.5	Depend on model
P2.09	Motor leakage inductance	0.1~6553.5mH	0.1 ~ 6553.5	Depend on model
P2.10	Current without load	0.1~6553.5A	0.1 ~ 6553.5	Depend on model

### P3 Group: Vector Control

P3.00	ASR proportional gain Kp1	0~100	0~100	20
P3.01	ASR integral time Kp1	0.01~10.00s	0.01 ~ 10.00	0.50S
P3.02	ASR switching point 1	0.00Hz~P3.05	0.00 ~ P3.05	5.00Hz
P3.03	ASR proportional gain Kp2	0~100	0~100	25
P3.04	ASR integral time Kp2	0.01~10.00s	0.01 ~ 10.00	1.00s

Function	Name	Description	Setting	Default
P3.05	ASR switching point 2	P3.02~P0.03 (the Maximum frequency)	P3.02 ~ P0.03	10.00Hz
P3.06	Slip compensation rate of VC	50.0%~200.0%	50~200	100%
P3.07	Torque upper limit	0.0~200% (the rated current of the inverter)	0.0~200.0	G model: 150.00% P model: 120.00%
P3.08	Torque setting source	0: Keypad (corresponds to P3.09) 1: AI1 2: AI2 3: HDI 4: Multi-step speed 5: Remote communication (1~5: 100% corresponds to 2 times of the rated current of the inverter)	0~5	0
P3.09	Keypad torque setting	(-200.0%~200.0%) (the rated current of the inverter)	(-200.0% ~200.0%)	50.00%
P3.10	Upper frequency setting source	0: Keypad (P0.04) 1: AI1 2: AI2 3: HDI 4: Multi-step 5: Remote communication (1~4: 100% corresponds to the max. Frequency)	0~5	0

P4 Group: V/F Control				
Function	Name	Description	Setting	Default
P4.00	V/F curve selection	0: Linear curve 1: Multidots curve 2: torque_stepdown curve (1.3 order) 3: Torque_stepdown curve (1.77 order) 4: Torque_stepdown curve (2.0 order)	0~4	0
P4.01	Torque boost	0.0%: (auto) 0.1%~10.0%	0.0 ~ 10.0	0.00%
P4.02	Torque boost cut-off	0.0%~50.0% (motor rated frequency)	0.0 ~ 50.0	20.00%
P4.03	V/F frequency 1	0.00Hz~P4.05	0.00 ~ P4.05	0.00Hz
P4.04	V/F voltage 1	0.0%~100.0% (the rated voltage of the motor)	0.0 ~ 100.0	0.00%
P4.05	V/F frequency 2	P4.03~P4.07	P4.03 ~ P4.7	0.00Hz
P4.06	V/F voltage 2	0.0%~100.0% (the rated voltage of the motor)	0.0 ~ 100.0	0.00%
P4.07	V/F frequency 3	P4.05~ P2.02 (the rated frequency of the motor)	P4.05 ~ P2.02	00.00Hz
P4.08	V/F voltage 3	0.0%~100.0% (the rated voltage of the motor)	0.0 ~ 100.0	0.00%
P4.09	Slip compensation limit	0.00~200.0%	0.0~200	0.00%

Function	Name	Description	Setting	Default
P4.10	Auto energy saving selection	0: Disabled 1: Enabled	0~1	0
P4.11	Low-frequency threshold of restraining oscillation	0~10	0~10	2
P4.12	High-frequency threshold of restraining oscillation	0~10	0~10	0
P4.13	Boundary of restraining oscillation	0.0~P3.03	0.00 ~ P0.03	30.00Hz

### P5 Group: Input Terminals

P5.00	HDI selection	0: High speed pulse input 1: ON-OFF input	0~1	0
P5.01	S1 Terminal function	0: Invalid 1: Forward	0~39	1
P5.02	S2 Terminal function	2: Reverse 3: 3-wire control	0~39	4
P5.03	S3 Terminal function	4: Jog forward 5: Jog reverse	0~39	7
P5.04	S4 Terminal function	6: Coast to stop 7: Reset fault	0~39	0
P5.05	S5 Terminal function	8: Pause running 9: External fault input	0~39	0

Function	Name	Description	Setting	Default
P5.06	S6 Terminal function	10: UP command 11: DOWN command	0~39	0
P5.07	S6 Terminal function	12: Clear UP/DOWN 13: Switch between A and B	0~39	0
P5.08	HDI Terminal function	14: Switch between A and A+B 15: Switch between B and A+B 16: Multi-step speed reference1 17: Multi-step speed reference2 18: Multi-step speed reference3 19: Multi-step speed reference4 20: Multi-step speed pause 21: ACC/DEC time selection 1 22: ACC/DEC time selection 2 23: Reset simple PLC when stop 24: Pause simple PLC 25: Pause PID 26: Pause traverse operation 27: Pause traverse operation 28: Reset counter 29: reset length 30: ACC/DEC ramp hold 31: Counter input 32: UP/DOWN invalid temporarily 33-39: Reserved	0~39	0
P5.09	ON-OFF filter times	1~10	1~10	5

Function	Name	Description	Setting	Default
P5.10	Terminal control mode	0: 2-wire control mode 1 1: 2-wire control mode 2 2: 3-wire control mode 1 3: 3-wire control mode 2	0~3	0
P5.11	UP/DOWN setting change rate	0.01~50.00Hz/s	0.01~50.0 0	0.50Hz/s
P5.12	AI1 lower limit	0.00V~10.00V	-10.00~10.	0.00V
P5.13	AI1 lower limit corresponding setting	-100.0%~100.0%	-100.0~100	0.00%
P5.14	AI1 lower limit	0.00V~10.00V	-10.00~10.	10.00V
P5.15	AI1 lower limit corresponding setting	-100.0%~100.0%	-100.0~100	100.00%
P5.16	AI1 filter time constant	0.00s~10.00s	0.00~10.00	0.10s
P5.17	AI2 lower limit	0.00V~10.00V	0.00~10.00	0.00V
P5.18	AI2 lower limit corresponding setting	-100.0%~100.0%	-100.0~100	0.00%



Function	Name	Description	Setting	Default
P5.19	AI2 upper limit	0.00V~10.00	0.000~10.0	10
P5.20	AI2 upper limit corresponding setting	-100.0%~100.0%	-100.0~100	100.00%
P5.21	AI2 filter time constant	0.00s~10.00s	0.00~10.00	0.10s
P5.22	HDI lower limit	0.0kHz	0.00~50.00	0.00kHz
P5.23	HDI lower limit corresponding setting	-100.0%~100.0%	-100.0~100	0.00%
P5.24	HDI upper limit	0.0kHz~50.0kHz	0.00~50.00	50.00kHz
P5.25	HDI lower limit setting	-100.0%~100.0%	-100.0~100	100%
P5.26	HDI filter time constant	0.00s~10.00s	0.00~10.00	0.10s
<b>P6 Group: Output Terminals</b>				
P6.00	HDO selection	0: No output 1: Running	0~1	0
P6.01	HDO ON-OFF Output selection	2: Run forward 3: Run reverse 4: Fault output	0~20	1

Function	Name	Description	Setting	Default
		5: FDT reached 6: Frequency reached 7: Zero speed running 8: Preset count value reached 9: Specified count value reached 10: Length reached 11: Simple PLC step completed 12: PLCcycle completed 13: Running time reached		
P6.02	Relay 1 output selection	14: Upper frequency limit reached 15: Lower frequency limit reached 16: Read	0~20	4
P6.03	Relay 2 output selection	17: Auxiliary motor 1 started 18: Auxiliary motor 2 started 19~20: Reserved	0~20	0
P6.04	AO1 function selection	0: Running frequency 1: Reference frequency 2: Rotation speed	0-10	0
P6.05	AO2 function selection	3: Output current 4: Output voltage	0-10	0
P6.06	HDO function selection	5: Output power 6: Output torque 7: AI1 voltage 8: AI2 voltage/current 9: HDI frequency	0-10	0
P6.07	AO1 lower limit	0.0%~100%	0.0~100.0	0.00%

Function	Name	Description	Setting	Default
P6.08	AO1 lower limit corresponding output	0.00V~10.00V	0.00~10.00	0.00V
P6.09	AO1 upper limit	0.00V~10.00V	0.0~100.0	100.00%
P6.10	AO1 upper limit corresponding output	0.00V~10.00V	0.00~10.00	10.00V
P6.11	AO2 lower limit	0.0~100.0%	0.0~100.0	0.00%
P6.12	AO2 lower limit corresponding output	1~10.00V	0.00~10.00	0.00V
P6.13	AO2 upper limit	0.0~100.0%	0.0~100.0	100.00%
P6.14	AO2 upper limit corresponding output	0.00~10.00V	0.00~10.00	10.00V
P6.15	HDO lower limit	0.00%~100.00%	0.00~100.0	0.00%
P6.16	HDO lower limit corresponding output	0.000~50.000KHz	0.000~50.0	0.00KHz

Function	Name	Description	Setting	Default
P6.17	HDO upper limit	0.00%~100.00%	0.000~100.	100.00%
P6.18	HDO upper limit corresponding output	0.0~50.0KHz	0.000~50.0	50.00KHz
<b>P7 Group: Human and Machine Interfaces</b>				
P7.00	User password	0~65535	0~65535	0
P7.01	Reserve		Reserved	Reserved
P7.02	Reserve		Reserved	Reserved
P7.03	<u>QUICK/JOG</u> function selection	0: Display status switching 1: Jog 2: FWD/REV switching 3: Clear UP/DOWN setting 4: QUICK set mode	0~4	0
P7.04	<u>STOP/RST</u> function selection	0: Valid when keypad control (P0.03=0) 1: Valid when keypad or terminal control (P0.03=0 or 1) 2: Valid when keypad or communication control (P0.03=0 or 2) 3: Always valid	0~3	0
P7.05	Keypad display selection	0: Preferential to external keypad 1: Both display, only external key valid. 2: Both display, only local key valid.	0~3	0

Function	Name	Description	Setting	Default
		3: Both display and key valid.		
P7.06	Running status display selection 1	0~0XFFFF BIT0: running frequency BIT1: reference frequency BIT2: DC bus voltage BIT3: Output voltage BIT4: Output current BIT5: Rotation speed BIT6: Line speed BIT7: Output power BIT8: Output torque BIT9: PID preset BIT10: PID feedback BIT11: Input terminal status BIT12: Output terminal status BIT13: Torque setting value BIT14: Count value	0~0XFFFF	0X07FF
P7.07	Running status display selection 2	0~0XFFFF BIT0: AI1 BIT1: AI2 BIT2: HDI frequency BIT3: Load percentage of motor BIT4: Load percentage of inverter BIT5~15: Reserved	0~0XFFFF	0

Function	Name	Description	Setting	Default
P7.08	Stop status display selection	0~0XFFFFFF BIT0: Reference frequency BIT1: DC bus voltage BIT2: Input terminal status BIT3: Output terminal status BIT4: PID preset BIT5: PID feedback BIT6: AI1 BIT7: AI2 BIT8: HDI frequency BIT9: Step No.of PLC or multi-step BIT10: Torque setting value BIT11~ BIT15: Reserved	0~0XFFFF	0x00ff
P7.09	Coefficient of rotation speed	0.0~999.9% Actual mechanical speed = $120 * \text{output frequency} * \text{P7.09} / \text{Number of poles of motor}$	0.1~999.9	100.00%
P7.10	Coefficient of line speed	0.0~999.9% Line speed = actual mechanical speed * P7.10	0.1~999.9	1.00%
P7.11	Rectify module temperature	0~100.0		
P7.12	IGBT module temperature	0~100.0		

Function	Name	Description	Setting	Default
P7.13	Software version			
P7.14	Inverter rated power	0.4~3000.0KW	0.4~3000.0	Depend on model
P7.15	Inverter rated current	0.0~6000.0A	0.0~6000.0	Depend on model
P7.16	Accumulated running time	0~65535h		
P7.17	Third latest fault type	0: Not fault 1: IGBT Ph-U fault(OUT1)		
P7.18	Second latest fault type	2: IGBT Ph-V fault(OUT1) 3: IGBT Ph-W fault(OUT1) 4: Over-current when acceleration(OC1)		
P7.19	Latest fault type	5: Over-current when deceleration(OC2) 6: Over-current when constant speed running(OC3) 7: Over-current when acceleration (OV1) 8: Over-current when deceleration (OV2) 9: Over-current when constant speed running(OV3) 10: DC bus under-voltage(UV) 11: Motor overload (OL1) 12: Inverter overload (OL2)		

Function	Name	Description	Setting	Default
		13: Input phase failure failure(SPO) 14: Output phase failure(SPO) 15: Rectify overheat (OH1) 16: IGBT overheat (OH2) 17: External fault (EF) 18: Communication fault(CE) 19: Current detection fault(ITE) 20: Autotuning fault (TE) 21: EEPROM fault (EEP) 22: PID feedback fault (PIDE) 23: Braking unit fault (BCE) 24: Running time arrival (END) 25: Overtorque fault ( OL3)		
P7.20	Output frequency at current fault			
P7.21	Output current at current fault			
P7.22	DC bus voltage at current fault			
P7.23	Input terminal status at current fault			
P7.24	Output terminal status at current fault			



<b>P8 Group: Enhanced Function</b>				
Function	Name	Description	Setting	Default
P8.00	Acceleration time 1	0.1~3600.0s	0.1~3600.0	Depend on model
P8.01	Deceleration time 1	0.1~3600.0s	0.1~3600.0	Depend on model
P8.02	Acceleration time 2	0.1~3600.0s	0.1~3600.0	Depend on model
P8.03	Deceleration time 2	0.1~3600.0s	0.1~3600.0	Depend on model
P8.04	Acceleration time 3	0.1~3600.0s	0.1~3600.0	Depend on model
P8.05	Deceleration time 3	0.1~3600.0s	0.1~3600.0	Depend on model
P8.06	Jog reference	0.0~P0.03	0.00~P0.03	5.00Hz
P8.07	Jog acceleration time	0.1~3600.0s	0.1~3600.0	Depend on model
P8.08	Jog deceleration time	0.1~3600.0s	0.00~P0.03	Depend on model
P8.09	Skip Frequency1	0.00~P0.03	0.00~P0.03	0.00Hz
P8.10	Skip Frequency2	0.00~P0.03	0.00~P0.03	0.00Hz
P8.11	Skip Frequency bandwidth	0.00~P0.03	0.00~P0.03	0.00Hz
P8.12	Traverse amplitude	0.0~100.0%	0.0~100.0	0.00%

Function	Name	Description	Setting	Default
P8.13	Jitter frequency	0.0~50.0%	0.0~50.0	1.00%
P8.14	Rise time of traverse	0.1~3600.0s	0.1~3600.0	5.0s
P8.15	Fall time of traverse	0.1~3600.0s	0.1~3600.0	5.0s
P8.16	Auto reset times	0~3	0~3	0
P8.17	Reset interval	0.1~100.0s	0.1~100.0	1.0s
P8.18	Preset count value	P8.19~65535	P8.19~655	0
P8.19	Specified count value	0~P8.18	0~P8.18	0
P8.20	Preset running time	0~65535	0~65535	65535h
P8.21	FDT level	0.00~P0.03	0.00~P0.03	50.00Hz
P8.22	FDT lag	0.0~100.0%	0.0~100.0	5.00%
P8.23	Frequency arrive detecting range	0.0~100.0% (maximum frequency)	0.0~100.0	0.00%
P8.24	Droop control	0.00~10.00Hz	0.00~10.00	0.00Hz
P8.25	Brake threshold voltage	115.0~140.0%	115.0~140	130.00%
P8.26	Cooling fan control	0: Auto stop mode 1: Always working	115.0~140	120.00%

Function	Name	Description	Setting	Default
P8.27	Overmodulation	0: Enabled 1: Disabled	0~1	0
P8.28	PWM mode	0: PWM mode 1 1: PWM mode 2 2: PWM mode 3	0~1	0
<b>P9 Group: PID Control</b>				
P9.00	PID preset source selection	0: Keypad 1: AI1 2: AI2 3: HDI 4: Multi-step 5: Remote communication	0~5	0
P9.01	Keypad PID preset	0.0%~100.0%	0.0~100.0	0.00%
P9.02	PID feedback source selection	0: AI1 1: AI2 2: AI1+AI2 3: HDI 4: Communication	0~3	0
P9.03	PID output characteristic	0: Positive 1: Negative	0~1	0
P9.04	Proportional gain (KP)	0.00~100.00	0.00~100.0	0.10s
P9.05	Integral time (Ti)	0.00~10.00s	0.01~10.00	0.10s
P9.06	Differential time (Td)	0.00~10.00s	0.00~100.0	0.01s

Function	Name	Description	Setting	Default
P9.07	Sampling cycle (T)	0.01~100.00s	0.00~100.0	0.00%
P9.08	Bias limit	0.0~100.0%	0.0~100.0	0.00%
P9.09	Feedback lost detecting value	0.0~100.0%	0.0~100.0 %	0.00%
P9.10	Feedback lost detecting time	0.0~3600.0s	0.0~3600.0	1.0s

**PA Group: Simple PLC and Multi-step Speed Control**

PA.00	Simple PLC	0: Stop after one cycle 1: Hold last frequency after one cycle 2: Circular run	0~2	0
PA.01	Simple PLC status saving after power off	0: Disabled 1: Enabled	0~1	0
PA.02	Multi-step speed 0	-100.0~100.0%	-100.0~100	0.00%
PA.03	0 <sup>th</sup> Step running time	0.0~6553.5s(h)	0.0~6553.5	0.0s
PA.04	Multi-step speed 1	-100.0~100.0%	-100.0~100	0.00%
PA.05	1st Step running time	0.0~6553.5s(h)	0.0~6553.5	0.0s

Function	Name	Description	Setting	Default
PA.06	Multi-step speed2	-100.0~100.0%	-100.0~100	0.00%
PA.07	2 <sup>nd</sup> step running time	0.0~6553.5s(h)	0.0~6553.5	0.0s
PA.08	Multi-step speed 3	-100.0~100.0%	-100.0~100	0.00%
PA.09	3 <sup>rd</sup> step running time	0.0~6553.5s(h)	0.0~6553.5	0.0s
PA.10	Multi-step speed 4	-100.0~100.0%	-100.0~100	0.00%
PA.11	4 <sup>th</sup> Step running time	0.0~6553.5s(h)	0.0~6553.5	0.0s
PA.12	Multi-step speed 5	-100.0~100.0%	-100.0~100	0.00%
PA.13	5 <sup>th</sup> Step running time speed	0.0~6553.5s(h)	0.0~6553.5	0.0s
PA.14	Multi-step	-100.0~100.0%	-100.0~100	0.00%
PA.15	6 <sup>th</sup> Step running time	0.0~6553.5s(h)	0.0~6553.5	0.0s
PA.16	Multi-step speed 7	-100.0~100.0%	-100.0~100	0.00%
PA.17	7 <sup>th</sup> Step running time	0.0~6553.5s(h)	0.0~6553.5	0.0s
PA.18	Multi-step speed 8	-100.0~100.0%	-100.0~100	0.00%
PA.19	8 <sup>th</sup> Step running time	0.0~6553.5s(h)	0.0~6553.5	0.0s

Function	Name	Description	Setting	Default
PA.20	Multi-step speed 9	-100.0~100.0%	-100.0~100	0.00%
PA.21	9 <sup>th</sup> Step running time	0.0~6553.5s(h)	0.0~6553.5	0.0s
PA.22	Multi-step speed 10	-100.0~100.0%	-100.0~100	0.00%
PA.23	10 <sup>th</sup> Step running time	0.0~6553.5s(h)	0.0~6553.5	0.0s
PA.24	Multi-step speed 11	-100.0~100.0%	-100.0~100	0.00%
PA.25	11 <sup>th</sup> Step running time	0.0~6553.5s(h)	0.0~6553.5	0.0s
PA.26	Multi-step speed 12	-100.0~100.0%	-100.0~100	0.00%
PA.27	12 <sup>th</sup> Step running time	0.0~6553.5s(h)	0.0~6553.5	0.0s
PA.28	Multi-step speed 13	-100.0~100.0%	-100.0~100	0.00%
PA.29	13 <sup>th</sup> Step running time	0.0~6553.5s(h)	0.0~6553.5	0.0s
PA.30	Multi-step speed 14	-100.0~100.0%	-100.0~100	0.00%
PA.31	14 <sup>th</sup> Step running time	0.0~6553.5s(h)	0.0~6553.5	0.0s
PA.32	Multi-step speed 15	-100.0~100.0%	-100.0~100	0.00%

Function	Name	Description	Setting	Default
PA.33	15 <sup>th</sup> Step running time	0.0~6553.5s(h)	0.0~6553.5	0.0s
PA.34	ACC/DEC time selection for step 0~7	0~0XFFFF	0~0XFFFF	0
PA.35	ACC/DEC time selection for step 8~15	0~0XFFFF	0~0XFFFF	0
PA.36	Simple PLC restart selection	0: restart from step 0 1: Continue from paused step	0~1	0
PA.37	Time unit	0: Second 1: Minute	0~1	0
<b>PB Group: Protection Function</b>				
Pb.00	Input phase-failure protection	0: Disabled 1: Enabled	0~1	1
Pb.01	Output phase-failure protection	0: Disabled 1: Enabled	0~1	1
Pb.02	Motor overload protection	0: Disabled 1: Normal motor(with low speed compensation) 2: Variable frequency motor (without low speed compensation)	0~2	2

Function	Name	Description	Setting	Default
Pb.03	Motor overload protection current	20.0%~120.0% (rated current of the motor)	20.0~120.0	100.00%
Pb.04	Threshold of trip-free	70.0.0~110.0% (standard bus voltage)	70.0~110.0	80.00%
Pb.05	Decrease rate of trip-free	0.00~P0.03 (the Max. frequency)	0.00~P0.03	0.00Hz/s
Pb.06	Over-voltage stall	0: Disabled 1: Enabled	0~1	1
Pb.07	Over-voltage stall protection point	110~150%	110~150	120%
Pb.08	Auto current limiting threshold	50~200%	50~200	G model : 150.00% P model : 160.00%
Pb.09	Frequency decrease rate when current limiting	0.00~100.00Hz/s	0.00~100.0	10.00Hz/s
Pb.10	Auto current limiting selection	0: Enabled 1: Disabled when constant speed	0~1	0



Function	Name	Description	Setting	Default
Pb.11	Selection of overtorque (OL3)	0: No detection 1: Valid detection of overtorque during running, then continue running 2: Valid detection of overtorque during running, then warning and stop 3: Valid detection of overtorque during constant speed running, then continue running 4: Valid detection of overtorque during constant speed running, then warning and stop.	0~4	1
Pb.12	Detection level of overtorque	10.0%~200.0%(relative to the rated current of the motor)	1.0~200.0	G model :150.0% P model :120%
Pb.13	Detection time of overtorque	0.1~60.0s	0.0~60.0	0.1s
Pb.14	reserved			
Pb.15	reserved			
<b>PC Group: serial communication</b>				
PC.00	Local address	0~247, 0 stands for the broadcast address	0~247	1

Function	Name	Description	Setting	Default
PC.01	Baud rate selection	0: 1200BPS 1: 2400BPS 2: 4800BPS 3: 9600BPS 4: 19200BPS 5: 38400BPS	0~5	4
PC.02	Data format	0: RTU, 1 start bit, 8 data bits, no parity check, 1 stop bit. 1: RTU, 1 start bit, 8 data bits, even parity check, 1 stop bit. 2: RTU, 1 start bit, 8 data bits, odd parity check, 1 stop bit. 3: RTU, 1 start bit, 8 data bits, no parity check, 2 stop bit. 4: RTU, 1 start bit, 8 data bits, even parity check, 2 stop bit. 5: RTU, 1 start bit, 8 data bits, odd parity check, 2 stop bit.	0~5	1
PC.03	Communication delay time	0~200ms	0~200	5ms
PC.04	Communication timeout delay	0.0: Disabled 0.0~100.0s	0.0~100.0	0.0s
PC.05	Communication error action	0: Alarm and coast to stop 1: No alarm and continue to run 2: No alarm but stop	0~3	1

Function	Name	Description	Setting	Default
		according to P1.06(if P0.03=2) 3: No alarm but stop according to P1.06		
PC.06	Response action	Unit's place of LED 0: Response to writing 1: No response to writing Ten's place of LED 0: Reference not saved when power off 1: Reference saved when power off	00~11	0
<b>Pd Group: Supplementary Function</b>				
<b>PE Group: Factory Setting</b>				

## 8-TROUBLE SHOOTING

fault messages including the possible cause and corrective actions. This

chapter tells how to reset faults and view fault history. It also lists all alarm and

### 8.1 Fault and Trouble shooting

Fault Code	Fault Type	Reason	Solution
Out1	IGBT fault	<ol style="list-style-type: none"> <li>1. Acc time is too short.</li> <li>2. IGBT module fault.</li> <li>3. Malfunction caused by interference.</li> <li>4. Grounding is not properly</li> </ol>	<ol style="list-style-type: none"> <li>1. Increase Acc time.</li> <li>2. Ask for support.</li> <li>3. Inspect external equipment and eliminate interference.</li> </ol>
OC1	Over-current when acceleration	<ol style="list-style-type: none"> <li>1. Acc time is too short.</li> <li>2. The voltage of the grid is too low.</li> <li>3. The power of the inverter is too low.</li> </ol>	<ol style="list-style-type: none"> <li>1. Increase Acc time.</li> <li>2. Check the input power</li> <li>3. Select bigger capacity inverter.</li> </ol>
OC2	Over-current when deceleration	<ol style="list-style-type: none"> <li>1. Dec time is too short.</li> <li>2. The torque of the load inertia is big</li> <li>3. The power of the inverter is too low.</li> </ol>	<ol style="list-style-type: none"> <li>1. Increase Dec time.</li> <li>2. Install a proper energy consumption braking components</li> <li>3. Select bigger capacity inverter.</li> </ol>
OC3	Over-current when constant speed running	<ol style="list-style-type: none"> <li>1 The load transients or is abnormal.</li> <li>2. The voltage of the grid is too low.</li> <li>3. The power of the inverter is</li> </ol>	<ol style="list-style-type: none"> <li>1. Check the load or reduce the transient of the load</li> <li>2. Check the input power supply</li> <li>3. Select bigger capacity inverter.</li> </ol>
OV1	Over-voltage when	<ol style="list-style-type: none"> <li>1. The input voltage is Abnormal</li> </ol>	<ol style="list-style-type: none"> <li>1. Check the input power</li> </ol>

Fault Code	Fault Type	Reason	Solution
	acceleration	2. Restart the running motor after sudden power loss.	2.Avoid restart-up after stopping
OV2	Over-voltage when deceleration	1. Dec time is too short. 2.The inertia of the load is big. 3.The input voltage is abnormal	1.Increase the Dec time 2.Increase the energy-consuming components 3. Check the input power
OV3	Over-voltage when constant speed running	1. The input voltage changes Abnormally. 2. The inertia of the load is big.	1. Install the input reactor 2.Add proper energy-consuming components
UV	DC bus Under-voltage	1. The voltage of the grid is low	1.Check the input power supply of the grid
OL1	Motor overload	1. The voltage of the power supply is 2. The motor setting rated current is incorrect. 3. The motor stall or load transients is too strong. 4.The power of the motor is too big.	1. Check the power of the supply Line 2. Reset the rated current of the motor 3. Check the load and adjust the torque lift 4. Select a proper motor.
OL2	Inverter overload	1. The acceleration is too fast 2. Reset the rotating motor 3. The voltage of the power supply is too low. 4. The load is too heavy.	1. Increase the ACC time 2. Avoid the restarting after stopping. 3. Check the power of the supply line 4. Select an inverter with bigger power

Fault Code	Fault Type	Reason	Solution
SPI	Input phase loss	Phase loss or fluctuation of input R,S,T	1. Check input power 2. Check installation distribution
SPO	Output phase loss	U , V , W phase loss input(or serious asymmetrical three phase of the load)	1. Check the output distribution 2. Check the motor and cable
OH1	Rectify IGBT overheat	1.Sudden overcurrent of the inverter 2.There is direct or indirect short circuit between output 3 phase 3.Air duct jam or fan damage 4.Ambient temperature is too high.	1. Refer to the overcurrent solution 2. Redistribute 3. Dredge the wind channel or 4. Low the ambient temperature
OH2	Inverter IGBT overheat	5.The wiring of the control panel or plug-ins are loose 6.The assistant power supply is damaged and the drive voltage is undervoltage 7.The bridge arm of the power module is switched on 8.The control panel is abnormal	5. Check and reconnect 6. Ask for service 7. Ask for service 8. Ask for service
EF	External fault	S1: External fault input terminal take effect	1. Check the external device input

Fault Code	Fault Type	Reason	Solution
CE	Communication	1. The baud rate setting is incorrect. 2. Communication fault	1. Set proper baud rate 2. Press STOP/RST to reset and ask for help 3. Check the communication
		3. The communication is off for a long time.	connection distribution
ItE	Current detection fault	1. The connection of the control board is not good Assistant power is bad 2. Assistant power is damaged 3. Hoare components is broken 4. The modifying circuit is abnormal.	1. Check and reconnect 2. Ask for service 3. Ask for service 4. Ask for service
tE	Autotuning fault	1. The motor capacity does not comply with the inverter capability 2. The rated parameter of the motor	1. Change the inverter model 2. Set the rating parameters according to the nameplate of the motor
EEP	EEPROM fault	1. Error of controlling the write and read of the parameters 2. Damage to EEPROM	1. Press STOP/RST to reset 2. Ask for service
PIDE	PID feedback fault	1. PID feedback offline 2. PID feedback source disappear	1. Check the PID feedback signal wires 2. Check PID feedback source

Fault Code	Fault Type	Reason	Solution
bE	Braking unit fault	<ol style="list-style-type: none"> <li>1. Braking circuit fault or damage to the braking pipes</li> <li>2. The external braking resistor is a little low</li> </ol>	<ol style="list-style-type: none"> <li>1. Check the braking unit and change new braking pipes</li> <li>2. Increase the braking resistor</li> </ol>
END	Time reach of factory setting	<ol style="list-style-type: none"> <li>1. Trial time arrival</li> </ol>	<ol style="list-style-type: none"> <li>1. Ask for service</li> </ol>
OL3	Overtorque	<ol style="list-style-type: none"> <li>1. The acceleration is too fast</li> <li>2. Reset the rotating motor</li> <li>3. The voltage of the power supply is too low.</li> <li>4. The load is too heavy.</li> </ol>	<ol style="list-style-type: none"> <li>1. Increase the ACC time</li> <li>2. Avoid the restarting after stopping.</li> <li>3. Check the power of the supply line</li> <li>4. Select an inverter with bigger power</li> <li>5. Adjust PB.11 to a proper value</li> </ol>



## 自序

该MA510产品是设计用于控制三相异步电机的变频器.请仔细阅读本手册，以确保正确的操作，安全和熟悉的逆变器的功能。

在MA510逆变器是一种电气/电子产品，必须安装合格的维修人员来处理。

处理不当，可能会导致不正确的操作，生命周期较短，或者失败这种产品，以及电机。

所有MA510文件如有变更，恕不另行通知.请务必获取最新版本使用或访问我们的网站 [www.tetaelectric.com](http://www.tetaelectric.com)



可用文档：



1. MA510启动和安装手册
2. MA510说明书

阅读本说明书在进行安装，配线（连接），运行，维修和检查前彻底。

确保您有变频器的良好的知识，并着手操作变频器之前，所有的安全注意事项，熟悉。

请密切关注由指定的安全注意事项

警告  和慎重  符号

 <b>警示</b>	未能无视警告标志指示的信息可能会造成死亡或严重伤害。
 <b>慎重</b>	未能无视警示符号表示的信息可能会造成轻微的人身伤害和/或重大财产损失。

## 第1章安全注意事项

### 1.1 在供电的逆变器



#### 警示

主电路必须正确接线.对于单相供电使用的输入端子 ( R / L1 , T / L3 ) 和三相电源使用输入端子 ( R / L1 , S / L2 , T / L3 ) .端子U/ T1 , V / T 2 , W / T3必须仅用于连接电机.连接的输入电源任何U/ T1的 , V / T2或W / T3终端将导致损坏逆变器。



#### 慎重

为了避免脱离或其他物理损坏前盖 , 不要被它的封面进行逆变器.其散热器运输时支持单位.操作不当可能会损坏变频器或伤害的人员 , 并应尽量避免。

□ 为避免火灾的危险 , 不要打开或易燃物品附近安装变频器.安装在不可燃物 , 如金属表面。

□ 若多台变频器放在同一个控制面板内 , 提供足够的通风 , 以保持低于40°C /104°F 温度 ( 50°C/122°F无防尘罩 ) , 以避免过热或起火。

□ 当拆卸或安装数字操作 , 关闭电源 , 然后再按照本手册中的说明 , 以避免操作错误或损失显示器造成的接触不良。



#### 警示

□ 本产品系通过IEC618003.在家庭环境中 , 该产品可能会造成这种情况下 , 用户可能需要采取纠正措施的无线电干扰。

□ 过的电机温度保护功能关闭。

## 1.2 接线



### 警示

- 务必关掉电源是否逆变器安装在用户终端和接线之前。
- 接线都必须由合格的人员/认证的电工进行。
- 确保变频器正确接地。  
( 200V级：接地阻抗应小于100Ω400V级：接地阻抗应大于10Ω少 )。它需要断开接地线在控制板上，以避免突然增加造成的电子零件损坏，如果它是不正确接地。
- 请检查和接线后，测试紧急停止电路。( 安装程序负责正确接线。 )
- 切勿触摸任何输入或输出电源线直接或允许任何输入或输出电源线来与逆变器壳体接触。
- 不要执行一电介质耐压逆变器上测试( 兆欧表 )或这将导致逆变器损坏半导体元件。



### 慎重

- 应用必须遵守变频器的额定输入电压的线电压。
- 制动电阻和制动单元连接到指定的终端。
- 不要直接连接制动电阻，直流端子P( + )和N( - )，否则可能会导致起火。
- 使用线规建议和扭矩规格。
- 切勿输入电源连接到变频器输出端子U/ T1，V/ T2，W / T3。
- 不要连接接触器或开关串联逆变器和电机。
- 不要将功率因数校正电容或浪涌抑制器到变频器的输出。
- 确保由逆变器和电动机产生的干扰不会影响外围设备。

### 1.3 术前



#### 警示

降低载波频率（参数P0-14）。如果从逆变器到电动机的电缆是超过80英尺（25米）。高频电流可以通过寄生生成在过流的逆变器的跳闸电缆和结果之间的电容，一个，或不准确的电流读数。

务必打开电源之前安装好所有的盖子。不要删除任何的封面，而电源逆变器上，否则可能会发生触电。

不要操作开关用湿手，否则可能会造成触电。

通电时，即使变频器已经停止不要触摸变频器端子，否则会导致触电。

### 1.4 参数设置



#### 慎重

不要负载连接到电机，同时进行自动调整。

确保电机能自由运转和有电机周围执行旋转自动调谐时有足够的空间。

## 1.5 操作



### 警示

- 不要连接或操作过程中断开电机。这将导致逆变器跳闸并可能损坏逆变器。
- 操作可能会突然启动，如果报警或故障复位与运行命令有效。确认没有运行命令后，重置报警或故障激活，否则可能发生事故。
- 如果恢复供电（参数P1-14）后自动重启启用时，逆变器将自动供电恢复后启动。
- 确保它是安全的执行旋转自动调谐之前，操作变频器和电机。
- 请勿检查信号电路板上的变频器运行时。
- 之后关闭电源，冷却风扇可以继续运转一段时间。



### 慎重

- 不要触摸发热部件如散热器和制动电阻。
- 在高速运转之前  仔细检查电动机或机器的性能，否则可能造成伤害。
- 注意有关制动单元时适用的参数设置。
  - 不要使用变频器的制动功能的机械保持，否则可能会造成伤害。
  - 请勿检查信号电路板上的变频器运行时。

## 1.6 维护，检查和更换



### 警示

至少等待5分钟后电源已关闭在开始检查前。同时确认充电指示灯熄灭，并且直流母线电压低于25VDC等待至少15分钟，而逆变器是在20HP。

切勿触摸变频器的高压端子。

确保电源逆变器拆卸逆变器之前断开。

只有授权人员才能进行维修，检查和更换操作。

( 取下金属饰品如手表和戒指，并使用绝缘工具。 )



### 慎重

该逆变器可以与一个温度范围内的环境从14°-104°F(-10 ~ 40°C) 和95% 的非 冷凝的相对湿度被使用。

变频器必须在一个灰尘，气体，气雾和无湿气的环境中操作。

## 1.7 处置逆变器



### 慎重

请小心处理本单位作为工业废弃物，并根据您的需要的地方法规。

逆变主电路和印刷电路板的电容器被认为是有害废物，必须不被烧坏。

变频器的塑料外壳和部件，如顶盖板会如果 焚 烧释放出有害气体。

## 第2章型号说明

### 2.1 铭牌数据

关键是要验证MA510变频器的铭牌，并确保在MA510逆变器有正确的评价，

因此它可以与适当大小的交流电机应用中使用。

拆开MA510逆变器和检查以下内容：

- (1) MA510逆变器和速凝导向都包含在包中。
- (2) MA510逆变器尚未在运输过程中损坏，应无凹陷或零件丢失。
- (3) MA510逆变器是您点的类型。您可以检查主铭牌上的型号和规格。
- (4) 检查输入电压范围满足输入功率要求。
- (5) 确保电机惠普与变频器的电机功率。

### 型号识别

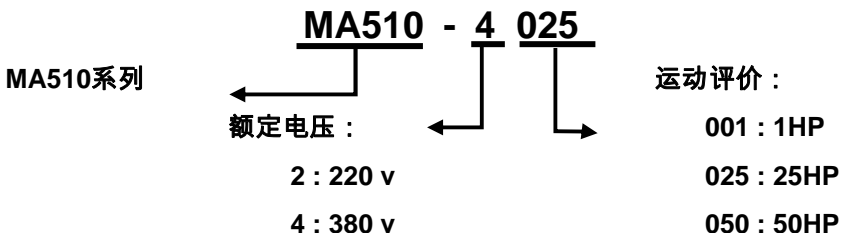
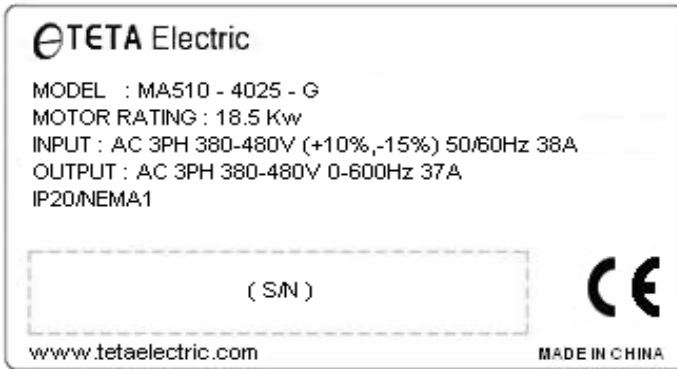

## 2.2 变频器型号，电机额定功率

型号	输入电压	额定功率 (kw)	额定输入电流(A)	额定输出电流 (A)	额定输出电流 (HP)
MA510-2001	3-相 220V - + 15%	0.75	5	4.5	1
MA510-2002		1.5	7.7	7	2
MA510-2003		2.2	11	10	3
MA510-2005		4	17	16	5
MA510-2008		5.5	21	20	7.5
MA510-2010		7.5	31	30	10
MA510-2015		11	43	42	15
MA510-2020		15	56	55	20
MA510-2025		18.5	71	70	25
MA510-2030		22	81	80	30
MA510-2040		30	112	110	40
MA510-2050		37	132	130	50
MA510-2060		45	163	160	60
MA510-2075		55	181	190	75
MA510-4001		3-相 380V - + 15%	0.75	3.4	2.5
MA510-4002	1.5		5	3.7	2
MA510-4003	2.2		5.8	5	3
MA510-4005	4		10	9	5
MA510-4008	5.5		15	13	7.5
MA510-4010	7.5		20	17	10
MA510-4015	11		26	25	15
MA510-4020	15		35	32	20
MA510-4025	18.5		38	37	25
MA510-4030	22		46	45	30



型号	输入电压	额定功率 (kw)	额定输入电流(A)	额定输出电流 (A)	额定输出电流 (HP)
MA510-4040	3-phase 380V -+ 15%	30	62	60	40
MA510-4050		37	76	75	50
MA510-4060		45	90	90	60
MA510-4075		55	105	110	75
MA510-4100		75	140	150	100
MA510-4125		90	160	176	125
MA510-4150		110	210	210	150
MA510-4175		132	240	250	175
MA510-4215		160	290	300	215
MA510-4250		185	330	340	250

### 第3章环境及安装

#### 3.1 环境

变频器的安装环境直接影响其功能和使用寿命。因此，安装环境必须满足以下

条件：

适用环境	
工作温度	( 10~40°C ) ( 具有防尘保护盖打开，适用的工作温度 ( 10~50°C ) ( 满载 ) 可以达到最大60°C )。但它需要降额额定电流的2%用于增加一度。 对于多台变频器并排安装在板上，请注意位置，以方便散热。
储存温度	(-20~70C)
湿度	相对湿度为5%至95%，游离的缩合或水滴。
冲击	最大加速度：1.2G ( 12米/ S <sup>2</sup> )，从49.84到150赫兹 位移振幅：0.3毫米 ( 峰值 )，由10~49.84赫兹

## 3.2 设备

### 安装地点

该产品应安装在便于操作的环境，避免被暴露在以下环境中

- 避免阳光直射
- 避免雨滴或潮湿的环境中
- 避免油雾，盐的侵蚀
- 避免腐蚀性液体和气体
- 避免灰尘，绒毛纤维及金属细屑。
- 防止电磁干扰（熔接机，动力机器）
- 远离放射性物质及可燃物
- 避免震动（冲床）。请添加防振垫，以减少振动，如果它不能避免

### 3.2.1 安装空间

请安装MA510变频器在垂直方向上，留出足够的空间，保证散热效果，如下

图所示。避免上下颠倒或水平安装。

变频器散热器冷却的温度可能达到90°C运行。

因此，接触表面为变频器安装由高温性材料制成。

当变频器在电力配电箱操作，环境一定要通风，环境温度必须小于+ 40°C。

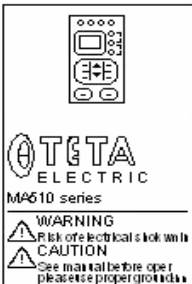

向上/向下	请留下150mm
左右侧	为18.5KW的逆变器容量（包括较小千瓦），推荐的最小宽度为100mm。
	为22千瓦（包括较高千瓦）逆变器的容量，建议的最小宽度为200mm。

### 3.2.2外形图和零件描述

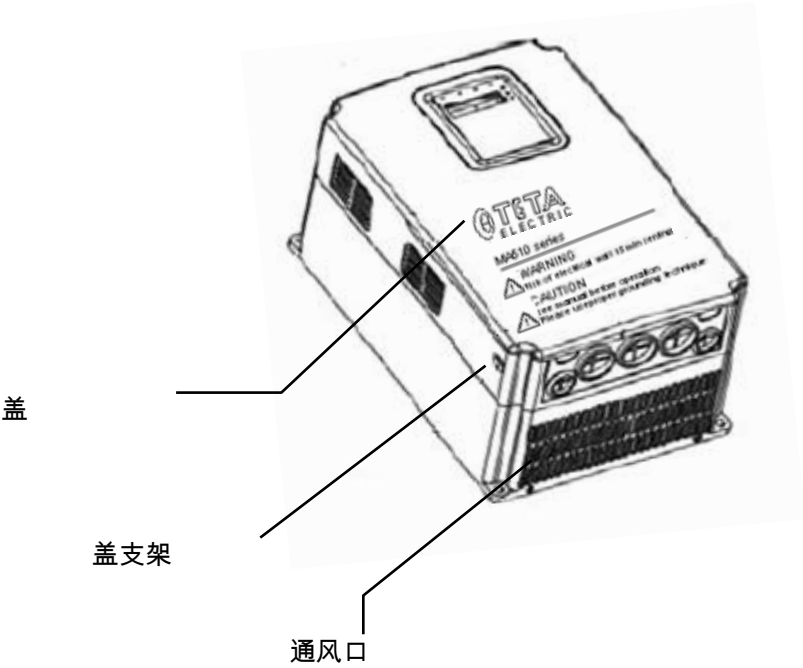

对于低于25惠普能力

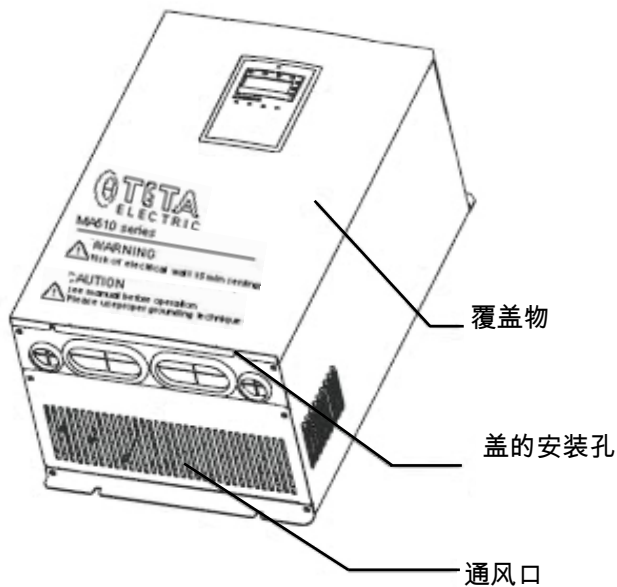
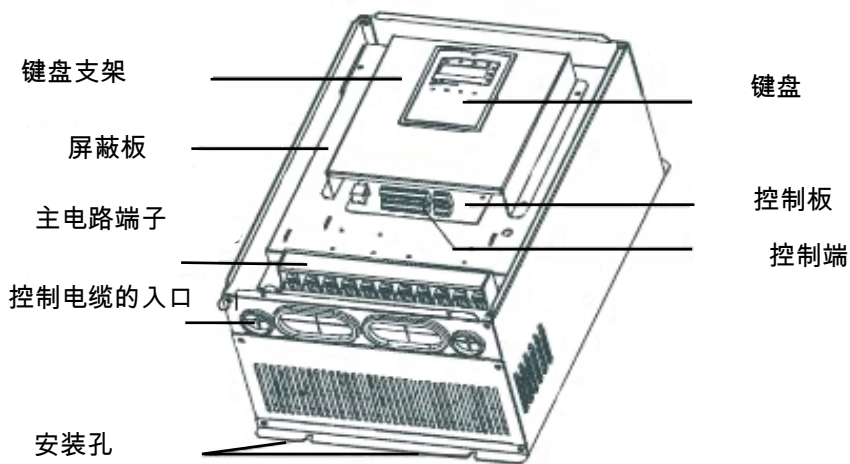

对于上面的能力 (包括) 25 HP

### 3.2.2 外形图和零件描述



**慎重**

不要安装或使用被损坏或故障配件的任何逆变器，否则可能发生人身伤害。

拆包逆变器后检查下列项目

- 1.检查变频器与电机的整个外，以确保没有划伤或损坏所造成的交通
- 2.确保有操作手册中的包装盒
- 3.检查铭牌，并确保它是您点什么。
- 4.确保可选的部分是你所需要的，如果你已经订购的。

请联系当地的代理商，如果有到逆变器或可选部件的损坏。

### 3.2.4 拆卸与安装



**慎重**

的主要部分的下落可能会造成人身伤害。

逆变器被固定在一个不易燃的壁，例如金属和远离热源和易燃材料，以避免火灾。

如果两个以上的驱动器安装在机柜，其温度应通过冷却风扇的装置是低于40。过热可能导致火灾或损坏驱动器。



## 警示

只有合格的人才被允许驱动设备/系统上运行。忽略中的说明”，“警告”，“可能会导致严重的人身伤害或死亡或财产损失。1，电源被切断后，而”充电“指示灯逆变器仍在，这意味着电容尚未完成的排出。请勿触摸电路或在这个时候更换部件。

2.切勿线或拆卸/安装变频器内部连接器时，接通电源。

3.禁止连接的逆变器输出端子与交流电源的U，V和W。

变频器4.终端E必须良好接地。

5.由于半导体元件是由高压易损坏，不进行高耐压试验在MA510变频器内部元器件。

6.变频器控制板的 CMOS IC很容易受到影响，并通过静态破坏电力，因此，不要触摸控制板。

7.连接输入电源线连接紧固，久治不愈。

### 3.3 变频器的布线

#### 3.3.1 接线外围功率器件

配线MA510的周边装置的实例示于以下：



### 3.3.2 一般接线图

以下是可能不同的标准接线图MA510 .地点和接线端子排的象征，由于不同的模式。

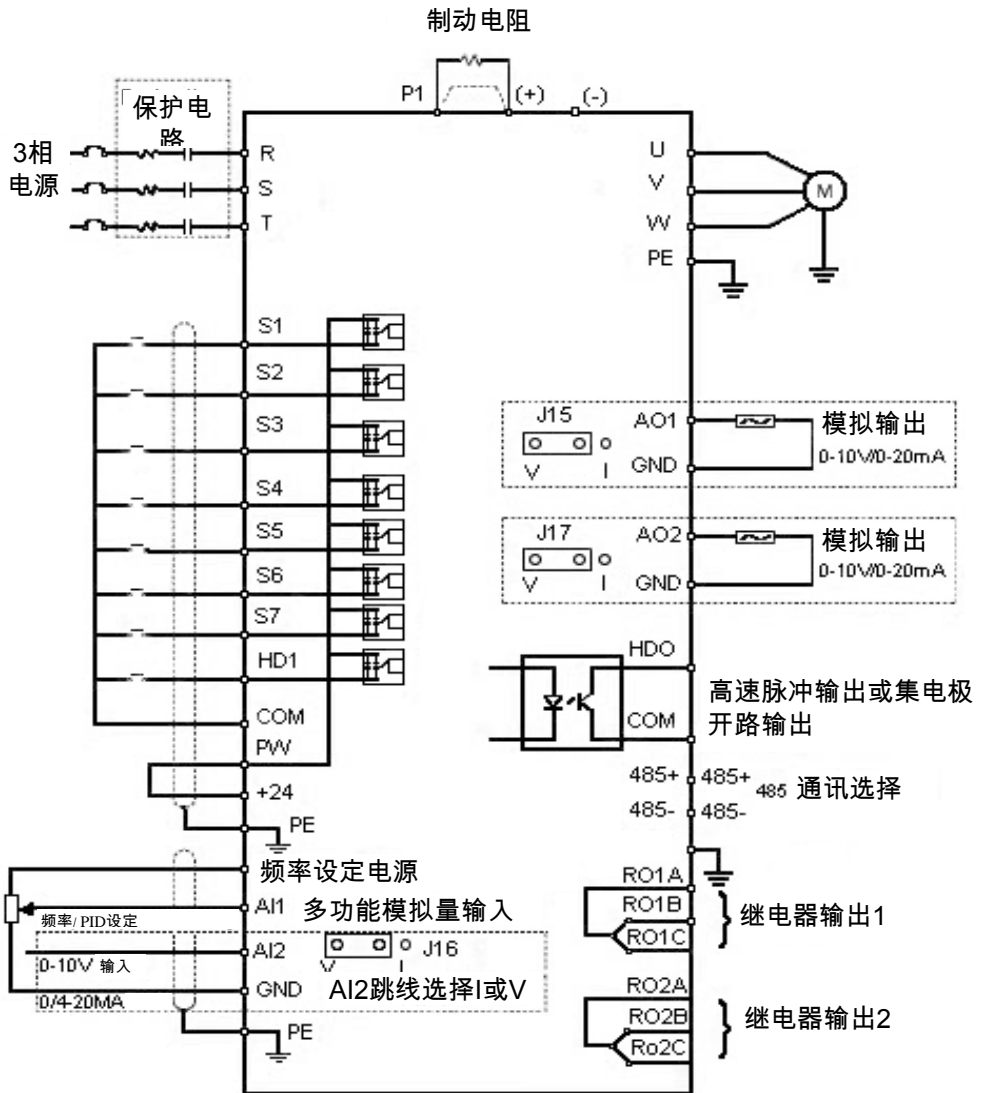

对于逆变器  $\geq 18.5$  千瓦



的380伏1只有主电路~20HP (含)或更低的容量与内置制动电阻器模型提供

终端PB.The制动电阻可以直接在(+)和PB连接。

制动电阻器的导线长度应小于5米。

安装制动电阻时，请注意的Safty预防和流畅的通风，因为温度升高的散热。

的(+)和(-)的制动单元端子对应于(+)和(-)时的外部制动单元被连接在逆变器的端子。

之间的布线长度的(+)和(-)的inerters的和终端的(+)，(-)的制动单元应该不超过5m和间BR1和BR2的分布长度和制动电阻器端子不应该要大于10m。



**慎重**

确保的(+)电动极性(-)端子是正确的;它不允许连接(+)与(-)直接端子，否则会损坏或可能发生火灾

### 3.3.3 端子说明

#### 主要回路端子

Terminal	function discription
R S T	三相交流输入端子
(+) (-)	外置制动单元的备用端子
(+) PB	外接制动电阻的备用端子
P1 (+)	外部直流电抗器的备用端子
(-)	负直流母线端子
(+)	正直流母线端子
U V W	三相交流输出端子
	的接地端子

2 ~ 3 HP , 380 V

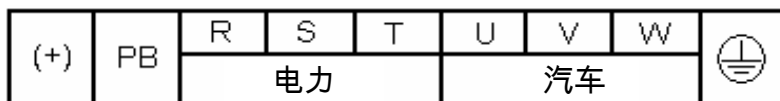

5 ~ 7.5 HP , 220 / 380 V

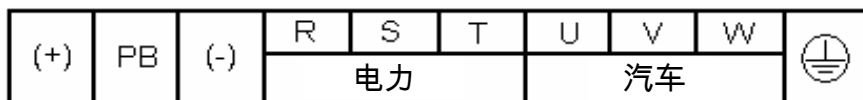

10 ~ 20 HP , 380 V / 10HP 220 V



25 ~ 150 HP , 380 V / 15 ~ 20 HP 220V

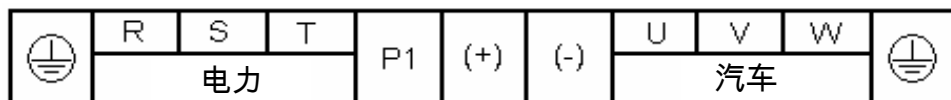

175 ~ 250 HP , 380 V

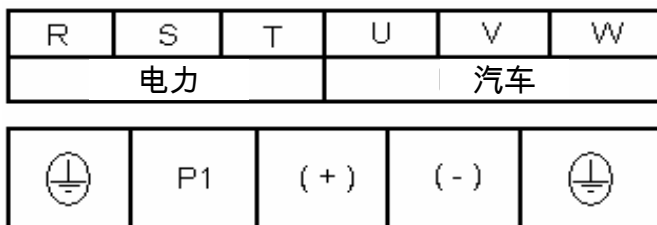

控制回路端子

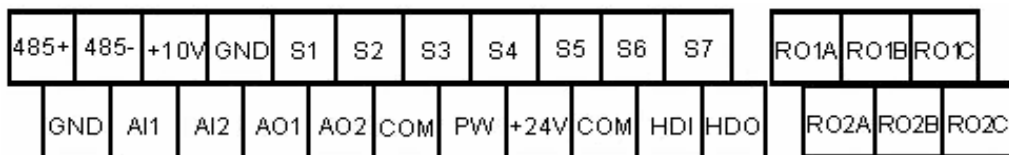

类型	终端站	终端功能	信号电平
数字输入	S1~S7	ON-OFF 信号输入，与PW和光耦合的COM	24VDC，8mA 光电耦合器 隔离 ( 30V直流最大电压，3.3kΩ的输入阻抗 )
24V 动力供应	(+24v)	数字信号源的共享点 ( PW 切换到源 )	±15% ， 最大输出电流：150毫安 ( 所有负 载的总和 )
	COM	数字信号的“通用终端 ( PW切换片 )	
外部电源	PW**	( +24V ) 端连接到PW终 端作为默认t*	默认值 ( +24V )
脉输入信 号	HDI	脉冲或ON- OFFinput，与PW和光耦合 COM	频率范围：0~50kHz的输入电压： 9~30V输入阻抗：1.1KΩ
模拟输入 信号	A11	电压速度指令	( -10V~+10V ) 输入阻抗：20KΩ
	A12	多功能模拟输入端子转换 由J16	从0V~+10V/0~20mA的 输入阻抗：10KΩ ( 电压 ) /250Ω ( 电 流 )
	(+10v)	电源的速度设定	
	GND	模拟信号共享终端	
脉产量信 号	HDO	高速脉冲或集电极开路输 出。相应的公共端为COM	输出频率范围：0~50kHz的
模拟产量 信号	AO1	由J172~3HP：AO1通过J	输出范围：电压 ( 0~10V ) 电流 ( 0~20mA ) 的
	AO2	15和AO2通过J14可以选择	
RS-485 端口	+485	RS-485 / MODBUS***	光电耦合器隔离， 差分输入和输出
	-485		

类型	终端站	终端功能	信号电平
继电器输出	RO1A	RO1常见	触点容量：AC 250V/3A DC 30V/ 1A
	RO1B	RO1常闭 ( NC )	
	RO1C	RO1常开 ( NO )	
	RO2A	RO2常见	
	RO2B	RO2常闭 ( NC )	
	RO2C	RO2常开 ( NO )	

\*如果外部电源是必要的，断开连接 (+24V) 与PW端子和连接外部电源

\*\*使用PW来设置下沉或源模式

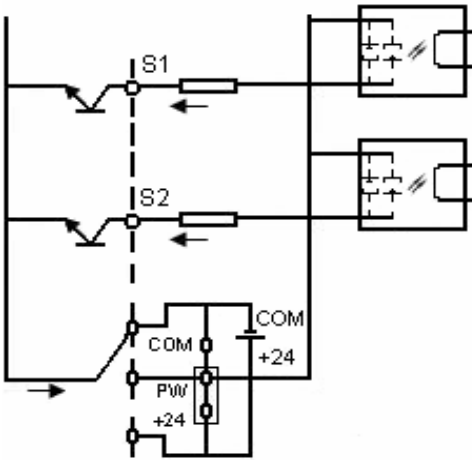

沉模式

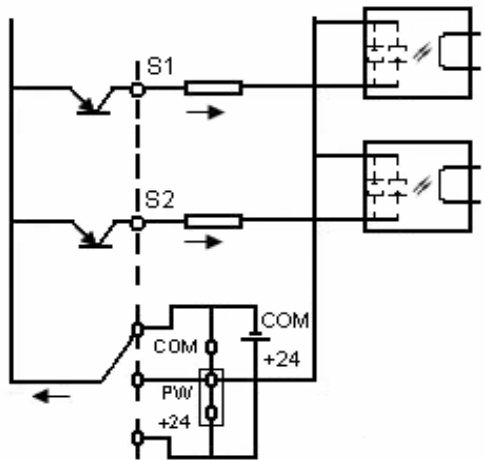

源模式

\*\*\*请的标准通讯端口上使用双绞线和屏蔽电缆

跨接器	描写
J2 , J4	据 被禁止 连接在一起 , 否则会引起变频器。
J16	开关 0~10V和0~20mA的输入 v连接到GND意味着电压输入 我连接到GND意味着电流输入
J15和J17 以上5HP	开关 0~10V和0~20mA输出 v连接到GND意味着电压输出 我连接到GND意味着电流输出
J14 和 J15 2HP~3HP	开关 0~10V和0~20mA输出 v连接到GND意味着电压输出 我连接到GND意味着电流输出
SW1	开关端接电阻的RS485通讯 , 拨至ON指连接到终端电阻器拨号时至OFF表示断开终端电阻。( 仅适用于5HP以上 )
J7	RS-485通信跳线
J17 和 J18 2HP~3HP	开关端接电阻的RS-485通讯。 跳线实现 : 连接终端电阻 跳线关闭 : 断开终端电阻

### 3.3.4 配线注意事项

为控制终端的外部布线，请注意以下事项：

使用屏蔽或双绞线连接控制端子

连接到控制电缆应留远离主电路和强电线路（包括电源线，电机线，继电器，

接触器连线）20cm以上，并应避免平行布线。建议采用垂直布线，以防止外

部干扰引起变频器。

接点输出端子R1A，R1B，R1C（或R2A，R2B，R2C）必须从隔离

终端1~7，A01，A02，GND，HDO，COM，+10V，AI1，AI2，HD1接线时。

为了避免电气噪声的干扰，控制电路接线必须采用屏蔽隔离双绞线

，请参考下面的示意图。

该布线距离不应超过50米。连接接地端子（PE）使用屏蔽电缆。

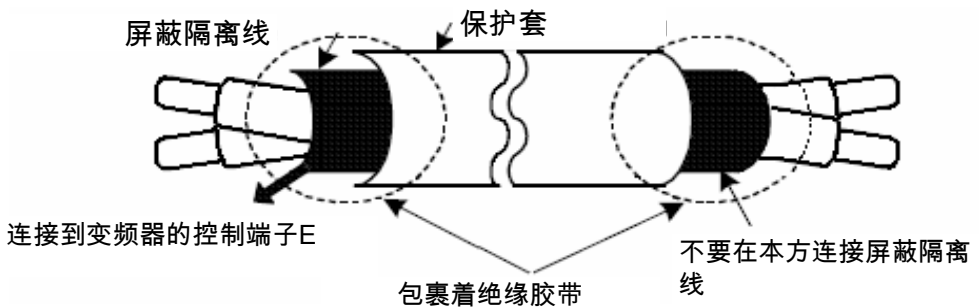

当连接多功能光耦至继电器的输出触点，它是必要的并联添加飞轮二极管给继

电器线圈的两侧，如图如下图。

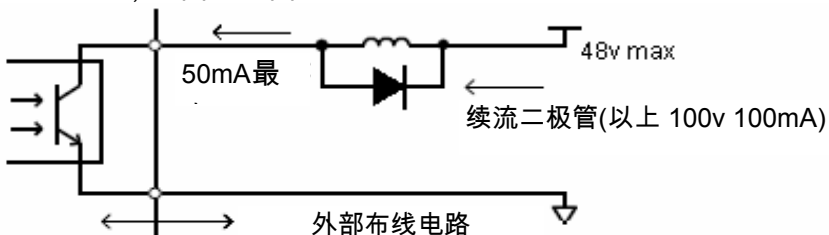

对于主回路端子的接线，请注意以下事项：

它并不需要考虑输入功率R中的相序，S，T。

禁止连接的逆变器输出端子与交流电源的U，V和W。

变频器输出端子U，V和W连接到电机端子U，V，W。如果逆变器执行正转指令，而马达旋转逆转方向，简单地交换的U，V的任何两根导线，W是不够的。

切勿将逆变器输出端连接电容器或LC，RC的噪声滤波器提高功率因数。

接地端子（E）是由第三类型接地方式接地至大地。（接地 $100\Omega$ 以下电阻）电

流负载，- 逆变器接地线不可与高接地作为焊接机和高功率马

达等。它们必须接地分别。

接地导线规格如下电气设备技术规范短接地线，它是更好的。

若多台变频器共同接地，请参考以下图表接地。不要形成接地回路。

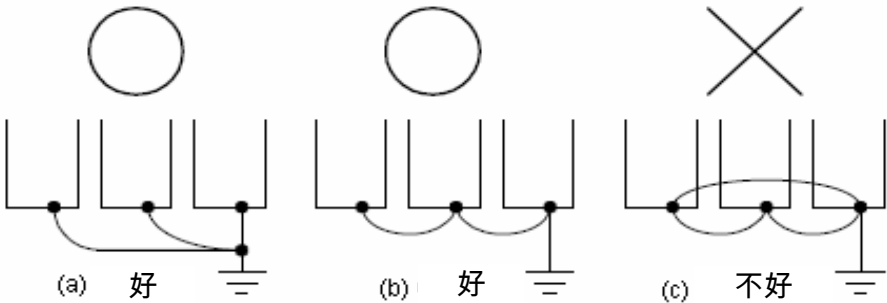

### 确定导线规格：

当选择线，一个考虑的所造成的导线的电压降是一个必须。

电压降的计算如下所示。在一般情况下，电压降应控制在低于额定电压的2%。电线之间的电压降 ( V ) = $\times$ 丝

电阻 (  $\Omega$ /公里 )  $\times$  布线长度 ( m )  $\times$  电流 ( A )  $\times 10^{-3}$

### 交流电抗器并联电源协调：

如果容量超过600KVA，请加交流电抗器来的输入端变频器串联。

AC电力可以用于协调功率和功率因数改进。

### 变频器和电机之间的接线长度：

如果逆变器和电机，逆变器自身和其他之间的总长度

外围设备将受到影响，因为逆变器的高频载波频率 ( 在IGBT接通/断开切换频率 ) 会增加接线和地之间的漏电流。其结果是，如果在逆变器和电动机之间的配线长度很长，请适度降低载波频率，如下所示。

之间的布线距离 逆变器 和 马达	< 30m	30m ~ 50m	50m~100m	$\geq$ 100m
允许的载体 频率 ( 设置P0-14的值 )	15kHz(最大)	10kHz(最大)	5kHz(最大)	2kHz(最大)





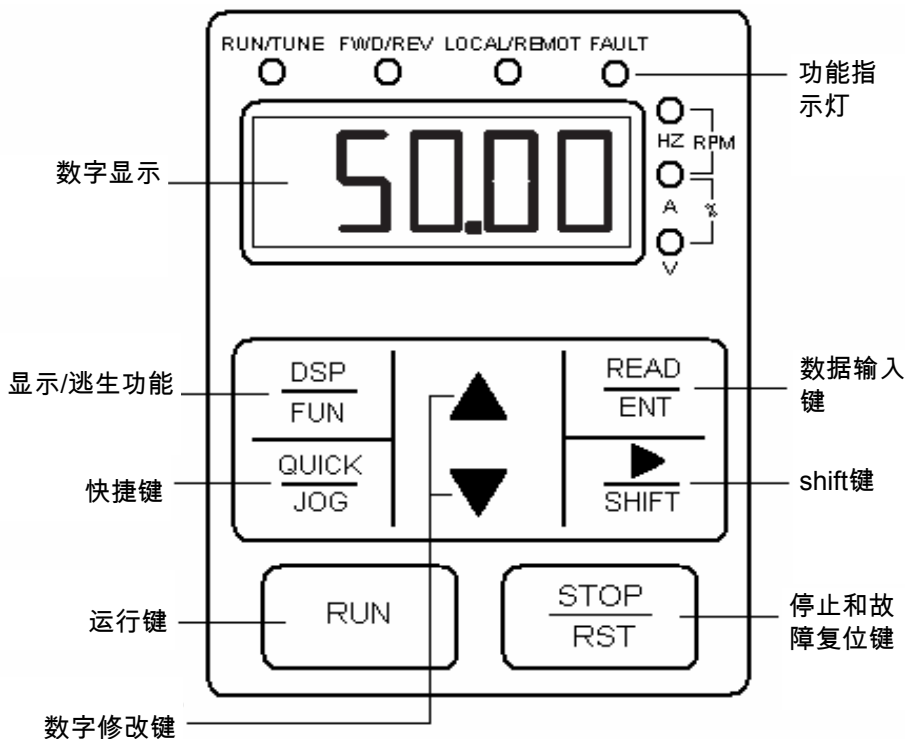

## 第4章键盘和编程功能



重点	命名	功能说明
$\frac{\text{DSP}}{\text{FUN}}$	显示功能/逃生	输入或从第一级菜单退出
$\frac{\text{READ}}{\text{ENT}}$	阅读回车键	逐步进入菜单，确认参数
▲	数字修改键	逐步增加的数据或功能码
▼	数字修改键	递减的数据或功能码
$\frac{\text{▶}}{\text{SHIFT}}$	shift键	在参数设置模式下，按下此按钮可以选择位在其它模式进行修改，通过循环右移显示的参数

重点	命名	功能说明
	运行关键	启动运行在键盘控制模式下，逆变器
	停止/复位键	在运行状态下，由P7.04注册，可以用来停止变频器。当故障报警，可用于复位变频器不受任何限制
	快捷键	确定由功能码P7.03：
		0：显示状态切换
		1：点动操作
		2：在正向和反向开关
		3：清除UP/ DOWN端子设置
 + 	组合键	按下  和  并在
		同时可以实现变频器自由停机

功能指示灯	描写
RUN/TUNE 	熄灭：停止状态 闪烁：参数自整定状态 灯亮：工作状态
FWD/REV 	熄灭：正向运行 指示灯亮起：反向操作
LOCAL/REMOT 	熄灭：键盘控制 闪烁：终端控制 点亮：通信控制

功能指示灯	描写
FAULT 	熄灭：正常运行状态 闪烁：过载预警状态 逆变器故障：在光
HZ	频单元
A	目前单位
V	电压单元
RPM	转速单位
%	百分

#### 4.4.1 键盘操作说明

##### 4.4.1.1 参数设置

按任一 **PRG/ESC** 或 **DATA/ENT** 能返回第二个 -级菜单从第三级菜单

。所不同的是：按 **DATA/ENT** 将保存在控制面板的设定参数，然后再

返回到第二级菜单与转移到下一个功能码。按 **PRG/ESC** 将返回到第二

级菜单不保存参数，并保持停留在当前功能码。

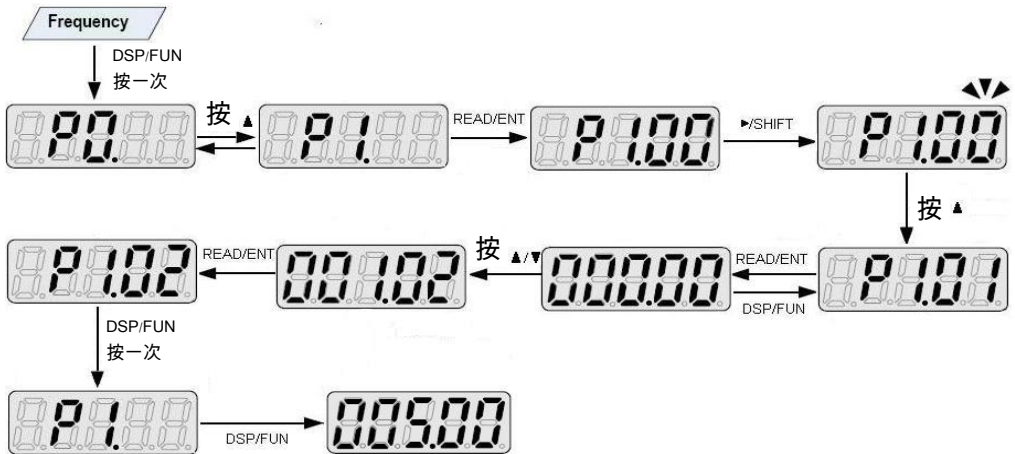

在第三个 - 级菜单，如果参数没有闪烁位,这意味着功能码不能被修改。  
可能的原因可能是：

这个功能是不可修改参数，如实际检测的参数运行记录等。

这个功能是不可修改的运行模式。

### 快捷菜单 QUICK/JOG

快捷菜单提供了一种快速的方法来查看和修改功能参数。

设置P7.03为4，然后按 QUICK/JOG 键，变频器将搜索这是从出

厂设置不同，保存这些数据超过32，参数也无法显示过长的部分。按

QUICK/JOG将快捷调试模式。如果 QUICK/JOG 显示“NULLP”，这意

味着该参数是相同的出厂设置。

如果想

返回到上显示，按 QUICK/JOG

### 故障复位

如果发生到逆变器故障，它会通知相关故障信息.用户可以使用STOP/ RST  
或P5组确定复位故障根据终端。

故障复位以后，变频器处于待机 - 由国家。如果用户不复位故障逆变器将在  
操作中保护状态，而无法运行。

## 第5章外形尺寸图

### 标准型

(a) 380V : 20HP ~ 40HP

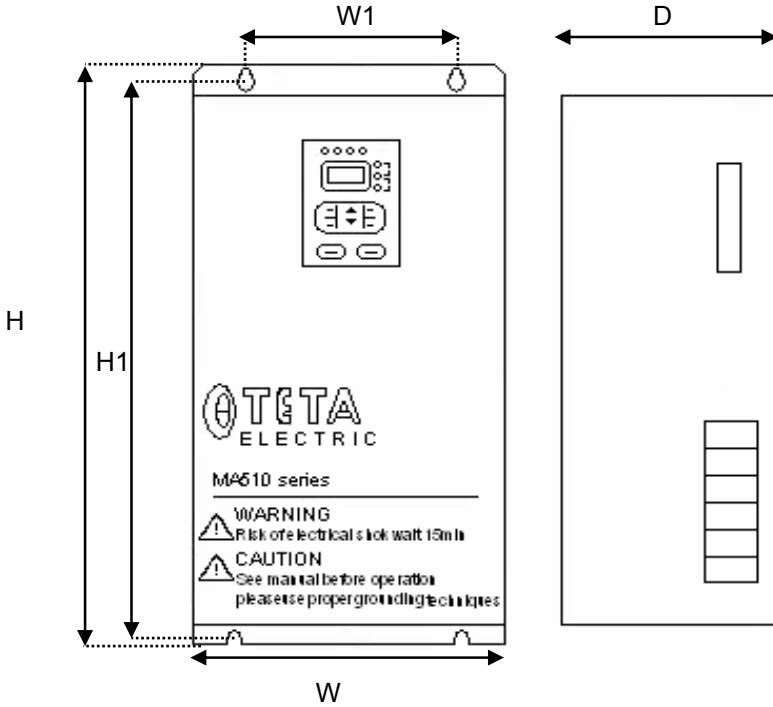

变频器型号	尺度 (mm)					
	W	H	D	W1	H1	GW(kg)
MA510 4025	290	470	215	175	460	12
MA510 4030	290	470	215	175	460	12
MA510 4040	290	470	215	175	460	12

(b) 380V : 50HP ~ 75HP

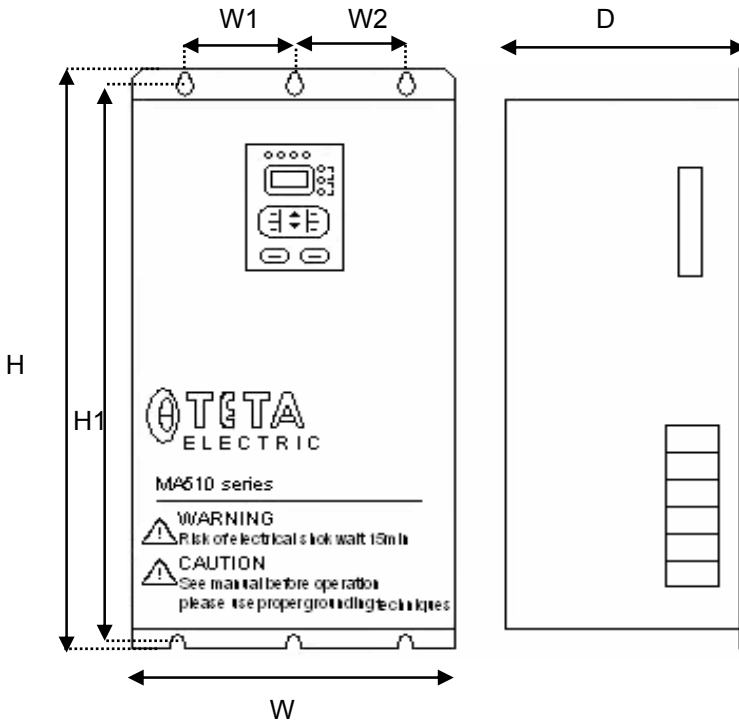

变频器型号	尺度 (mm)					
	W	H	D	W1/W2	H1	GW(kg)
MA510 4050	375	585	270	115	665	36
MA510 4060	375	585	270	115	665	36
MA510 4075	375	585	270	115	665	36

(c) 380V : 100HP ~ 150HP

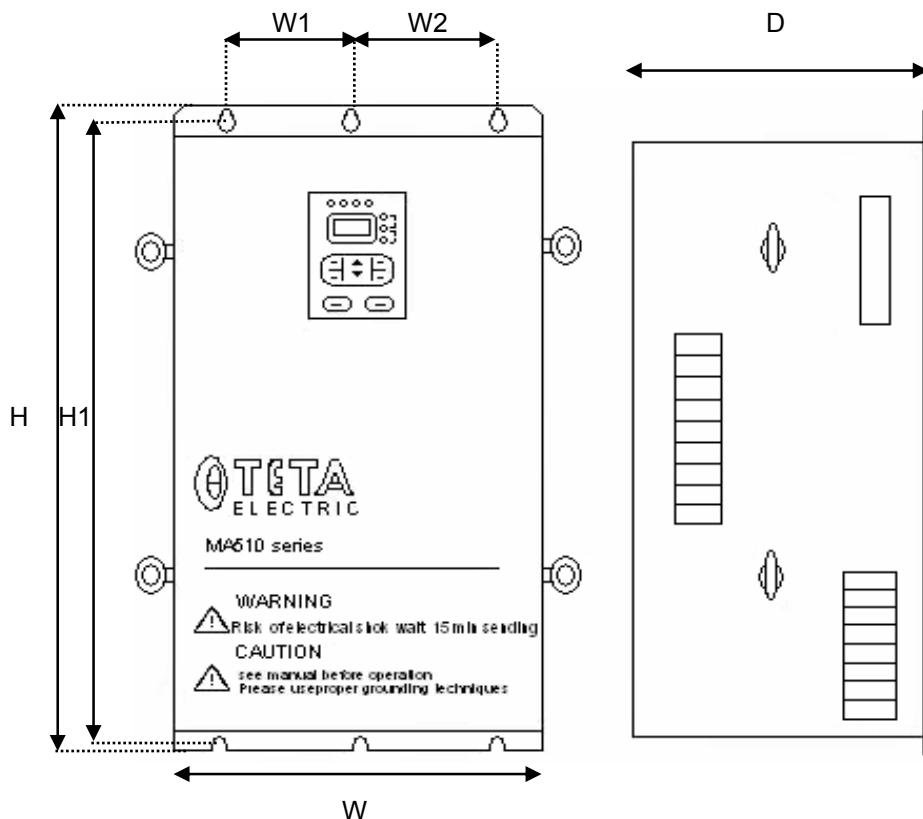

变频器型号	尺度 (mm)					
	W	H	D	W1/W2	H1	GW(kg)
MA510 4100	460	755	330	160	735	48
MA510 4125	460	755	330	160	735	48
MA510 4150	460	755	330	160	735	50

## 键盘尺寸

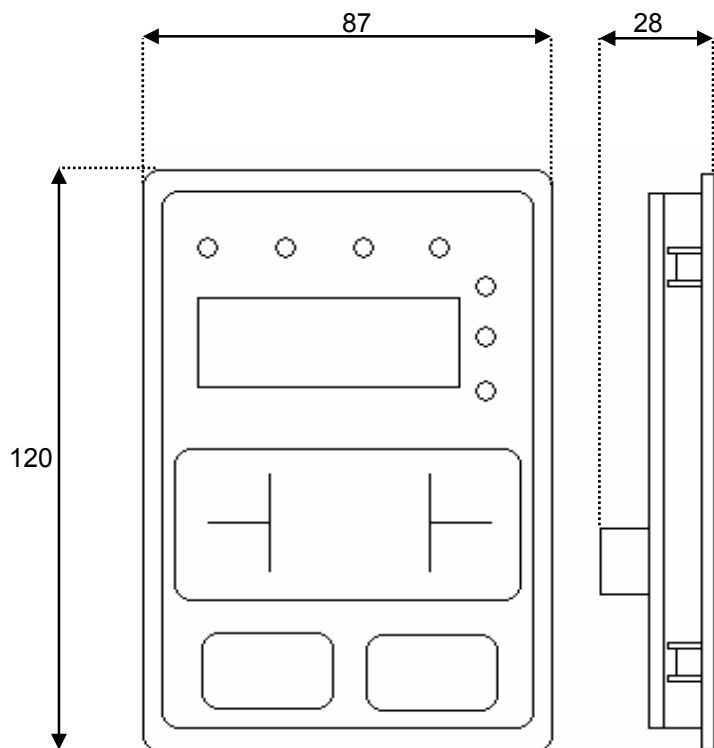



## 第6章 制动电阻

型号	输入电压	制动电阻	使用数	制动单元	使用数
MA510-2002	3-相 220V + 15%	260W/130Ω	1	----	0
MA510-2003		260W/80Ω	1	----	0
MA510-2005		400W/48Ω	1	----	0
MA510-2008		550W/35Ω	1	----	0
MA510-2010		780W/26Ω	1	----	0
MA510-2015		1100W/17Ω	1	----	0
MA510-2020		1800W/13Ω	1	----	0
MA510-2025		2000W/10Ω	1	70	1
MA510-2030		2500W/8Ω	1	80	1
MA510-2040		1800W/13Ω	2	110	2
MA510-2050		2000W/10Ω	2	130	2
MA510-2060		2500W/8Ω	2	160	2
MA510-2075		3000W/6.5Ω	2	190	2
MA510-4002	3-相 380V + 15%	260W/400Ω	1	----	0
MA510-4003		390W/150Ω	1	----	0
MA510-4005		390W/150Ω	1	----	0
MA510-4008		520W/100Ω	1	----	0
MA510-4010		1040W/50Ω	1	----	0
MA510-4015		1040W/50Ω	1	----	0
MA510-4020		1560W/40Ω	1	----	0
MA510-4025		6000W/20Ω	1	37	1
MA510-4030		6000W/20Ω	1	45	1
MA510-4040		6000W/20Ω	1	60	1
MA510-4050		9600W/13.6Ω	1	75	1
MA510-4060		9600W/13.6Ω	1	90	1
MA510-4075		9600W/13.6Ω	1	110	1

型号	输入电压	额定功率额定	输入电流	额定输出电流	支持汽车
MA510-4100		9600W/13.6Ω	2	150	2
MA510-4125		9600W/13.6Ω	2	176	2
MA510-4150		9600W/13.6Ω	2	210	2
MA510-4175		3000W/4Ω	1	250	1
MA510-4215		3000W/4Ω	1	300	1
MA510-4250		4000W/3Ω	1	340	1

在制动模块和制动电阻的安装，你需要不断的从逆变器适当距离，并保持安装环境的良好通风。

根据公司提供的数据选择制动单元的电阻和功率。

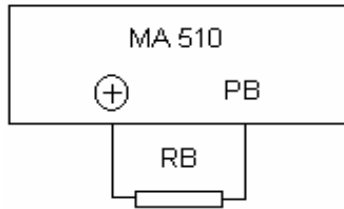

外接制动电阻

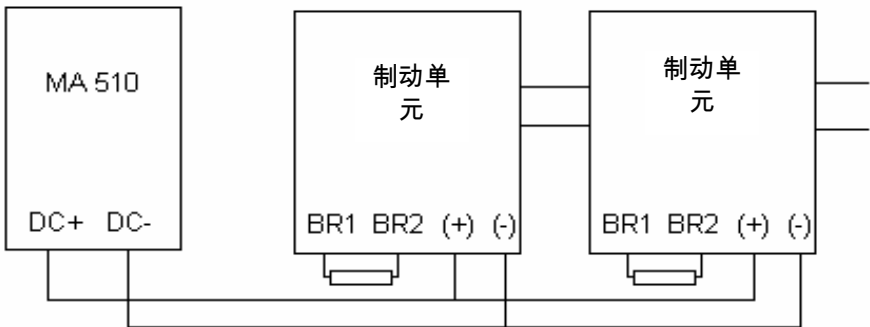

外部制动单元并联

## 第7章 参数表

参数组	命名
P0集团	基本职能
P1组	启动和停止控制
P2组	电机参数
P3组	矢量控制
P4组	V / F控制
P5组	输入端子
P6组	输出端子
P7组	人机界面
P8组	增强功能
P9组	PID控制
PA集团	简易PLC及多段速控制
PB集团	保护功能
PC集团	串行通信
PD组	辅助功能
PE组	出厂设置

P0组：基本功能				
功能代码	名称	说明	设定范围	默认
P0.00	控制	0：V/F控制 1：无传感器矢量控制 2：转矩控制(无传感器矢量控制)	0~2	0
P0.01	跑命令资源	0：键盘（LED熄灭） 1：端子（LED闪烁） 2：通讯（LED灯）	0~2	0
P0.02	键盘和终端 UP/DOWN 环境	0：有效，节约UP/DOWN值 当电源关闭 1：有效，不保存UP/DOWN值时， 关闭电源 2：无效 3：运行期间有效，清楚何时停止	0~3	0
P0.03	最大频率	10.00~400.00Hz	10.00 ~ 400.00Hz	50.00Hz
P0.04	最大频率	P0.05~P0.03 (最高频率)	P0.05 ~ P0.03	50.00Hz
P0.05	频率上限	0.00~P0.04 (下限频率)	P0.05 ~ P0.04	0.00Hz
P0.06	键盘参考频率	0.00~P0.03 (最高频率)	0.00 ~ P0.03	50.00Hz

功能代码	名称	说明	设定范围	默认
P0.07	频次 A 命令源	0 : 键盘 1 : AI1 2 : AI2 3 : HDI 4 : 简易PLC 5 : 多段速 6 : PID 7 : 远程通讯	0~7	0
P0.08	频次 B 命令源	0: AI1 1: AI2 2: HDI	0~2	0
P0.09	的规模频率B 命令	0 : 最高频率 1 : 频率命令	0~1	0
P0.10	频率指令选 择	0: A 1: B 2: A+B 3: Max(A and B)	0~3	0
P0.11	加速时间0	0.1~3600.0s	0.1 ~ 3600.0s	依靠 模型
P0.12	减速时间0	0.1~3600.0s	0.1 ~ 3600.0s	依靠模型
P0.13	跑方向选择	0 : 前峰 1 : 反转转 2 : 禁止反转	0~2	0
P0.14	运营商频率	1.0~15.0kHz	1.0 ~ 15.0kHz	依靠模型

功能代码	名称	说明	设定范围	默认
P0.15	AVR功能	0 : 无效 1 : 有效的所有的时间 2 : 只在减速有效	0~2	1
P0.16	汽车参数自动调整	0 : 无动作 1 : 旋转自动调整 2 : 静态自学习	0~3	2
P0.17	恢复参数	1 : 恢复出厂设置 2 : 清除故障记录	P0.17	P0.17
<b>P1组：启动和停止控制</b>				
P1.00	启动模式	0 : 直接启动 1 : 直流制动和启动 2 : 转速追踪再启动	0.2	0
P1.01	启动频率	0.00~10.00Hz	0.00 ~ 10.00	0.00Hz
P1.02	保持起动机频率时间	0.0~50.0s	0.0~50.0	0.0s
P1.03	直流制动电流之前开始	0.0~150.0%	0.0~150.0	0
P1.04	直流制动时间开始前	0.0~50.0s	0.0~50.0	0.0s
P1.05	促进减速模式	0 : 直线 1 : 保留	0~1	0

功能代码	名称	说明	设定范围	默认
P1.06	停止模式	0 : 减速停止 1 : 自由停车	0~1	0
P1.07	直流制动启动频率	0.00~P0.03	0.00 ~ P0.03	0.00Hz
P1.08	直流制动前的等待时间	0.0~50.0s	0.0~50.0	0.0s
P1.09	直流制动电流	0.0~150.0s	0.0~150.0	0
P1.10	直流制动时间	0.0~50.0s	0.0~50.0	0.0s
P1.11	FWD/ REV的死区时间	0.0~3600.0s	0.0 ~ 3600.0	0.0s
P1.12	操作时运行频率小于频率下限(有效时频率下限为大于0)	0 : 运行在较低的频率30 限 1 : 停止 2 : 待机	0~2	0

功能代码	名称	说明	设定范围	默认
P1.13	延迟时间重 启	0.0~3600.0s (有效时 P1.12=2)	0.0 ~ 3600.0	0
P1.14	断电后重新 启动	0 : 禁用 1 : 启用	0~1	0
P1.15	等待重启的 时间	0.0~3600.0s (有效时 P1.14=1)	0.0 ~ 3600.0	0.0s
P1.16	终端检测到 选择当电源 开启	0 : 禁用 1 : 启用	0~1	0
P1.17	版权所有			
P1.18	版权所有			
P1.19	版权所有			
<b>P2组：电机参数</b>				
P2.00	逆变器 模型	0 : G型 1 : P型	0~1	依靠模型
P2.01	电机额定功 率	0.4~900.0kW	0.4 ~ 3000.0	依靠模型
P2.02	电机额定 频率	0.01Hz~P0.03	10.00 ~ P0.0	50.00Hz
P2.03	电机额定 速度	0~36000pm	0.0 ~ 3600.0	依靠模型
P2.04	电机额定 电压	0~800V	0~800	依靠模型
P2.05	电机额定 当前	0.8~6000.0A	0.8 ~ 6000.0	依靠模型



功能代码	名称	说明	设定范围	默认
P2.06	电机定子电阻	0.001~65.535Ω	0.001 ~ 65.535	依靠模型
P2.07	电机转子电阻	0.001~65.535Ω	0.001 ~ 65.535	依靠模型
P2.08	发动机 泄漏 电感	0.1~6553.5mH	0.1 ~ 6553.5	依靠模型
P2.09	发动机 泄漏 电感	0.1~6553.5mH	0.1 ~ 6553.5	依靠模型
P2.10	空载电流	0.1~6553.5A	0.1 ~ 6553.5	依靠模型

### P3组：矢量控制

P3.00	ASR 成比例的 获得的Kp1	0~100	0~100	20
P3.01	ASR积分时 间的Kp1	0.01~10.00s	0.01 ~ 10.00	0.50S
P3.02	ASR 交换 点1	0.00Hz~P3.05	0.00 ~ P3.05	5.00Hz
P3.03	ASR 成比例的 获得KP2	0~100	0~100	25
P3.04	ASR积分时 间KP2	0.01~10.00s	0.01 ~ 10.00	1.00s

功能代码	名称	说明	设定范围	默认
P3.05	ASR 交换 2点	P3.02~P0.03 (最大频率)	P3.02 ~ P0.03	10.00Hz
P3.06	滑VC补偿费	50.0%~200.0%	50~200	100%
P3.07	转矩上限	0.0~200% (的额定电流)	0.0~200.0	G 型: 150.00% P 型: 120.00%
P3.08	扭力 环境 资源	0: 0 : 键盘 ( 相当于P3.09 ) 1: AI1 2: AI2 3: HDI 4: 多段速 5: 远程通讯 (1~5: 100% 对应 于逆变器的 额定电流的2倍)	0~5	0
P3.09	键盘扭矩设置	(-200.0%~200.0%) ( 逆变器的额定电流 )	(-200.0% ~200.0%)	50.00%
P3.10	上限频率设定源	0 : 键盘 ( P0.04 ) 1: AI1 2: AI2 3: HDI 4 : 多段 5: 远程通信 ( 1~4 : 100%对应最大频率 )	0~5	0

P4组：V / F控制				
功能代码	名称	说明	设定范围	默认
P4.00	V / F 曲线选择	0：线性曲线 1：Multidots曲线 2：torque_stepdown曲线 ( 1.3顺序 ) 3：Torque_stepdown曲线 ( 1.77顺序 ) 4：Torque_stepdown曲线 ( 2.0顺序 )	0~4	0
P4.01	转矩提升	( 自动 ) 0.1%~10.0%	0.0 ~ 10.0	0.00%
P4.02	转矩提升截止f	0.0%~50.0% ( 电机额定频率 )	0.0 ~ 50.0	20.00%
P4.03	V / F频率1	0.00Hz~P4.05	0.00 ~ P4.05	0.00Hz
P4.04	V / F电压1	0.0%~100.0% ( 电机的额定电压 )	0.0 ~ 100.0	0.00%
P4.05	V / F频率2	P4.03~P4.07	P4.03 ~ P4.7	0.00Hz
P4.06	V / F电压2	0.0%~100.0% ( 电机的额定电压 )	0.0 ~ 100.0	0.00%
P4.07	V / F频率3	P4.05~ P2.02 ( 电机的额定频率 )	P4.05 ~ P2.02	00.00Hz
P4.08	V / F电压3	0.0%~100.0% ( 电机的额定电压 )	0.0 ~ 100.0	0.00%
P4.09	滑差补偿限额	0.00~200.0%	0.0~200	0.00%

功能代码	名称	说明	设定范围	默认
P4.10	自动节能选择	0: 禁用 1: 启用	0~1	0
P4.11	抑制振荡低频阈值	0~10	0~10	2
P4.12	抑制振荡的高频阈值	0~10	0~10	0
P4.13	抑制振动的边界	0.0~P3.03	0.00 ~ P0.03	30.00Hz

#### P5组：输入端子

P5.00	HDI选择	0：高速脉冲输入 1：ON-OFF输入	0~1	0
P5.01	S1端子功能	0：无效 1：正向	0~39	1
P5.02	S2端子功能	2：反转 3：3线控制	0~39	4
P5.03	S3端子功能	4：点动正 5：反转点动	0~39	7
P5.04	S4端子功能	6：自由停车 7：故障复位	0~39	0
P5.05	S5端子功能	8：暂停运行 9：外部故障输入	0~39	0

功能代码	名称	说明	设定范围	默认
P5.06	S6端子功能	10 : UP指令 11 : DOWN指令	0~39	0
P5.07	S6端子功能	12 : 清除UP / DOWN 13 : A和B之间切换	0~39	0
P5.08	HDI端子功能	14 : A和A + B之间切换 15 : B和A + B之间切换 16 : 多段速定1 17 : 多段速给定2 18 : 多段速定3 19 : 多段速定4 20 : 多段速暂停 21 : 加速/减速时间选择1 22 : 加速/减速时间选择2 23 : 重设简易PLC时停止 24 : 暂停简易PLC 25 : 暂停PID 26 : 暂停遍历操作 27 : 暂停遍历操作 28 : 重设计数器 29 : 复位长度 30 : 加/减速斜坡保持 31 : 计数器输入 32 : UP / DOWN暂时无效 33-39 : 保留	0~39	0
P5.09	ON-OFF 滤波时间	1~10	1~10	5

功能代码	名称	说明	设定范围	默认
P5.10	终端控制模式	0 : 2线控制模式1 1 : 2线控制模式2 2 : 3线控制模式1 3 : 三线式控制模式2	0~3	0
P5.11	UP/ DOWN 设定变化率	0.01~50.00Hz/s	0.01~50.0 0	0.50Hz/s
P5.12	AL1下限	0.00V~10.00V	-10.00~10.	0.00V
P5.13	AL1 相应设置下限	-100.0%~100.0%	-100.0~100	0.00%
P5.14	AL1下限	0.00V~10.00V	-10.00~10.	10.00V
P5.15	AL1下限对 应的设定	-100.0%~100.0%	-100.0~100	100.00%
P5.16	AL1滤波器 时间常数	0.00s~10.00s	0.00~10.00	0.10s
P5.17	AL2下限	0.00V~10.00V	0.00~10.00	0.00V
P5.18	AL2下限对 应的设定	-100.0%~100.0%	-100.0~100	0.00%

功能代码	名称	说明	设定范围	默认
P5.19	AL2上限	0.00V~10.00	0.000~10.0	10
P5.20	AL2上限对应设置	-100.0%~100.0%	-100.0~100	100.00%
P5.21	AI2滤波时间常数	0.00s~10.00s	0.00~10.00	0.10s
P5.22	HDI下限	0.0kHz	0.00~50.00	0.00kHz
P5.23	HDI下限对应的设定	-100.0%~100.0%	-100.0~100	0.00%
P5.24	HDI上限	0.0kHz~50.0kHz	0.00~50.00	50.00kHz
P5.25	HDI下限设定	-100.0%~100.0%	-100.0~100	100%
P5.26	HDI滤波器时间常数	0.00s~10.00s	0.00~10.00	0.10s

### P6组：输出端子

P6.00	HDO选择	0：无输出 1：运行 2：正向运行 3：运行反 4：故障输出	0~1	0
P6.01	HDO ON-OFF输出选择		0~20	1

功能代码	名称	说明	设定范围	默认
		5 : FDT达到 6 : 频率到达 7 : 零速运行 8 : 预置计数值达到 9 : 指定计数值达到 10 : 长度达到 11 : 简易PLC阶段完成 12 : PLC 周期 完成 13 : 运行时间达到		
P6.02	继电器1输出选择	14 : 上限频率到达 15 : 下限频率达到 16 : 阅读	0~20	4
P6.03	继电器2输出选择	17 : 辅助电机1日开始 18 : 辅助电机2开始 19~20 : 保留	0~20	0
P6.04	AO1功能选择	0 : 运行频率 1 : 参考频率 2 : 转速	0-10	0
P6.05	AO2功能选择	3 : 输出电流 4 : 输出电压	0-10	0
P6.06	HDO功能选择	5 : 输出功率 6 : 输出转矩 7 : AL1电压 8 : 的AI2电压/电流 9 : HDI频率	0-10	0
P6.07	AO1下限	0.0%~100%	0.0~100.0	0.00%



功能代码	名称	说明	设定范围	默认
P6.08	AO1下限对应的输出	0.00V~10.00V	0.00~10.00	0.00V
P6.09	AO1上限	0.00V~10.00V	0.0~100.0	100.00%
P6.10	AO1上相应限制输出	0.00V~10.00V	0.00~10.00	10.00V
P6.11	AO2下限	0.0~100.0%	0.0~100.0	0.00%
P6.12	AO2下限对应的输出	1~10.00V	0.00~10.00	0.00V
P6.13	AO2上限	0.0~100.0%	0.0~100.0	100.00%
P6.14	AO2上相应限制输出	0.00~10.00V	0.00~10.00	10.00V
P6.15	HDO下限	0.00%~100.00%	0.00~100.0	0.00%
P6.16	HDO下限对应的输出	0.000~50.000KHz	0.000~50.0	0.00KHz

功能代码	名称	说明	设定范围	默认
P6.17	HDO上限	0.00%~100.00%	0.000~100.	100.00%
P6.18	HDO上限对应的输出	0.0~50.0KHz	0.000~50.0	50.00KHz
<b>P7组：人机界面</b>				
P7.00	用户密码	0~65535	0~65535	0
P7.01	储备		版权所有	版权所有
P7.02	储备		版权所有	版权所有
P7.03	<u>QUICK/</u> <u>JOG功能选择</u>	0：显示状态切换 1：点动 2：FWD / REV切换	0~4	0
		3：清除UP / DOWN设定 4：快速设置模式		
P7.04	<u>STOP/</u> <u>RST功能选择</u>	0：有效键盘控制 ( P0.03 = 0 ) 1：有效时，键盘或端子控制 ( P0.03 = 0 OR 1 ) 2：有效时，键盘或通讯控制 ( P0.03 = 0或2 ) 3：始终有效	0~3	0
P7.05	键盘显示选择	0：优先于外部键盘 1：这两种显示，只有外部密钥有效 2：两个显示，只有本地密钥有效	0~3	0

功能代码	名称	说明	设定范围	默认
		3 : 显示和按键有效。		
P7.06	运行状态显示选择1	0~0XFFFF 位0 : 运行频率 BIT1 : 参考频率 位2 : 直流母线电压 BIT3 : 输出电压 位4 : 输出电流 位5 : 转速 位6 : 线速度 BIT7 : 输出功率 BIT8 : 输出转矩 BIT9 : PID预设 BIT10 : PID反馈 BIT11 : 输入端子状态 BIT12 : 输出端子状态 BIT13 : 转矩设定值 BIT14 : 计数值	0~0XFFFF	0X07FF
P7.07	运行状态显示选择2	0~0XFFFF 位0 : AI1 BIT1 : AI2 位2 : HDI频率 BIT3 : 电机负载百分比 位4 : 变频器负载百分比 第5~15 : 保留	0~0XFFFF	0

功能代码	名称	说明	设定范围	默认
P7.08	停机状态显示的选择	0~0xFFFFF BIT0：给定频率 BIT1：直流母线电压 BIT2：输入端子状态 BIT3：输出端子状态 BIT4：PID设定 BIT5：PID反馈 BIT6：AI1 BIT7：AI2 BIT8：HDI频率 BIT9：步骤 PLC或多步  BIT10：转矩设定值 BIT11~BIT15：保留	0~0XFFFF	0x00ff
P7.09	旋转速度的系数	0.0~999.9% 实际机械速度= $120 * \text{输出频率} * \text{电机的极P7.09 / 数}$	0.1~999.9	100.00%
P7.10	线速度系数	0.0~999.9% 线速度=实际 机械转速* P7.10	0.1~999.9	1.00%
P7.11	整顿模块温度	0~100.0		
P7.12	IGBT模块温度	0~100.0		

功能代码	名称	说明	设定范围	默认
P7.13	软件版本			
P7.14	变频器额定功率	0.4~3000.0KW	0.4~3000.0	依靠模型
P7.15	变频器额定电流	0.0~6000.0A	0.0~6000.0	依靠模型
P7.16	累计运行时间	0~65535H		
P7.17	第三次故障类型	0 : 不断裂 1 : IGBT PH-U故障 ( OUT1 )		
P7.18	第二次故障类型	2 : IGBT PH-V故障 ( OUT1 ) 3 : IGBT PH-W故障 ( OUT1 ) 4 : 过电流时, 加速度 ( OC1 )		
P7.19	最新的故障类型	5 : 过电流时, 减速 ( OC2 )  6 : 过电流, 当恒 高速运行 ( OC3 ) 7 : 过电流时的加速度 ( OV1 )  8 : 过电流时, 减速 ( OV2 )  9 : 过电流时, 恒高速运行 ( OV3 )  10 : DC总线欠压 ( UV ) 11 : 电机过载 ( OL1 ) 12 : 变频器过载 ( OL2 )		

功能代码	名称	说明	设定范围	默认
		13 : 输入缺相故障 ( SPO ) 14 : 输出缺相 ( SPO ) 15 : 整顿过热 ( OH1 ) 16 : IGBT过热 ( OH ) 17 : 外部故障 ( EF ) 18 : 通讯故障 ( CE ) 19 : 电流检测故障 ( ITE ) 20 : 自动调谐故障 ( TE ) 21 : EEPROM故障 ( EEP ) 22 : PID反馈故障 ( PIDE ) 23 : 制动单元故障 ( BCE ) 24 : 运行时间到达 ( END ) 25 : 转矩故障 ( OL3 )		
P7.20	输出频率电 流故障			
P7.21	输出电流的 电流故障			
P7.22	在当前故障 母线电压			
P7.23	在当前故障 输入端子状 态			
P7.24	在当前故障 输出端子状 态			

P8组：增强功能				
功能代码	名称	说明	设定范围	默认
P8.00	加速时间1	0.1~3600.0s	0.1~3600.0	依靠模型
P8.01	减速时间1	0.1~3600.0s	0.1~3600.0	依靠模型
P8.02	加速时间2	0.1~3600.0s	0.1~3600.0	依靠模型
P8.03	减速时间2	0.1~3600.0s	0.1~3600.0	依靠模型
P8.04	加速时间3	0.1~3600.0s	0.1~3600.0	依靠模型
P8.05	减速时间3	0.1~3600.0s	0.1~3600.0	依靠模型
P8.06	点动参考	0.0~P0.03	0.00~P0.03	5.00Hz
P8.07	点动加速时间	0.1~3600.0s	0.1~3600.0	依靠模型
P8.08	点动减速时间	0.1~3600.0s	0.00~P0.03	依靠模型
P8.09	跳过频率1	0.00~P0.03	0.00~P0.03	0.00Hz
P8.10	跳过频率2	0.00~P0.03	0.00~P0.03	0.00Hz
P8.11	跳跃频率宽度	0.00~P0.03	0.00~P0.03	0.00Hz
P8.12	特拉弗斯幅度	0.0~100.0%	0.0~100.0	0.00%

功能代码	名称	说明	设定范围	默认
P8.13	抖动频率	0.0~50.0%	0.0~50.0	1.00%
P8.14	上升遍历时间	0.1~3600.0s	0.1~3600.0	5.0s
P8.15	秋季遍历时间	0.1~3600.0s	0.1~3600.0	5.0s
P8.16	自动复位时间	0~3	0~3	0
P8.17	复位的时间间隔	0.1~100.0s	0.1~100.0	1.0s
P8.18	预置计数值	P8.19~65535	P8.19~655	0
P8.19	指定的计数值	0~P8.18	0~P8.18	0
P8.20	预设运行时间	0~65535	0~65535	65535h
P8.21	FDT电平	0.00~P0.03	0.00~P0.03	50.00Hz
P8.22	FDT滞后	0.0~100.0%	0.0~100.0	5.00%
P8.23	频率到达检测范围	0.0~100.0% (最高频率)	0.0~100.0	0.00%
P8.24	下垂控制	0.00~10.00Hz	0.00~10.00	0.00Hz
P8.25	制动阈值电压	115.0~140.0%	115.0~140	130.00%
P8.26	冷却风扇控制	0 : 自动停止模式 1 : 始终工作	115.0~140	120.00%



功能代码	名称	说明	设定范围	默认
P8.27	过调制	0 : 启用 1 : 禁用	0~1	0
P8.28	PWM模式	0 : PWM模式1 1 : PWM模式2 2 : PWM模式3	0~1	0
<b>P9组 : PID控制</b>				
P9.00	PID设定源选择	0 : 键盘 1 : AI1 2 : AI2 3 : HDI 4 : 多段 5 : 远程通讯	0~5	0
P9.01	键盘PID预设	0.0%~100.0%	0.0~100.0	0.00%
P9.02	PID反馈源选择	0 : AI1 1 : AI2 2 : AI1+ AI2 3 : HDI 4 : 通信	0~3	0
P9.03	PID输出特性	0 : 正 1 : 负	0~1	0
P9.04	比例增益 ( KP )	0.00~100.00	0.00~100.0	0.10s
P9.05	积分时间 ( TI )	0.00~10.00s	0.01~10.00	0.10s
P9.06	微分时间 ( TD )	0.00~10.00s	0.00~100.0	0.01s

功能代码	名称	说明	设定范围	默认
P9.07	采样周期 ( T )	0.01~100.00s	0.00~100.0	0.00%
P9.08	偏差极限	0.0~100.0%	0.0~100.0	0.00%
P9.09	反馈丢失的 检测值	0.0~100.0%	0.0~100.0 %	0.00%
P9.10	反馈丢失检 测时间	0.0~3600.0s	0.0~3600. 0	1.0s

**PA组：简易PLC及多段速控制**

PA.00	简易PLC	0：一个周期后停止 1：一个循环后保持最后的频率 2：循环运行	0~2	0
PA.01	简易PLC状 态保存断电 后	0：禁用 1：启用	0~1	0
PA.02	多段速0	-100.0~100.0%	-100.0~100	0.00%
PA.03	运行时间第 0个步骤	0.0~6553.5s(h)	0.0~6553.5	0.0s
PA.04	多段速1	-100.0~100.0%	-100.0~100	0.00%
PA.05	运行时间第 1步	0.0~6553.5s(h)	0.0~6553.5	0.0s

功能代码	名称	说明	设定范围	默认
PA.06	多段速2	-100.0~100.0%	-100.0~100	0.00%
PA.07	运行时间 第2步	0.0~6553.5s(h)	0.0~6553.5	0.0s
PA.08	多段速3	-100.0~100.0%	-100.0~100	0.00%
PA.09	运行时间 第3步	0.0~6553.5s(h)	0.0~6553.5	0.0s
PA.10	多段速4	-100.0~100.0%	-100.0~100	0.00%
PA.11	运行时间 第四步	0.0~6553.5s(h)	0.0~6553.5	0.0s
PA.12	多段速5	-100.0~100.0%	-100.0~100	0.00%
PA.13	第五步运行 时的速度6	0.0~6553.5s(h)	0.0~6553.5	0.0s
PA.14	多步	-100.0~100.0%	-100.0~100	0.00%
PA.15	第6步运行 时间	0.0~6553.5s(h)	0.0~6553.5	0.0s
PA.16	多段速7	-100.0~100.0%	-100.0~100	0.00%
PA.17	第七步运 行时间	0.0~6553.5s(h)	0.0~6553.5	0.0s
PA.18	多段速8	-100.0~100.0%	-100.0~100	0.00%
PA.19	运行时间8 步	0.0~6553.5s(h)	0.0~6553.5	0.0s

功能代码	名称	说明	设定范围	默认
PA.20	多段速9	-100.0~100.0%	-100.0~100	0.00%
PA.21	运行时间 第九步	0.0~6553.5s(h)	0.0~6553.5	0.0s
PA.22	多段速10	-100.0~100.0%	-100.0~100	0.00%
PA.23	第十步运行 时间	0.0~6553.5s(h)	0.0~6553.5	0.0s
PA.24	多段速11	-100.0~100.0%	-100.0~100	0.00%
PA.25	运行时间11 步骤	0.0~6553.5s(h)	0.0~6553.5	0.0s
PA.26	多段速12	-100.0~100.0%	-100.0~100	0.00%
PA.27	运行时间12 步骤	0.0~6553.5s(h)	0.0~6553.5	0.0s
PA.28	多段速13	-100.0~100.0%	-100.0~100	0.00%
PA.29	运行时间13 步骤	0.0~6553.5s(h)	0.0~6553.5	0.0s
PA.30	多段速14	-100.0~100.0%	-100.0~100	0.00%
PA.31	运行时间14 步骤	0.0~6553.5s(h)	0.0~6553.5	0.0s
PA.32	多段速15	-100.0~100.0%	-100.0~100	0.00%

功能代码	名称	说明	设定范围	默认
PA.33	运行时间15 步骤	0.0~6553.5s(h)	0.0~6553.5	0.0s
PA.34	加/减速时间 选择为步0 ~7	0~0XFFFF	0~0XFFFF	0
PA.35	步8~15加/ 减速时间选 择	0~0XFFFF	0~0XFFFF	0
PA.36	简易PLC重 启选择	0：重新开始从步骤0 1：从暂停的步骤继续	0~1	0
PA.37	时间单位	0：第二 1：分钟	0~1	0
<b>PB组：保护功能</b>				
Pb.00	输入断相 保护	0：禁用 1：启用	0~1	1
Pb.01	输出断相 保护	0：禁用 1：启用	0~1	1
Pb.02	电机过载 保护	0：禁用 1：普通电机（带低速补偿） 2：变频电机（不带低速补偿）	0~2	2

功能代码	名称	说明	设定范围	默认
Pb.03	电机过载保护电流	20.0%~120.0% (电机额定电流)	20.0~120.0	100.00%
Pb.04	门限电压	70.0.0~110.0% (标准母线电压)	70.0~110.0	80.00%
Pb.05	减少自由脱扣率	0.00~P0.03 (最大频率)	0.00~P0.03	0.00Hz/s
Pb.06	过电压失速保护	0: 禁用 1: 启用	0~1	1
Pb.07	过电压失速保护点	110~150%	110~150	120%
Pb.08	自动限流	50~200%	50~200	G 模型: 150.00% P 模型: 160.00%
Pb.09	频率下降率时, 限流	0.00~100.00Hz /s	0.00~100.0	10.00Hz/s
Pb.10	自动限流的选择	0: 启用 1: 禁用时, 定速	0~1	0

功能代码	名称	说明	设定范围	默认
Pb.11	选择的转矩 (OL3)	0：未检测 1：有效检测过力矩的 行驶时， 则继续 赛跑 2：有效检测过力矩的 在运行过 程中，则警告 停止 3：有效检测过力矩的 恒速运行 时，然后继续运行 4：有效检测过力矩的 恒速运行 时，然后报警并停止	0~4	1
Pb.12	的转矩检测水平	10.0%~200.0% (相对于所述电机的额定个当前)	1.0~200.0	G 模型 :150.0% P 模型 :120%
Pb.13	的转矩检测时间	0.1~60.0s	0.0~60.0	0.1s
Pb.14	保留的			
Pb.15	保留的			
<b>PC组：串行通信</b>				
PC.00	本地地址	0~247，0表示 广播地址	0~247	1

功能代码	名称	说明	设定范围	默认
PC.01	波特率选择	0: 1200BPS 1: 2400BPS 2: 4800BPS 3: 9600BPS 4: 19200BPS 5: 38400BPS	0~5	4
PC.02	数据格式	0 : RTU, 1个起始位, 8个数据位 无奇偶校验, 1个停止位 1 : RTU, 1个起始位, 8个数据位, 偶校验, 1个停止位 2 : RTU, 1个起始位, 8个数据位, 奇校验, 1个停止位 3 : RTU, 1个起始位, 8个数据位, 无奇偶校验, 2个停止位 4 : RTU, 1个起始位, 8个数据位, 偶校验, 2个停止位 5 : RTU, 1个起始位, 8个数据位, 奇校验, 2个停止位	0~5	1
PC.03	传播延迟 时间	0~200毫秒	0~200	5ms
PC.04	通信超时 延迟	0.0 : 禁用 0.0~100.0s选择	0.0~100.0	0.0s
PC.05	通讯错误 动作	0 : 报警并自由停车 1 : 不报警并继续运行 2 : 不报警, 但停止	0~3	1



功能代码	名称	说明	设定范围	默认
		根据P1.06 ( 如果P0.03= 2 ) 3 : 不报警 , 但根据停 为P1.06		
PC.06	响应行动	LED的Unit`s地方 0 : 回应写作 1 : 不回应写Ten`s LED个位  0 : 引用时不被保存 没电了  1 : 参考保存时没电了	00~11	0

**PD组 : 补充作用**

**PE组出厂设置**

## 8-故障检修

故障信息，以及可能的原因和纠正措施。本章介绍了如何复位故障和查看

故障记录.它还列出了所有报警

### 8.1故障及故障排除

故障代码	故障类型	原因	解决方案
Out1	IGBT故障	1.加速时间过短 2. IGBT模块故障 3.错误所造成的干扰 4.接地是没有正确	1.增加加速时间。 2.要求支持。 3.检查外部设备，排除干扰
OC1	过电流时的加速度	1.加速时间过短。 2.电网的电压太低。 3.变频器的功率过低。	1.增加加速时间。 2.检查输入电源 3.选择更大容量的变频器。
OC2	过电流时减速	1.减速时间太短 2.负载惯量的转矩大 3.变频器的功率过低	1.增加减速时间。 2.安装适当的能量消费制动组件 3.选择更大容量的变频器
OC3	过电流恒速运行时	1负载瞬变或异常 2.负载的惯性大 3.输入电压异常	1.检查负载或减小负载的瞬态 2.检查输入电源 3.选择更大容量的变频器。
OV1	过电压时	1.输入电压为异常	1.检查输入电源

故障代码	故障类型	原因	解决方案
	促进	2.重新启动后突然断电运行的电机。	2.避免重启向上停药后
OV2	过电压时，减速	1.减速时间太短。 2.负载的惯性大。 3.输入电压异常	1.增加减速时间 2.增加的耗能组件 3.检查输入电源
OV3	过压恒速运行时，	1.输入电压变化异常。 2.负载的惯性大。	1.安装输入电抗器 2.增加的能量消耗成分
UV	直流母线欠压	1.电网的电压是低	1.检查电网的输入电源
OL1	电机过载	1.电源的电压是 2.电机设定的额定电流不正确 3.电机堵转或负载瞬态过强 4.电机功率过大	1.检查电源线的电源 2.复位电机的额定电流 3.检查负载，并调整扭矩电梯 4.选择合适的电机。
OL2	变频器过载超载	1.加速太快 2.复位旋转电机 3.将电源的电压太低 4.负载过大	1.增加加速时间 2.，停车后应避免重新启动。 3.检查电源线的电源 4.选择一个逆变器功率较大

故障代码	故障类型	原因	解决方案
SPI	输入缺相	缺相或输入波动 R,S,T	1.检查输入电源 2.检查安装分布
SPO	输出缺相	U , V , W缺相输入 ( 或严重不对称的三相负载 )	1.检查输出分布 2.检查电机和电缆
OH1	整顿IGBT 过热	1.变频器的过电流突然  2.有输出三相之间的直接或间接的短路  3.风道堵塞或风扇损坏  4.环境温度过高	1.参考过流解决方案  2.重新分配  3.疏通风道或改变风扇  4.低环境温度
OH2	逆变器 IGBT过热	5.控制面板或插件的接线松动  6.辅助电源损坏，驱动电压欠压  7.电源模块的桥臂接通  8.控制板异常1.参见过流解决方案	5.检查和重新连接  6.寻求技术支持  7.寻求技术支持  8.寻求技术支持
EF	外部故障	S1：外部故障输入端子生效	1.检查外部设备输入

故障代码	故障类型	原因	解决方案
CE	通信	1.波特率设置不正确 2.通信故障	1.设置适当的波特率 2.按STOP/RST复寻求帮助位和 3.检查通信连接分配
ItE	电流检测故障	3.通信关闭很长一段时间 1.控制电路板的连接不是好助手功率是坏 2.辅助电源损坏 3.霍尔元件坏了 4.改性电路异常	1.检查并重新连接 2.询问服务 3.寻求技术支持 4.寻求技术支持
tE	自整定故障	1.电机容量不符合逆变器能力 2.电机的额定参数	1.更改变频器型号 2.根据电机的铭牌设置等级参数
EEP	EEPROM故障	1.错误控制写和读的参数 2.损害EEPROM	1.按 STOP/ RST复位 2.询问服务
PIDE	PID反馈故障	1. PID反馈离线 2. PID反馈源消失	1.检查PID反馈信号线 2.检查PID反馈源

故障代码	故障类型	原因	解决方案
bE	制动单元故障	1.制动电路故障或损坏制动管 2.外部制动制制是有点低	1.检查制动单元，并更换新的制动管 2.增加制动电阻
END	出厂设定的时间范围	1.试用时代的到来	1.询问服务
OL3	过转矩	1.加速太快 2.复位旋转电机 3.将电源的电压太低 4.负载过大	1.增加加速时间 2，停车后应避免重新启动。 3，检查供应线路的功率 4.选择一个逆变器功率较大 5.调整PB.11为适当的值



NO.39 ,Lin Hai Road ,HaiGuan Town ,NiCheng  
Pudong New Area, Shanghai, CHINA.

上海市浦东新区泥城镇海关村临海路39号

Distributor
-------------

Ver:1.2

2014.11

[www.tetaelectric.com](http://www.tetaelectric.com)

---

This manual may be modified when necessary because of improvement of the product, modification, or changes in specifications, this manual is subject to change without notice