



**Microprocessor Controlled
I G B T Drive
Inverter Motor Speed Regulator
Operating Manual**

L510 Series	100V class	0.2~0.75KW (0.53~1.6KVA)
	200V class	0.2~2.2KW (0.53~4.0KVA)





TECO Electric & Machinery Co., Ltd

Add: 10F., No. 3-1, Yuancyu St., Nangang District

Taipei City 115, Taiwan

Tel: +886-2-6615-9111 Ext : 1721

Fax: +886-2-6615-0933

[Http://www.teco.com.tw](http://www.teco.com.tw)

Distributor

VER: 01 2010.8

This manual may be modified when necessary because of improvement of the product, modification, or changes in specification, this manual is subject to change without notice.

L510	Table of Contents	
Chapter 0	Preface	0-1
0.1	Preface	0-1
Chapter 1	Safety Precautions	1-1
	1.1 Before Power UP	1-1
	1.2 During Power UP	1-2
	1.3 Before Operation	1-2
	1.4 During Operation	1-3
	1.5 During Maintenance	1-3
Chapter 2	Definition of Model	2-1
Chapter 3	Ambient Environment and Installation	3-1
3.1	Environment	3-1
3.2	Installation	3-2
	3.2.1 Installation	3-2
	3.2.2 Installation Space	3-4
3.3	Wiring Rules	3-6
	3.3.1 Wiring guidelines	3-6
	3.3.2 Precautions for peripheral applications	3-7
3.4	Specifications	3-10
	3.4.1 Product Specifications	3-10
	3.4.2 General Specifications	3-11
3.5	Standard wiring	3-13
3.6	Terminal Description	3-16
	3.6.1 Description of main circuit terminals	3-16
	3.6.2 Control circuit terminal description	3-16
3.7	Outline Dimensions	3-17
Chapter 4	Software Index	4-1
4.1	Keypad Description	4-1
	4.1.1 Panel Function	4-1
	4.1.2 Show Description	4-2
	4.1.3 Function structure of LED digital tube displaying	4-4
	4.1.4 Example of keypad operation	4-5
	4.1.5 Operation Control	4-7
4.2	Programmable Functions List	4-8
4.3	Parameter Function Description	4-13
Chapter 5	Troubleshooting and Maintenance	5-1
5.1	Error Display and Corrective Action	5-1
	5.1.1 Manual Reset and Auto-Reset	5-1
	5.1.2 Keypad Operation Error Instruction	5-2
	5.1.3 Special conditions	5-3
5.2	General troubleshooting	5-4
5.3	Troubleshooting of INV	5-5
	5.3.1 Quick troubleshooting of INV	5-5
	5.3.2 Troubleshooting for OC, OL error displays	5-7

	5.3.3 Troubleshooting for OV, LV error	5-8
	5.3.4 The motor can not run	5-9
	5.3.5 Motor Overheating	5-10
	5.3.6 Motor runs unevenly	5-10
5.4	Routine and periodic inspection	5-11
5.5	Maintenance and Inspection	5-12
Chapter 6	Peripheral Components	6-1
6.1	Reactor Specifications	6-1
6.2	Electromagnetic Contactor and No fuse circuit breaker	6-1
6.3	Fuse Specification	6-1
Appendix I	L510 Parameters Setting List	App1-1

Chapter0 Preface

0.1 Preface

To extend the performance of the product and ensure personnel safety, please read this manual thoroughly before using the inverter. Should there be any problem in using the product that cannot be solved with the information provided in the manual, contact Our's technical or sales representative who will be willing to help you.

※Precautions

The inverter is an electrical product. For your safety, there are symbols such as “Danger”, “Caution” in this manual as a reminder to pay attention to safety instructions on handling, installing, operating, and checking the inverter. Be sure to follow the instructions for highest safety.

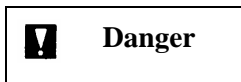

Indicates a potential hazard that could cause death or serious personal injury if misused.

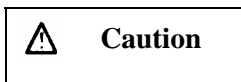

Indicates that the inverter or the mechanical system might be damaged if misused.

Danger

- ✓ Do not make any connections when the inverter is powered on. Do not check parts and signals on circuit boards during the inverter operation.
- ✓ Do not disassemble the inverter or modify any internal wires, circuits, or parts.
Ground the ground terminal of the inverter properly.

Caution

- ✓ Do not perform a voltage test on parts inside the inverter. High voltage can destroy the semiconductor components.
- ✓ Do not connect T1, T2, and T3 terminals of the inverter to any AC input power supply.
- ✓ CMOS ICs on the inverter's main board are susceptible to static electricity. Do not touch the main circuit board.

Chapter 1 Safety Precautions

1.1 Before Power Up

Caution

- ✓ The line voltage applied must comply with the inverter's specified input voltage.(See product nameplate)

Danger

- ✓ Make sure the main circuit connections are correct Single phase(L1,L2)/Three phase(L1,L2,L3) are power-input terminals and must not be mistaken for T1, T2 and T3. Otherwise, inverter damage can result.

Caution

- ✓ To avoid the risk of fire, do not install the inverter on flammable objects. Install on nonflammable objects such as metal surfaces.
- ✓ If several inverters are placed in the same control panel, provide heat extraction means to keep the temperature below 40°C to avoid overheating or fire hazard.

Warning

- ✓ This product is sold subject to **IEC 61800-3**. In a domestic environment this product may cause radio interference in which case the user may be required to apply corrective measures.

1.2 During Power Up

Danger

- ✓ When momentary power loss is longer than 2 seconds (the larger of horse power, the longer of time), the inverter does not have enough storage power to control the circuit; Therefore, when the power is re-applied, the operation of the inverter is based on the setup of 00-02(or00-03) /07-04 and the condition of external switch, this is considered to be 「restart」 in the following paragraphs.
- ✓ When the momentary power loss is short, the inverter still has enough storage power to control the circuit. Therefore, when power is re-applied, the inverter will automatically restart depending on the setup of 07-00.
- ✓ When restarting the inverter, the operation of the inverter is based on the setup of 00-02(or00-03) and 07-04 and the condition of external switch (FWD/REV button). Attention: the start operation will be regardless of 07-00/07-01/07-02:
 1. When 00-02(or00-03) =0, the inverter will not automatically run after restart.
 2. When 00-02(or00-03) =1 and the external switch (FWD/REV button) is OFF, the inverter will not run after restart.
 3. When 00-02(or00-03) =1, the external switch (FWD/REV button) is ON, and 04-09=0, the inverter will run automatically after restart.Attention: To ensure safety, please turn off the external switch (FWD/REV button) after power loss, to protect machines from possible damage and potential injury to personnel on sudden resumption of power.
- ✓ If 07-04 is set to 0 (direct start up), please refer to the description and warnings for 07-04 to verify the safety of operator and machine.

1.3 Before Operation

Danger

- ✓ Make sure the model and inverter capacity are the same as that set in parameter 13-00.

Caution

- ✓ On power up the supply voltage set in parameter 01-01 will flash on display for 2 seconds.

1.4 During Operation

Danger

- ✓ Do not connect or disconnect the motor during operation. Otherwise, the over-current will cause the inverter to trip or damage the unit.

Danger

- ✓ The motor will restart automatically after stop when auto-restart function is on. In this case, use caution while working near the drive, motor, or driven equipment.

Caution

- ✓ Do not touch heat-generating components such as heat sinks.
- ✓ The inverter can drive the motor from low speed to high speed. Verify the allowable speed range of the motor and the load before operation.
- ✓ Do not check signals on circuit boards while the inverter is running.

Caution

- ✓ Make sure the power is off before disassembling or checking the components

1.5 During Maintenance

Caution

- ✓ The Inverter can be used in environment in temperature range from 14°-104°F (-10-40°C) and relative humidity of 95%.

Inverter Disposal

Caution

Please dispose of this unit with care as an industrial waste and according to your required local regulations.

- ✓ The capacitors of inverter main circuit and printed circuit board are considered as hazardous waste and must not be burnt.
- ✓ The Plastic enclosure and parts of the inverter such as the cover board will release harmful gases if burnt.

Chapter 2 Definition of mode

2.1 Model

L510 - 1 P2 - H 1 - N

Supply voltage
1: 100V Class
2: 200V Class

Horsepower
100V Class P2: 0.25 HP
P5: 0.5 HP
01: 0.75 HP
200V Class P2: 0.25 HP
P5: 0.5 HP
01: 1 HP
02: 2 HP
03: 3 HP

P: PNP
N: NPN

filter F : Built-in
Blank: None

Power supply
1: Single phase
3: Three phase

Specification
H: Standard Type

Model	Supply voltage (Vac)	Frequency (Hz)	(Hp)	(KW)	Model		VR Built-in	Filter	
					NPN	PNP		Built-in	None
L510-1P2-H1-N	1ph, 100~120V 10%/-15%	50/60Hz	0.25	0.2	✓		✓		✓
L510-1P5-H1-N			0.5	0.4	✓		✓		✓
L510-101-H1-N			1	0.75	✓		✓		✓
L510-2P2-H1F-P	1ph, 200~240V +10%/-15%		0.25	0.2		✓		✓	
L510-2P5-H1F-P			0.5	0.4		✓		✓	
L510-201-H1F-P			1	0.75		✓		✓	
L510-202-H1F-P			2	1.5		✓		✓	
L510-203-H1F-P			3	2.2		✓		✓	
L510-2P2-H1-N			0.25	0.2	✓		✓		✓
L510-2P5-H1-N			0.5	0.4	✓		✓		✓
L510-201-H1-N			1	0.75	✓		✓		✓
L510-202-H1-N			2	1.5	✓		✓		✓
L510-203-H1-N	3		2.2	✓		✓		✓	
L510-2P2-H3-N	3ph, 200~240V +10%/-15%		0.25	0.2	✓		✓		✓
L510-2P5-H3-N			0.5	0.4	✓		✓		✓
L510-201-H3-N		1	0.75	✓		✓		✓	
L510-202-H3-N		2	1.5	✓		✓		✓	
L510-203-H3-N		3	2.2	✓		✓		✓	

Chapter 3 Ambient Environment and Installation

3.1 Environment

The environment will directly affect the proper operation and the life span of the inverter, so install the inverter in an environment complying with the following conditions:

Protection	
Protection class	IP20
Suitable environment	
Operating temperature	-10~50°C If several inverters are installed in the same control panel, please make sure the placement is conductively to vent heat.
Storage temperature	-20~60°C
Humidity	95% RH or less (no condensation) Notice prevention of inverter freezing up.
Shock	20Hz Below 1G (9.8m/s²) 20~50Hz 0.6G (5.88m/s²)
Installation sites	
Avoid direct sunlight.	
Avoid exposure to rain or moisture.	
Avoid oil mist and salinity.	
Avoid corrosive liquid and gas.	
Avoid dust, lint fibers, and small metal filings.	
Avoid electromagnetic interference (soldering machine, power machine).	
Keep away from radioactive and flammable materials.	
Avoid vibration (stamping, punching machine). Add a vibration-proof pad if the situation cannot be avoided.	

Exterior

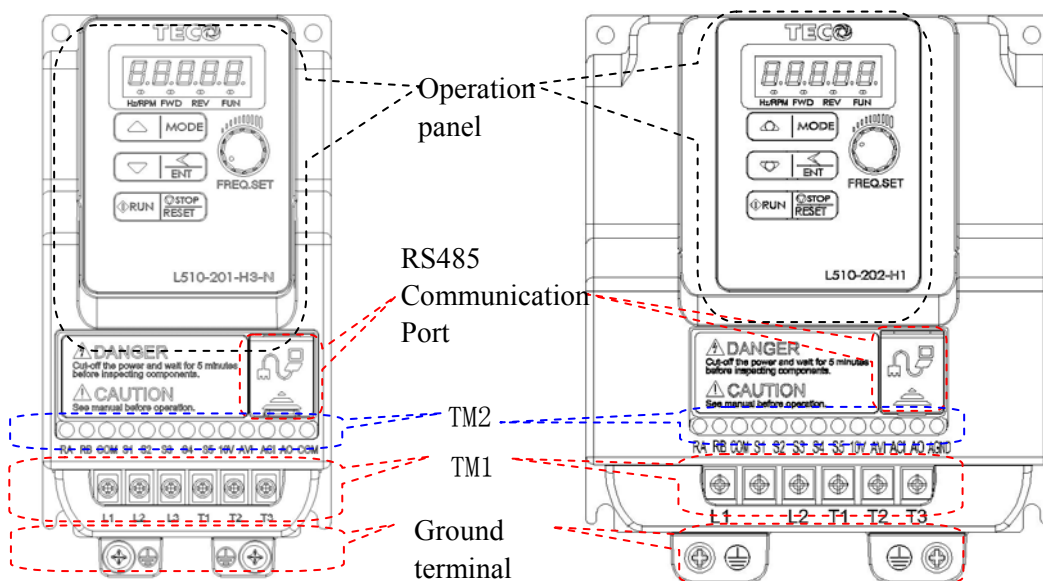

3.2 Installation

3.2.1 Installation

Frame1

Standard installation:

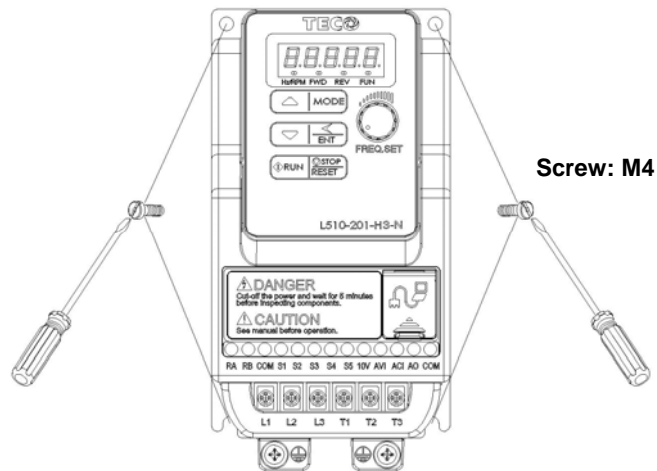

Plastic pedestal:

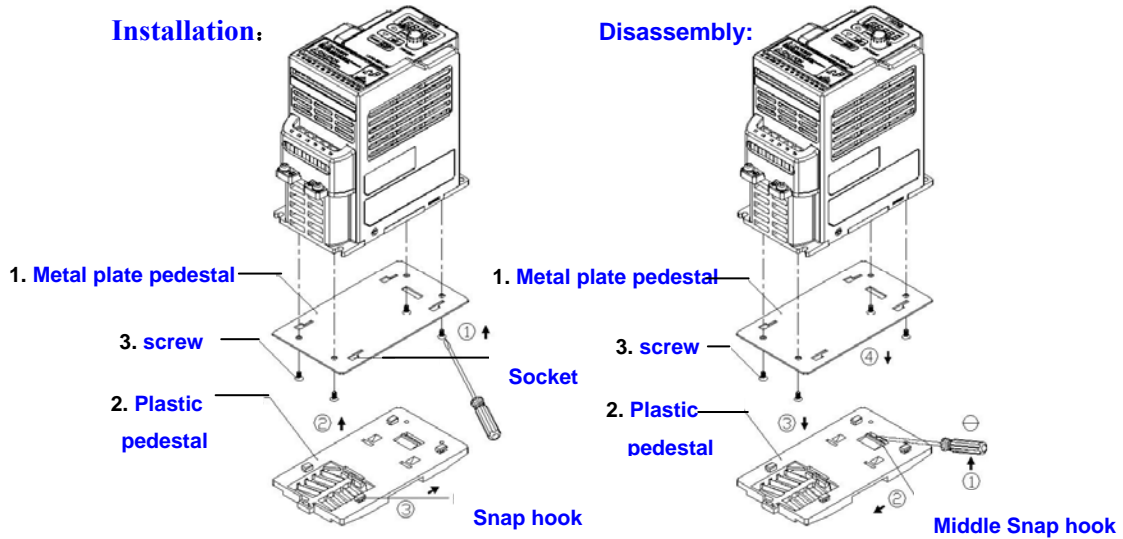

Guide strip:

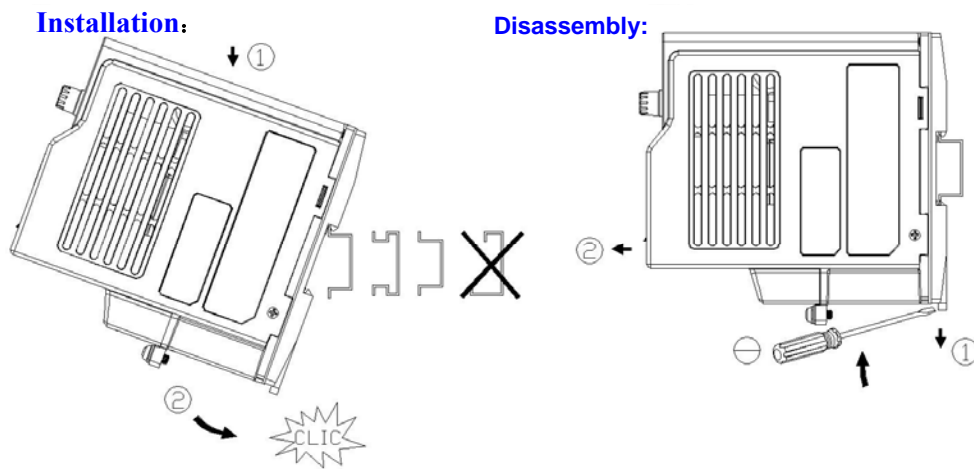

Note:

- Frame2: Optional Fitting :**
1. Metal plate pedestal (4KA76X414T01)
 2. Plastic pedestal (4KA82X442T01)
 3. Chamfer head screw: M3×6

Frame2

Standard installation:

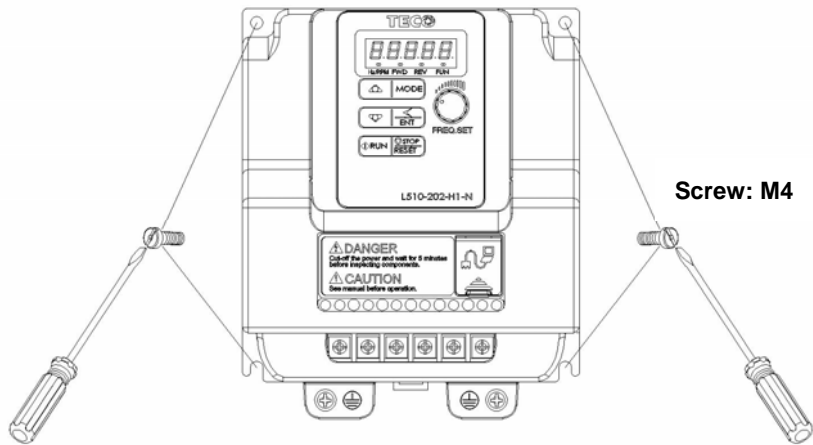

Plastic pedestal:

Installation:

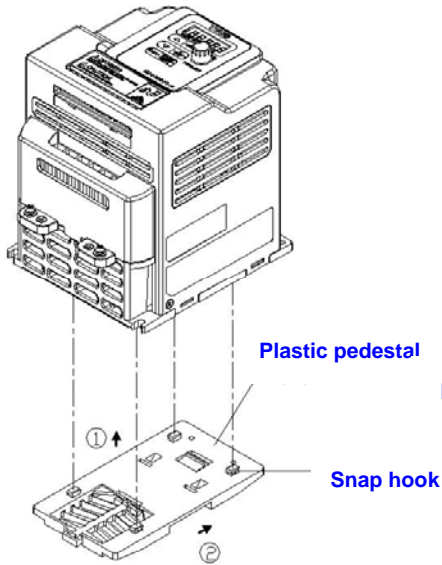

Disassembly:

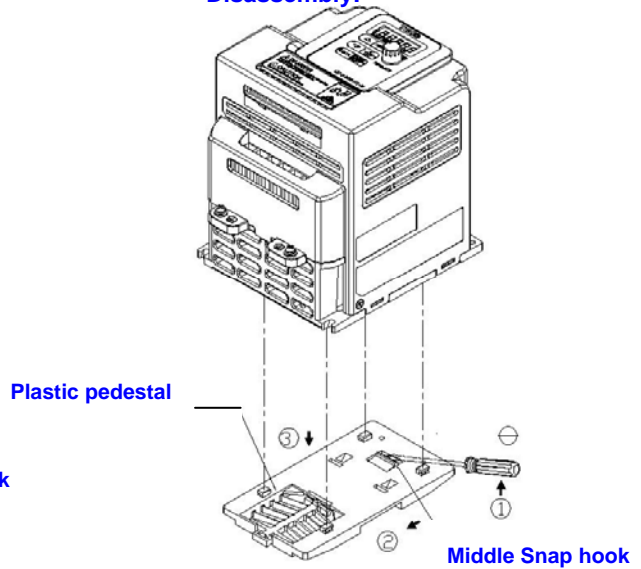

Guide strip:

Installation:

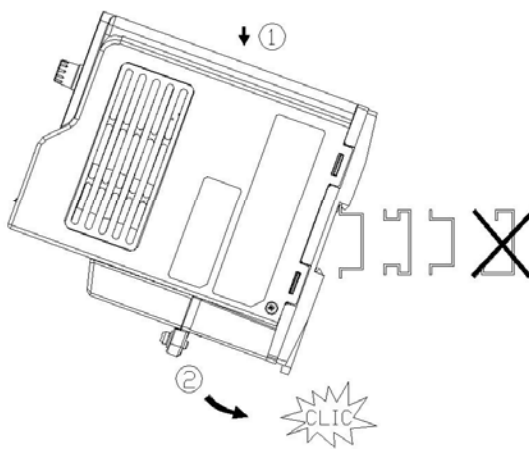

Disassembly:

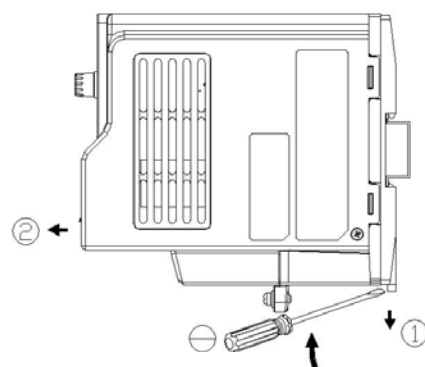

Note: Frame2: Optional Fitting :Plastic pedestal (4KA82X442T01)

3.2.2 Installation Space

Please notice that enough air circulation space for cooling inverters should be insured when installation.

Single Installation

In order to ensure good cooling effect, be sure to install the transducer vertical.

Frame1

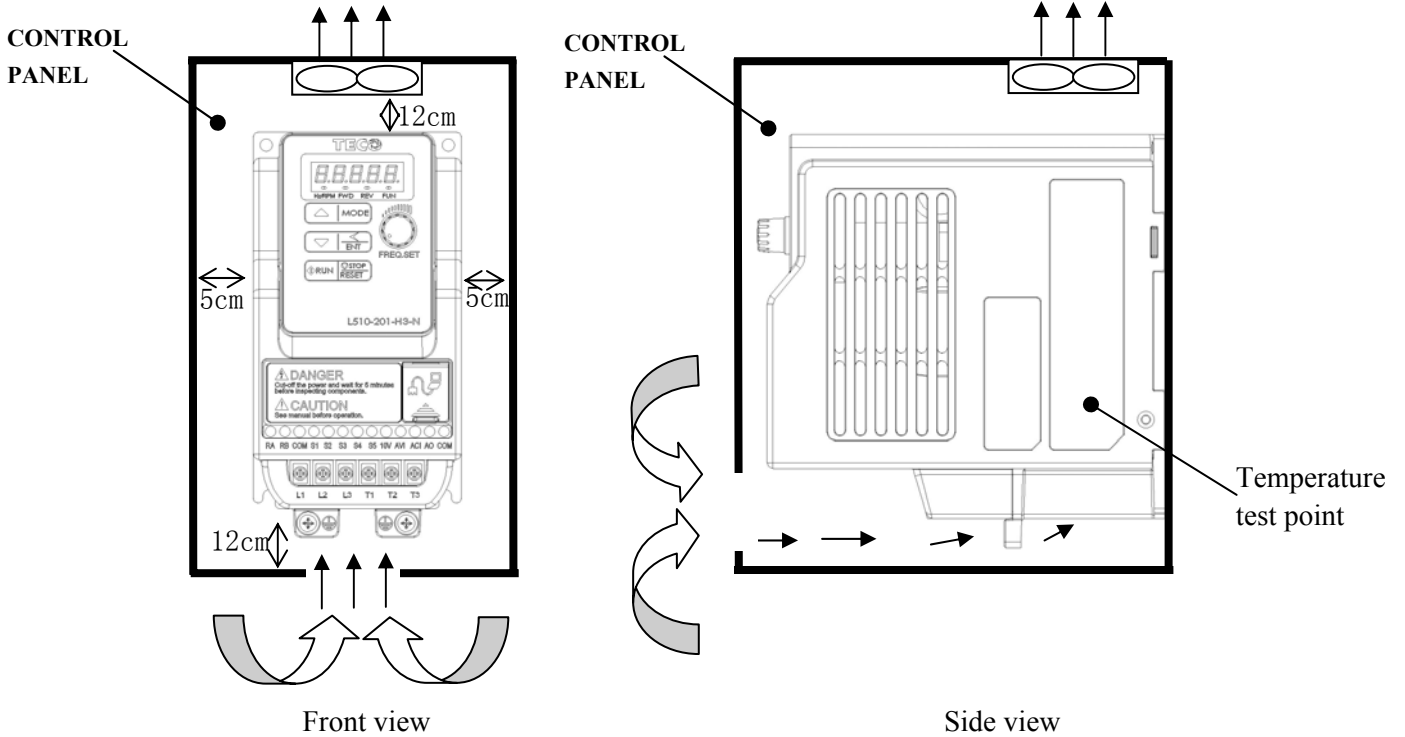

Frame2

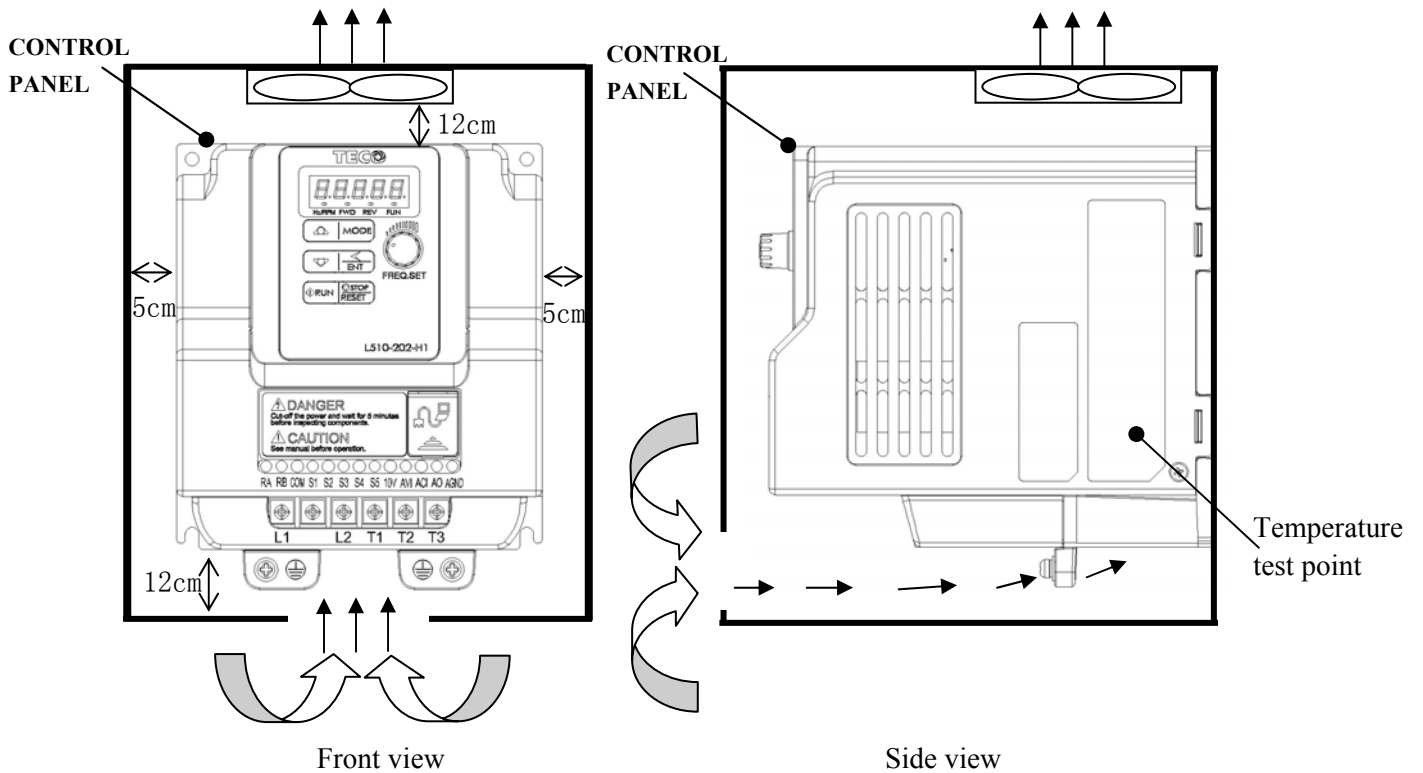

Note: “  means Fan.

Installation of multiple parallel

Installing multiple inverters parallel, install as the following icon to ensure the cooling effect.

Frame1

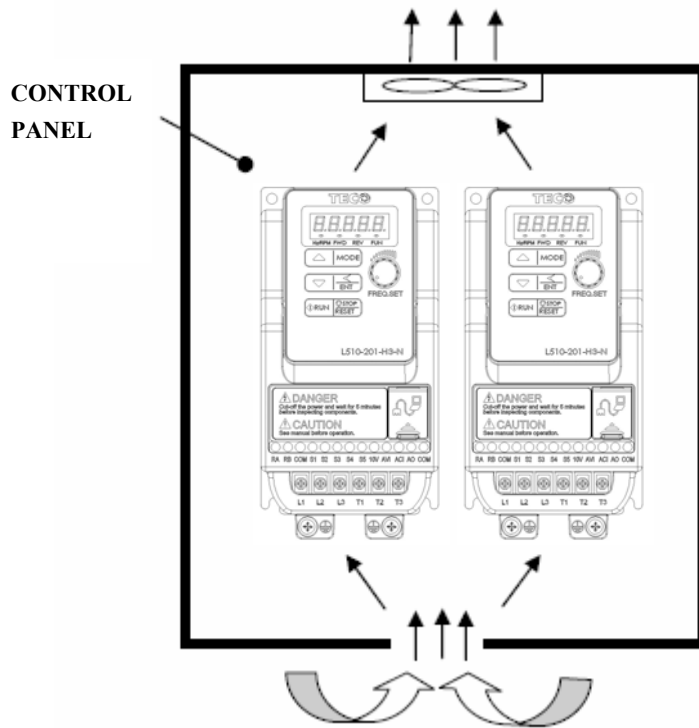

Frame2

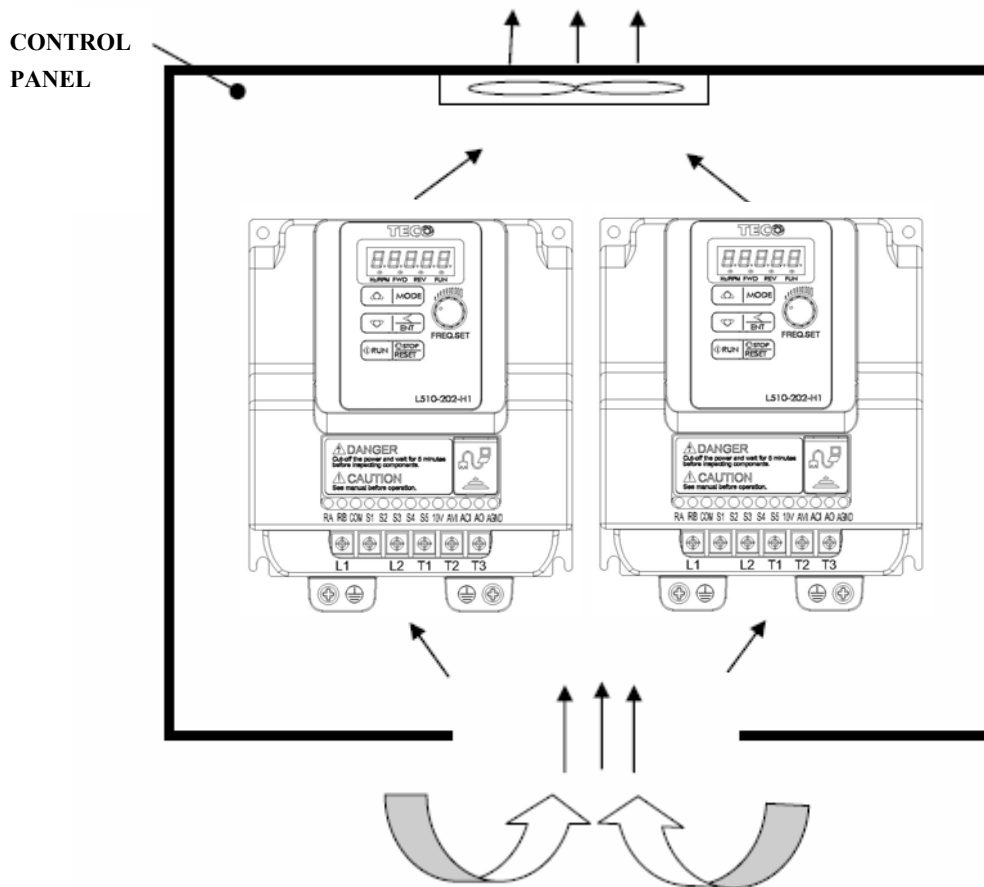

3.3 Wiring Rules

3.3.1 Wiring guidelines

(1) **Tightening torque:** Required Screwdriver Torques are as listed 3-1:

(2) **Power Cables :**

Power cables are connected to TM1 terminal block, terminals L1, L2, L3, T1, T2, T3, Choose power cables according to the following criteria:

- Use copper wires only. Correct wire diameters should be based on ratings at 105oC.
- For rating voltage of wires, the minimum voltage of 200V class type is 300V.
- To ensure safety, power cord should be locked with O-pin.

(3) **Control Cables:** Control cables are connected to TM2 control terminal block. Choose control cables according to the following criteria:

- Use copper wires only. Correct wire diameters should be based on ratings at 105oC.
- For rating voltage of wires, the minimum voltage of 200V class type is 300V.
- To avoid noise interference, do not route power and control cables in the same conduit or trucking.







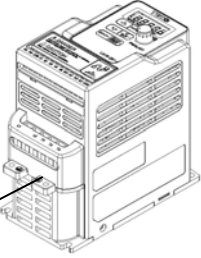

Chart 3-1

Model	TM1		TM2	
	AWG	Tightening torque	AWG	Tightening torque
Frame1	22~10AWG	14Kgf.cm	2.5mm ²	M2.5 4.08Kgf.cm
Frame2	22~10AWG	12.24Kgf.cm	24~12AWG	

(4) **Notes:**

- Teco bears no responsibility to service for failures caused by the following conditions:
 - ✧ A molded-case circuit breaker is not installed, or an improper or overrated breaker is used, between the power source and the inverter.
 - ✧ A magnetic contactor, a phase capacitor, or a burst absorber is connected between the inverter and the motor.
- Use three-phase squirrel cage induction motor with capacity suitable for the inverter.
- If one inverter is driving several motors, the total current of all motors running simultaneously must be less than the rated current of the inverter, and each motor has to be equipped with a proper thermal relay.
- Do not add capacitive components, such as a phase capacitors, LC or RC, between the inverter and the motor.

3.3.2 Precautions for peripheral applications peripheral equipment

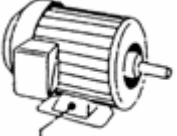
	Power	<ul style="list-style-type: none"> ➤ Make sure the correct voltage is applied to avoid damaging the inverter. ➤ A molded-case circuit breaker or fused disconnect must be installed between the AC source and the inverter
 	Molded-case circuit breaker and Leakage breaker	<ul style="list-style-type: none"> ➤ Use a molded-case circuit breaker that conforms to the rated voltage and current of the inverter to control the power ON/OFF and protect the inverter. ➤ Do not use the circuit breaker as the run/stop switch for the inverter. ➤ Setting current should be 200mA or above and the operating time at 0.1 second or longer to prevent malfunctions.
 	Magnetic contactor	<ul style="list-style-type: none"> ➤ Normal operations do not need a magnetic contactor. However a contactor has to be installed in primary side when performing functions such as external control and auto restart after power failure, or when using a brake controller. ➤ Do not use the magnetic contactor as the run/stop switch of the inverter.
	AC reactor for power quality improvement	<ul style="list-style-type: none"> ➤ When inverters below 200V/400V class 15KW are supplied with high capacity (above 600KVA) power source or an AC reactor can be connected to improve the power performance.
	Input noise filter	<ul style="list-style-type: none"> ➤ A filter must be installed when there are inductive loads affecting the inverter.
   接地	Inverter	<ul style="list-style-type: none"> ➤ Single phase Input power terminals L1, and L3(Three phase:L1,L2and L3) can be used in any sequence regardless of phase. ➤ To avoid damaging the inverter, do not connect the input terminals T1, T2, and T3 to AC input power. ➤ Output terminals T1, T2, and T3 are connected to U, V, and W terminals of the motor. If the motor is reversed while the inverter is set to run forward, just swap any two terminals of T1, T2, and T3. ➤ Connect the ground terminal properly.
 接地	Motor	<ul style="list-style-type: none"> ➤ Three-phase cage motor

Notes

Make external connections according to the following instruction. Check connections after wiring to make sure all connections are correct. (Do not use the control circuit buzzer to check connections)

(1) Main circuit's wiring must be separated from other high voltage or high current power line to avoid noise interference. Refer to the figures below:

- The inverter uses dedicated power line

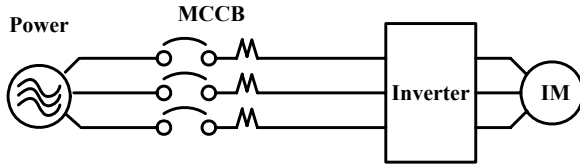

- Add a noise filter or separation transformer when sharing the power line with other machines, the inverter shares the power line with other machines.

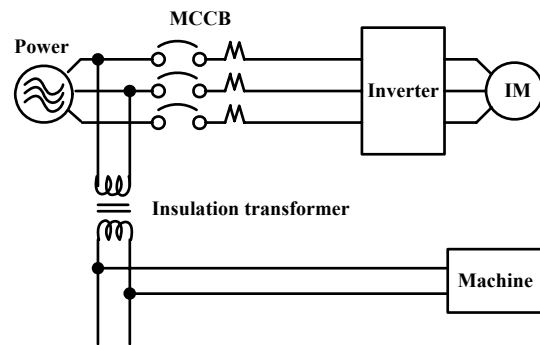
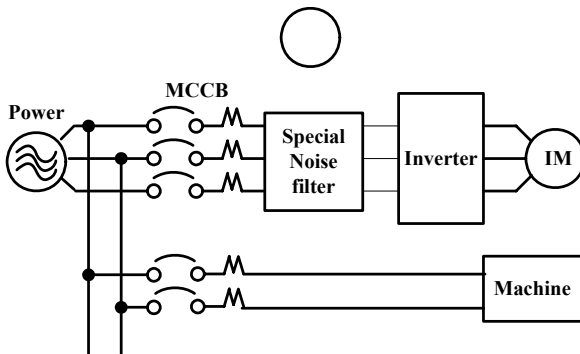

- A general noise filter may not provide correct results.

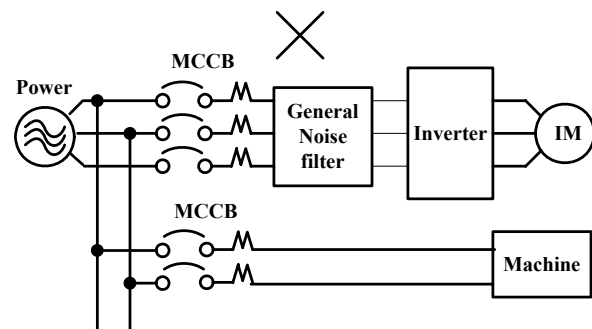
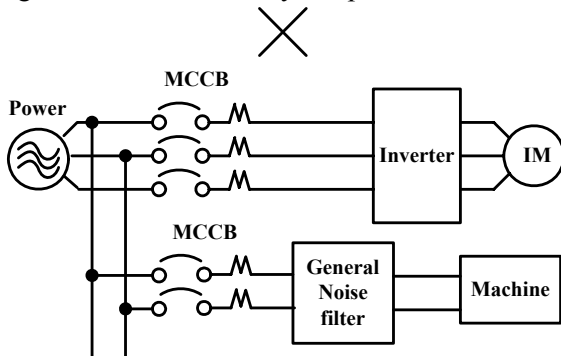

- To prevent radiated noise, the wires should be put in a metal pipe and distance from signal lines of other control equipment should be more than 30 cm.

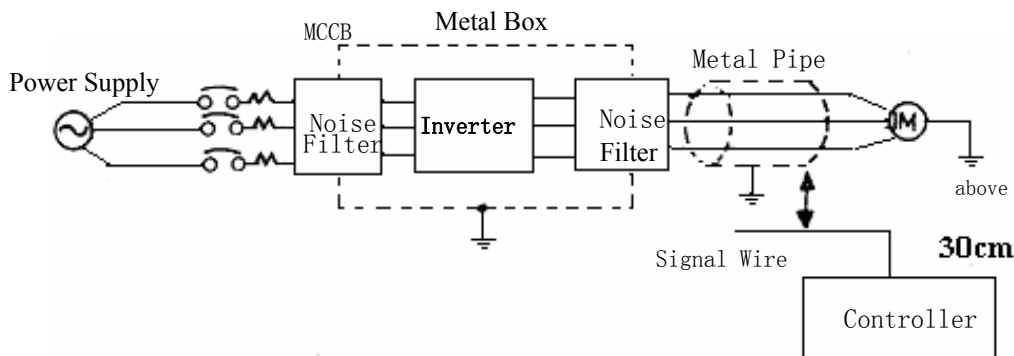

- When the connection between the inverter and the motor is too long, consider the voltage drop of the cables. Phase-to-phase voltage drop (V) = $\sqrt{3} \times \text{resistance of wire } (\Omega/\text{km}) \times \text{length of line (m)} \times \text{current} \times 10^{-3}$.

- (2) The control circuit wiring must be separated and routed away from the main circuit control line or other high voltage or current power lines to avoid noise interference.
- To avoid erroneous operation caused by noise interference, shield the control circuit wiring with twisted-wires, and connect the shielded wire to a ground terminal. Refer to the figure below. The wiring distance should not exceed 50 meters.

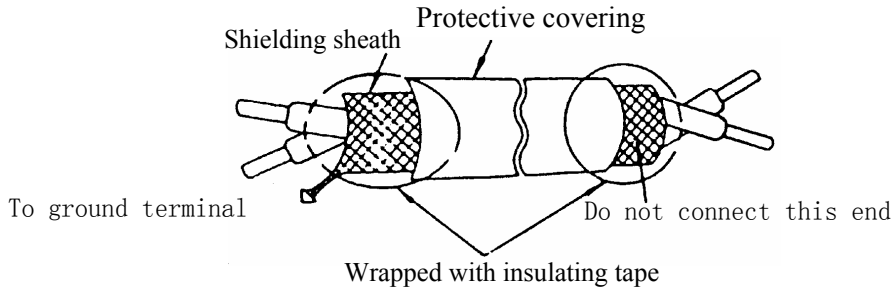

(3) Inverter Ground terminal must be connected to installation ground correctly and according to the required local wiring regulations.

- Ground cable size must be according to the required local wiring regulations. The shorter the better.
- Do not share the ground of the inverter with other high current loads (Welding machine, high power motor). Connect the terminals to their own ground.
- Do not make a loop when several inverters share a common ground point.

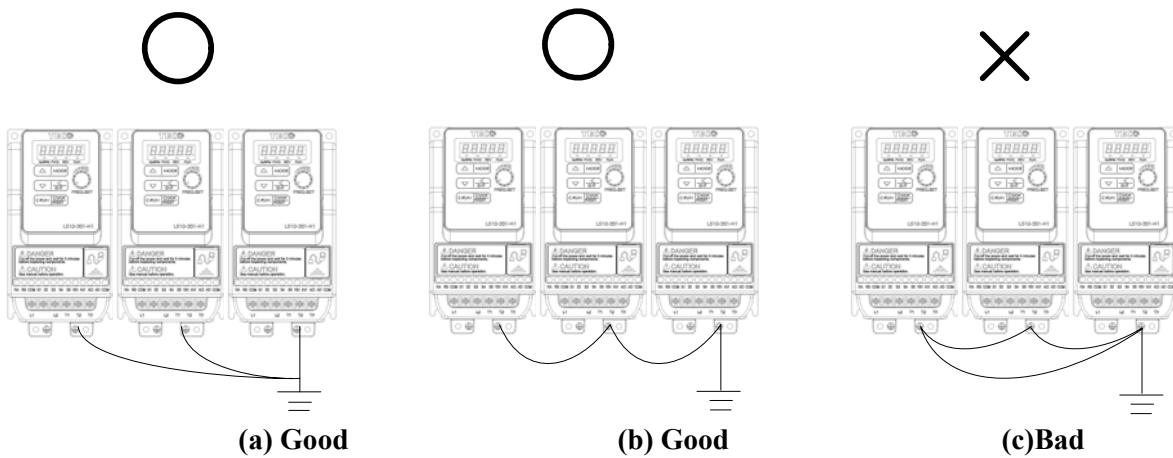

- (4) To ensure maximum safety, use correct wire size for the main power circuit and control circuit. (According to the required local regulations).
- (5) Verify that all wiring is correct, wires are intact, and terminal screws are secured.

3.4 Specifications

3.4.1 Product Specifications

110VClass: Single phase

Model: L510-□□□-H1-N	1P2	1P5	101
Horse power (HP)	0.25	0.5	1
Suitable motor capacity (KW)	0.2	0.4	0.75
Rated output current (A)	1.8	2.6	4.3
Rated capacity (KVA)	0.68	1.00	1.65
Input voltage range(V)	Single Phase: 100~120V(+10%-15%),50/60HZ		
Output voltage range(V)	Three phase 0~240V		
Input current (A)	9.5	13	19
Inverter N.W (KG)	0.62	0.68	0.72
Inverter with filter (KG)			
Allowable momentary power loss time (S)	1.0	1.0	1.0
Enclosure	IP20		

220VClass: Single phase

Model: L510-□□□-H1-N (L510-□□□-H1F-P)	2P2	2P5	201	202	203
Horse power (HP)	0.25	0.5	1	2	3
Suitable motor capacity (KW)	0.2	0.4	0.75	1.5	2.2
Rated output current (A)	1.8	2.6	4.3	7.5	10.5
Rated capacity (KVA)	0.68	1.00	1.65	2.90	4.00
Input voltage range(V)	Single Phase: 200~240V (+10%-15%),50/60HZ				
Output voltage range(V)	Three phase 0~240V				
Input current (A)	4.9	7.2	11	15.5	21
Inverter N.W (KG)	0.65	0.67	0.67	1	1.05
Inverter with filter (KG)	0.71	0.73	0.73	1.25	1.3
Allowable momentary power loss time (S)	1.0	1.0	1.0	2.0	2.0
Enclosure	IP20				

220VClass: Three phase

Model: L510-□□□-H3-N	2P2	2P5	201	202	203
Horse power (HP)	0.25	0.5	1	2	3
Suitable motor capacity (KW)	0.2	0.4	0.75	1.5	2.2
Rated output current (A)	1.8	2.6	4.3	7.5	10.5
Rated capacity (KVA)	0.68	1.00	1.65	2.90	4.00
Input voltage range(V)	Three phase : 200~240V (+10%-15%),50/60HZ				
Output voltage range(V)	Three phase 0~240V				
Input current (A)	3.0	4.0	6.4	9.4	12.2
Inverter N.W (KG)	0.61	0.61	0.66	0.95	1
Inverter with filter (KG)					
Allowable momentary power loss time (S)	1.0	1.0	1.0	2.0	2.0
Enclosure	IP20				

F: means built-in filter

3.4.2 General Specifications

Item	L510	
Control Mode	V/F Control +Auto-torque compensation function	
Frequency	Range	0.01~650.00Hz
	Setting resolution	Digital input: 0.01Hz
		Analog input: 0.06Hz/60Hz
	Setting	Keypad: Set directly with ▲ ▼ keys or the VR on the keypad
		External terminal: ·AVI(0~10V/2~10V)、ACI(0~20mA/4~20mA)input ·Multifunction input up/down function(Group3) Communication settings
Frequency limit	·The lower and upper limit of frequency ·3 jump frequency can be set	
Run	Operation set	Panel: run, stop button control
		external terminal: ·Multi- operation-mode2 / 3 wire selection ·JoG operation
		Communication operation
Commonly Control	V / F curve setting	6 fixed curve, an arbitrary curve
	Carrier frequency	1~16KHz
	Acceleration and deceleration control	<ul style="list-style-type: none"> • 2 Acc / dec time can be set • 4 S curve can be set
	Multifunction input	19 functions (refer to description on group3)
	Multifunction output	14 functions (refer to description on group3)
	Multifunction analog output	5 functions (refer to description on group3)
	Other features	Overload Detection, 8 preset speeds, Auto-run, Acc/Dec Switch (2 Stages), Main/Alt run Command select, Main/Alt Frequency Command select, PID control, torque boost, V/F start Frequency, abnormality reset and ect.
Display	LED	Display : parameter / parameter value / frequency / line speed / DC voltage / output voltage / output current / PID feedback / input and output terminal status / Heat sink temperature / Program Version / Fault Log and ect.
	Status Indicator	Instructions: run / stop / forward / reverse ,and etc.
Protective Functions	Overload Protection	The relays to protect the motor and the inverter.
	Over voltage	·110V/220V: >410V
	Under Voltage	·110V/220V: <190V
	Momentary Power Loss Restart	Inverter can auto-restart after power instantaneously loss.
	Stall Prevention	Stall prevention for Acceleration/ Deceleration/ Operation.
	Short-circuit output terminal	Electronic Circuit Protection
	Grounding Fault	Electronic Circuit Protection

	Other protection features	Protection for overheating of heat sink,The carrier frequency decreasing with the temperature function,fault output,reverse prohibit,prohibit for direct start after power up and error recovery ,parameter lock up
Communication control		Standard built-in RS485 communication (Modbus), One to one or One to many control.
Environment	Operating temperature	-10~50°C
	Storage temperature	-20~60°C
	Humidity	95% RH or less (no condensation)
	Shock	20Hz or less 1G(9.8m/s ²)20~50Hz 0.6G(5.88m/s ²)
	Protection class	IP20

3.5 Standard wiring

Single phrase(NPN):

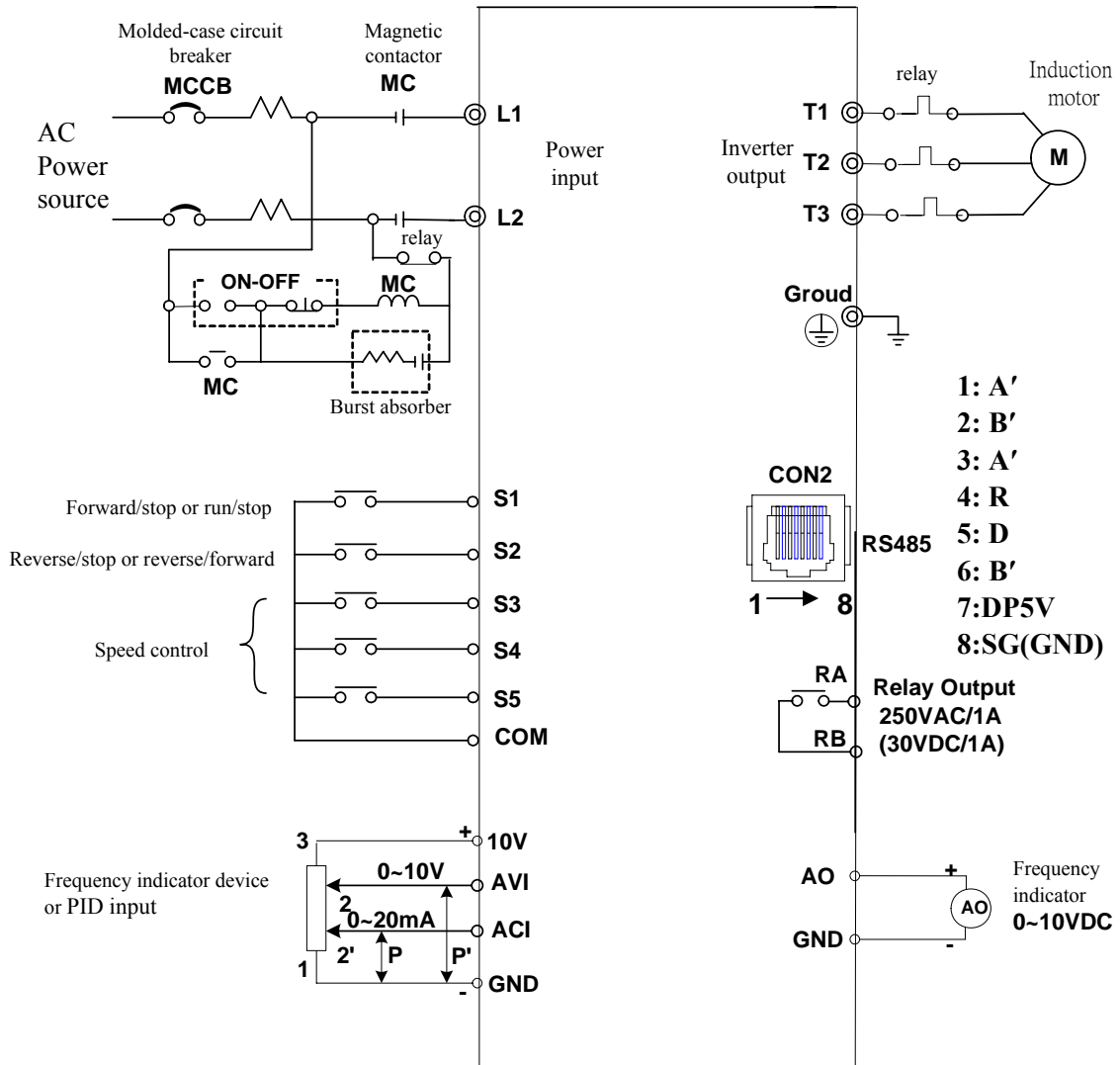

Model:

100V: L510-1P2-H1-N/ L510-1P5-H1-N / L510-101-H1-N

200V: L510-2P2-H1-N / L510-2P5-H1-N /

L510-201-H1-N /L510-202-H1-N /

L510-203-H1-N

Single phase(PNP):

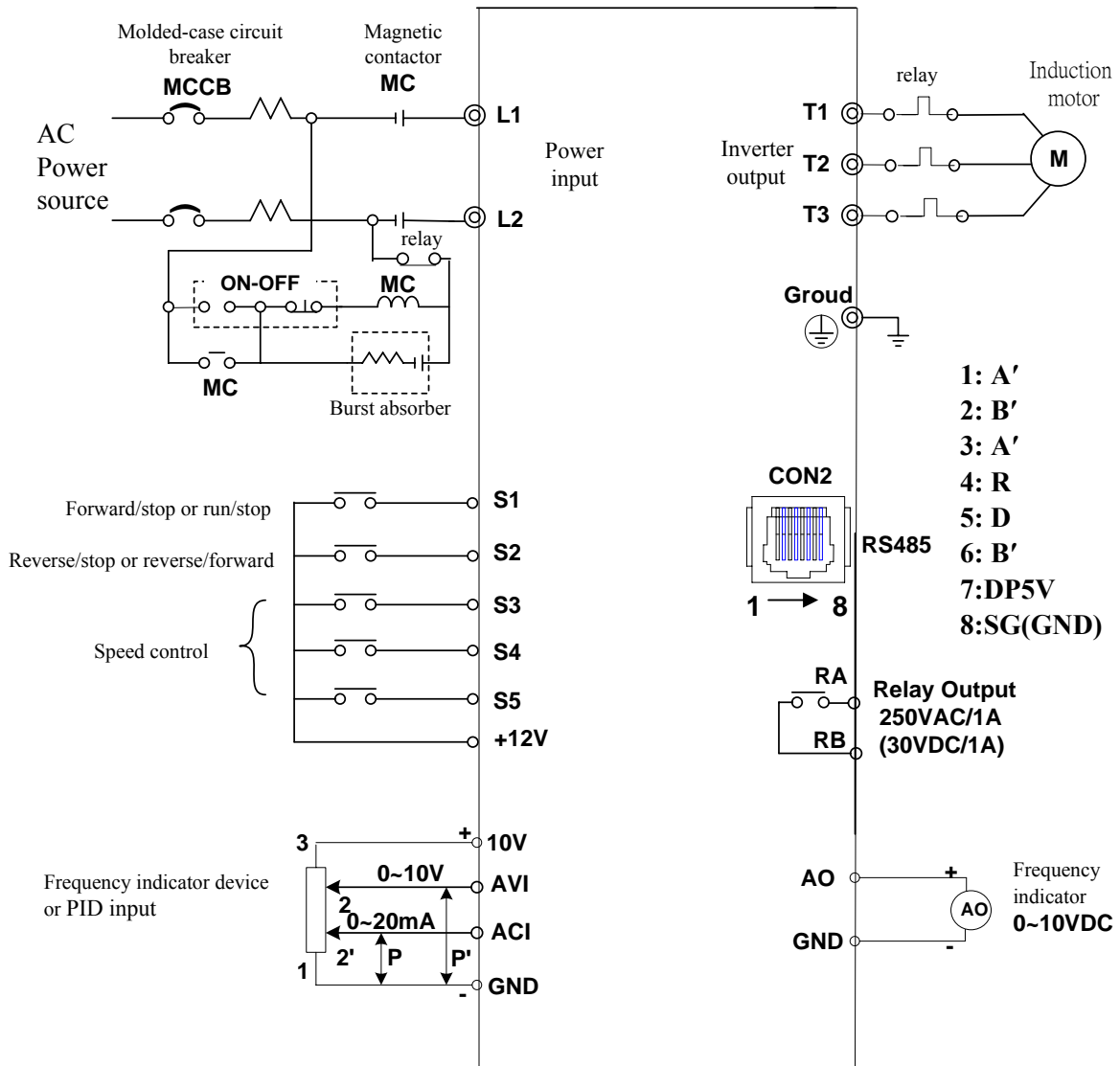

Model:

**200V: L510-2P2-H1F-P / L510-2P5-H1F-P /
L510-201-H1F-P /L510-202-H1F-P /
L510-203-H1F-P**

Three phase:

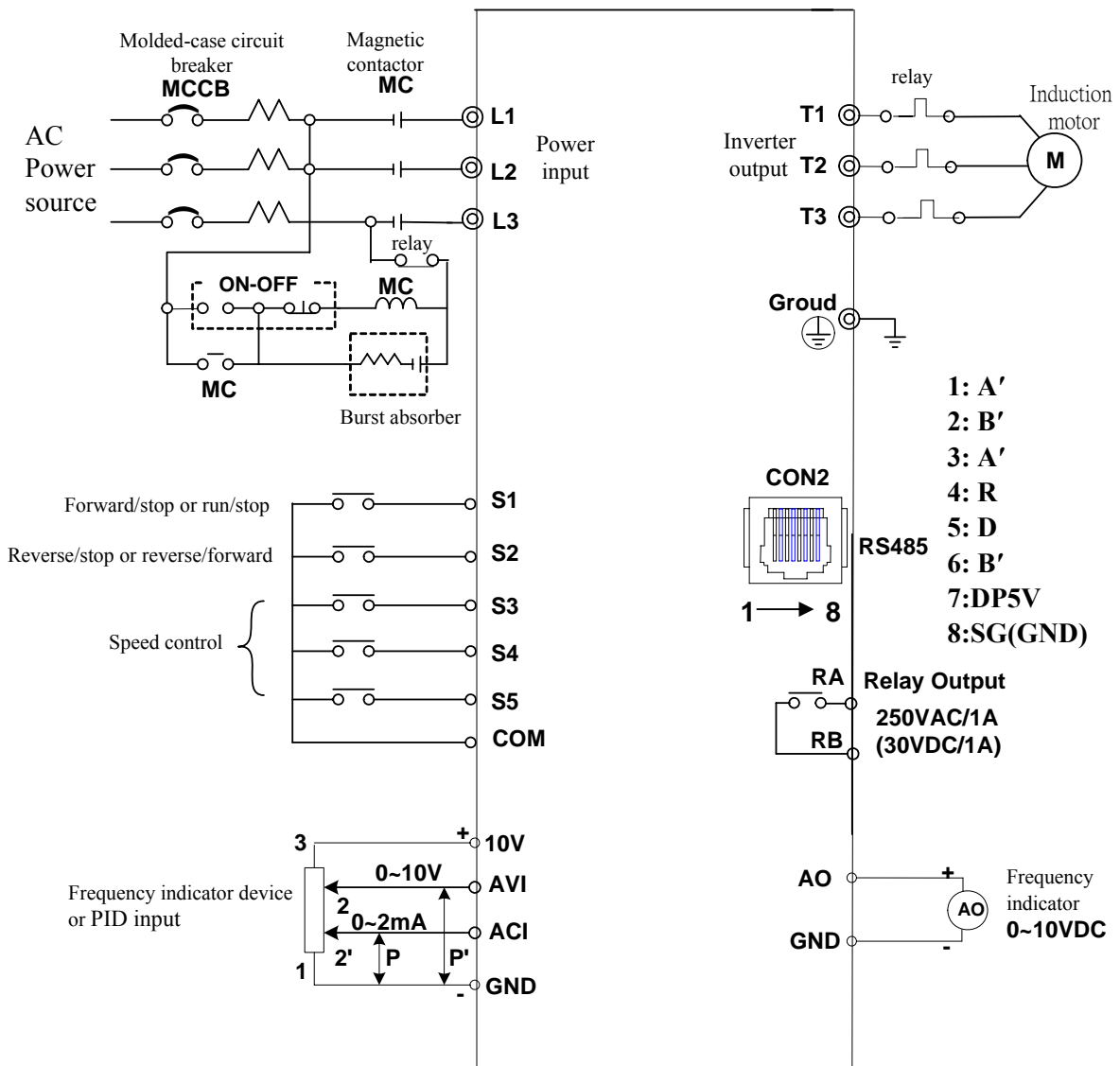

Model:

**200V: L510-2P2-H3-N/ L510-2P5-H3-N / L510-201-H3-N /
L510-202-H3-N / L510-203-H3-N**

3.6 Terminal Description

3.6.1 Description of main circuit terminals

Terminal symbols	TM1 Function Description
L1	Main power input: Single-phase: L1、 L2 Three-phase: L1、 L2、 L3
L2	
L3	
T1	Inverter output, connect to U, V, W port of motor
T2	
T3	
	Ground terminal

Single phase

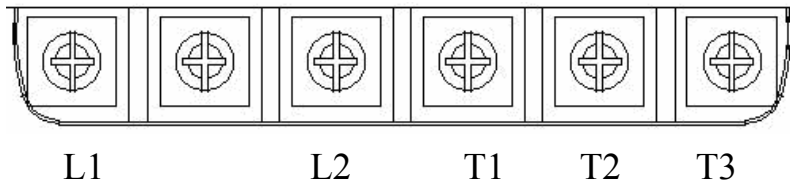

Three phase

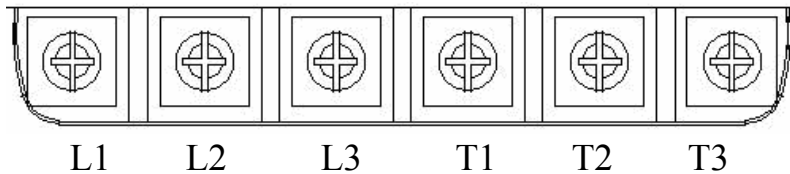

3.6.2 Control circuit terminal description

Terminal symbols	TM1 Function Description
RA	Relay output terminal, Specification: 250VAC/1A(30VDC/1A)
RB	
COM	S1 ~ S5 public Point (COMMON) 【NPN】
+12V	S1 ~ S5 public Point (COMMON) 【PNP】
S1	Multi-function input terminals(refer to group3)
S2	
S3	
S4	
S5	
10V	Frequency setting potentiometer (VR) Power terminal
AVI	Analog voltage input, Specification: 0~10VDC
ACI	Analog current input, Specification: 0~20mA
AO	Analog output positive port, Specification: Maximum output 10VDC/1mA
AGND	the analog ground terminal

NPN:

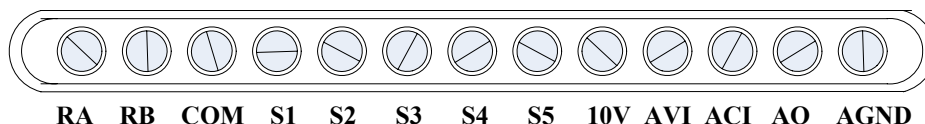

PNP:

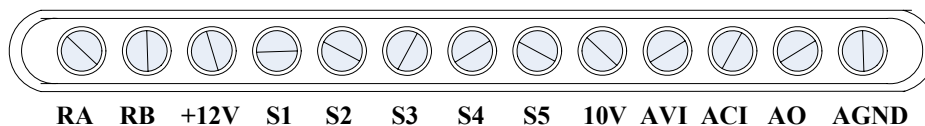

3.7 Outline Dimensions (unit: mm)

Frame1

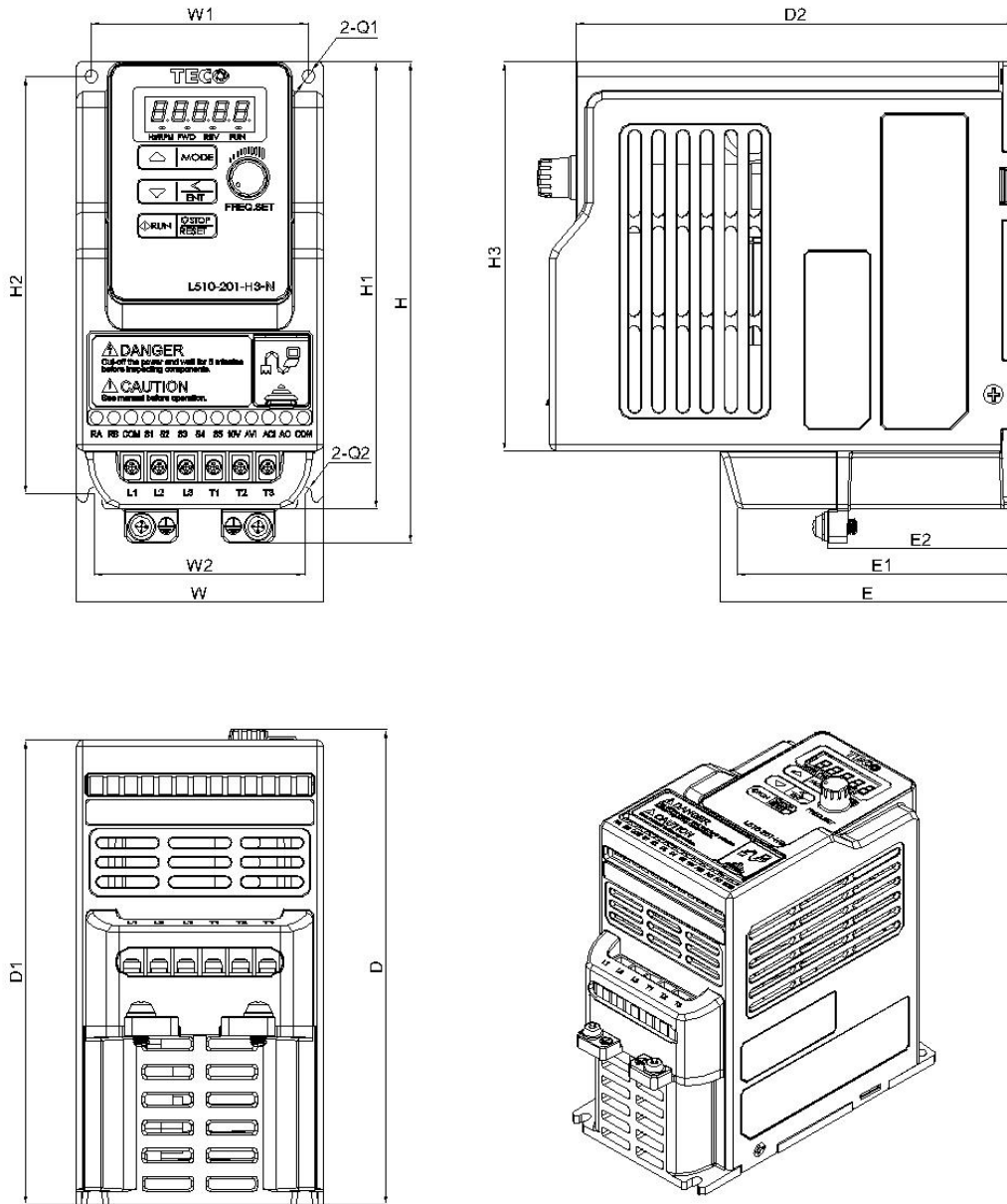

Power	Model	Dimension														
		W	W1	W2	H	H1	H2	H3	D	D1	D2	E	E1	E2	Q1	Q2
100V Single- phase	L510-1P2-H1-N	72	63	61	141	131	122	114	139	136	128	86.3	81.1	55	4.3	2.2
	L510-1P5-H1-N															
	L510-101-H1-N															
200V Single- phase	L510-2P2-H1-N															
	L510-2P5-H1-N															
	L510-201-H1-N															
	L510-2P2-H1F-P															
200V Three- phase	L510-2P5-H1F-P															
	L510-201-H1F-P															
	L510-201-H3-N															
	L510-2P2-H3-N															
	L510-2P5-H3-N															
	L510-201-H3-N															

Frame2

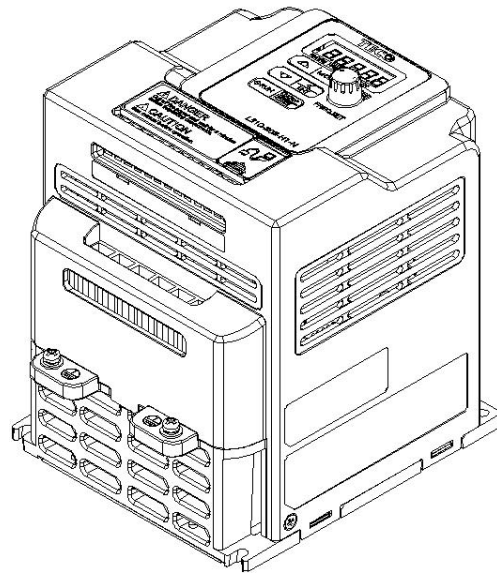
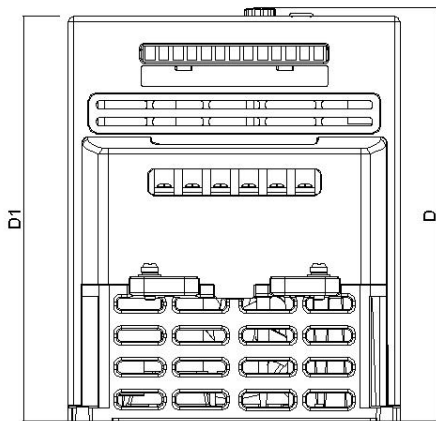
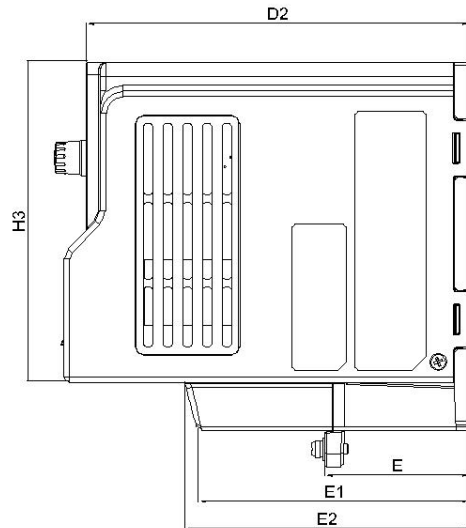
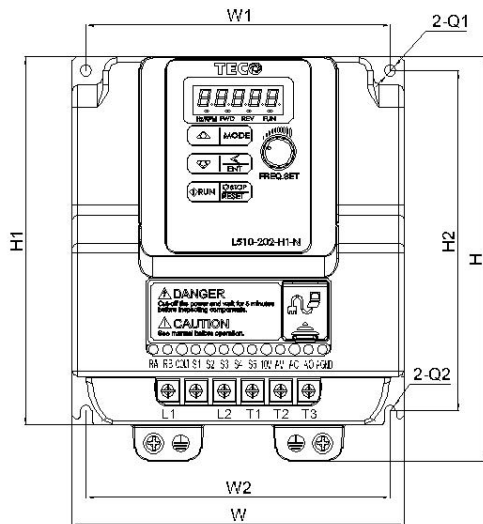

Power	Model	Dimension														
		W	W1	W2	H	H1	H2	H3	D	D1	D2	E	E1	E2	Q1	Q2
200V Single- phase	L510-202-H1-N	118	108	108	144	131	121	114	147	144	136	101	96	51	4.3	2.2
	L510-203-H1-N															
	L510-202-H1F-P															
	L510-203-H1F-P															
200V Three- phase	L510-202-H3-N	118	108	108	144	131	121	114	147	144	136	101	96	51	4.3	2.2
	L510-203-H3-N															

Chapter4 Software Index

4.1 Keypad Description

4.1.1 Panel Function



Type	Name	Function
Display	Main display area	Frequency Display,Parameter, voltage,Current,Temperature , abnormal and ect.
	Status display area	<p>Hz/RPM: When the panel shows the frequency, this indicator is lit (long bright light while inverter running, flicker while inverter stopping)</p> <p>FWD: When the inverter is running forward, this indicator is lit (long bright light while inverter running, flicker while inverter stopping)</p> <p>REV: When the inverter is running reverse, this indicator is lit (long bright light while inverter running, flicker while inverter stopping)</p> <p>MOD: When the panel shows parameter menu, this indicator is lit</p>
rheostat	Panel rheostat	Can be used to set the frequency
Button (6 buttons)	RUN	RUN: Enable the inverter run operation
	STOP/RESET (Dual function keys)	STOP: Enable the inverter stop operation RESET:When the inverter failure, can be used to reset it
	▲	Used to check the code or increase the parameter value
	▼	Used to check the code or reduce the parameter values
	MOD	MOD: Switch the display content
	</ENTER (Dual function keys, a short press for left shift function, a long press for ENTER function)	<p>“<”Left Shift: used while changing the parameters or parameter values</p> <p>ENTER: ①Turn to parameter values menu from parameter settings menu, for example: in the 00-00 screen, press this button, it shows 0 (parameter value) ②used to confirm after modifying the parameters or parameter values</p>

4.1.2 Show Description

Numbers and letters show







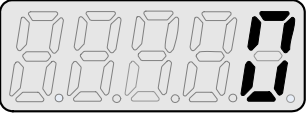

Reality show	LED	Reality show	LED	Reality show	LED	Reality show	LED
0		A		n		Y	
1		b		o		-	
2		C		P		o	
3		d		q		.	
4		E		r		.	
5		F		S			
6		G		t			
7		H		u			
8		J		v			
9		L					

Digital tube lights flashing instructions

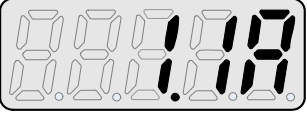



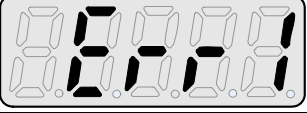

Actual output frequency	Set frequency	
LED lights	All lights flashing	Select Location flashing

LED display

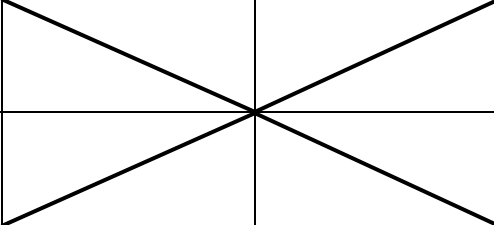
Display	Directions
	<ol style="list-style-type: none"> 1. when Stop show the set frequency 2. when running show the actual output frequency
	Show Parameter

	Show Parameter Value
	Show output Voltage
	Show output Current
	Show DC voltage
	Show Temperature
	Show PID feedback
	Error display
	ACI / AVI(0~1000)

Description of indicator light lighting and flickering

	Indicator light lights		Indicator light flickers	
	Commentary in the manual		Commentary in the manual	
Frequency / linear speed Indicator light	 Hz/RPM	lights while displaying frequency or linear speed		
Menu mode indicator light	 FUN	lights while not displaying frequency or linear		
FWD indicator light	 FWD	lights while running forward	 FWD	flickers while stopping forward
REV indicator light	 REV	lights while running reverse	 REV	flickers while stopping reverse

4.1.3 Function structure of LED digital tube displaying

Basic screen shows as below:

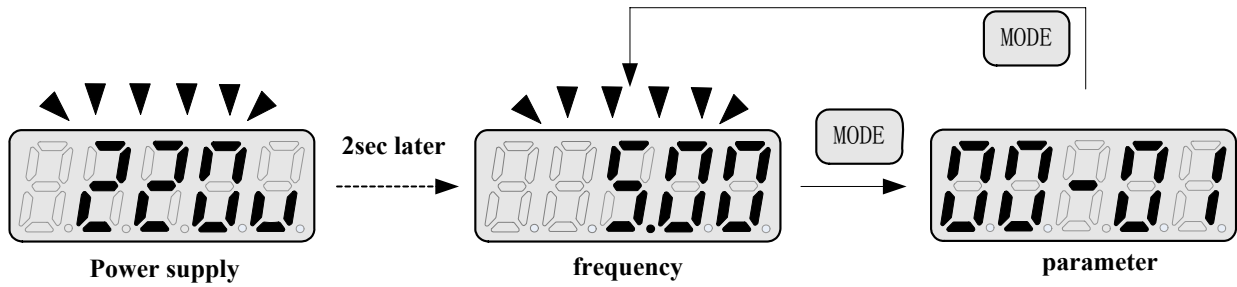

User modify screen shows as below:

12- 00	Display Mode
Range	0 0 0 0 0
	high Low
	00000~77777 Each of the range of 0 to 7
	【0】 :Disable display 【1】 :output Current
	【2】 :output Voltage 【3】 :DC voltage
	【4】 :Temperature 【5】 :PID feedback
	【6】 :AVI 【7】 :ACI

The highest bit of 12-00 sets the power on destined menu, other bits set user setting menus

Example1: 12- 00= 【10000】

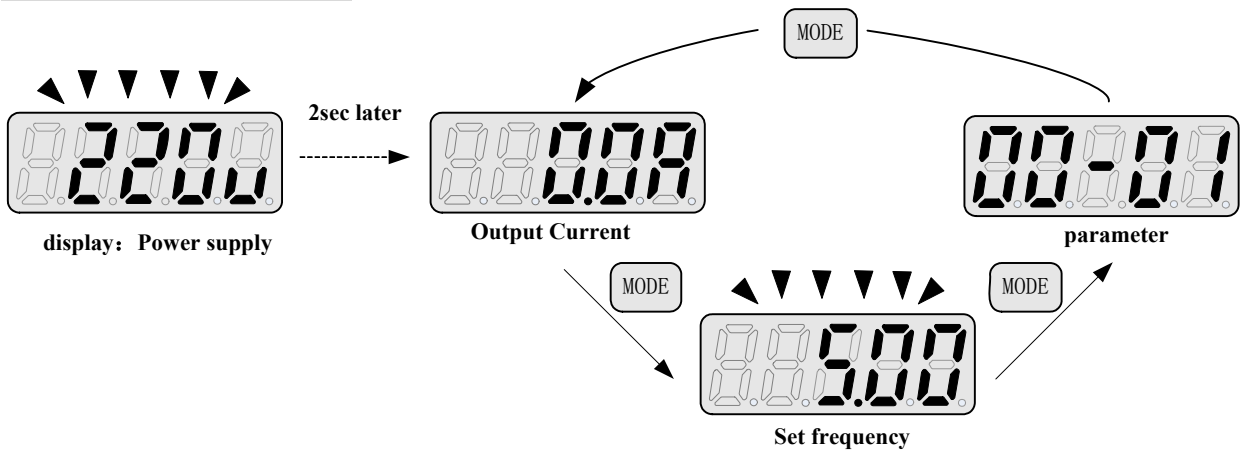

Example2: 12- 00= 【12345】

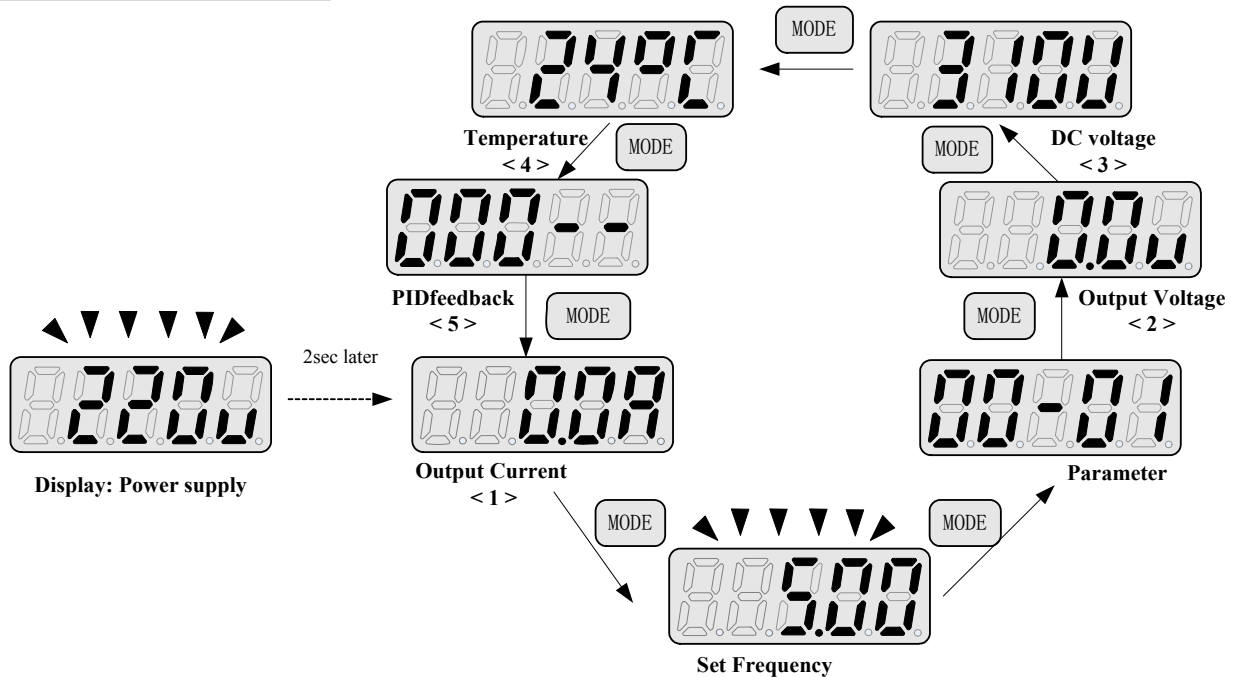

Special key note:

1. “▲”/“▼”:

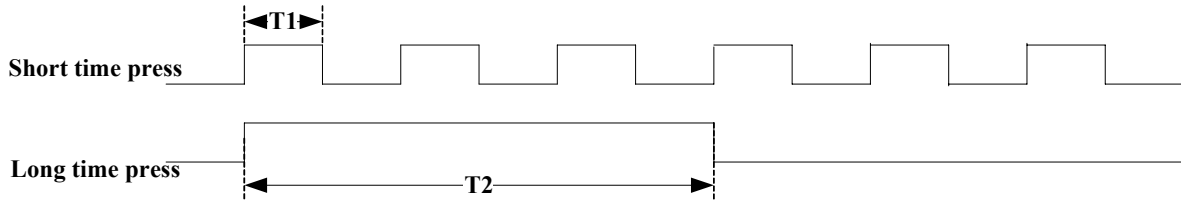

Short pressing changes the number of the selected bit by unitage; long pressing changes the number of the selected bit continuously.

2. “</ENT”:

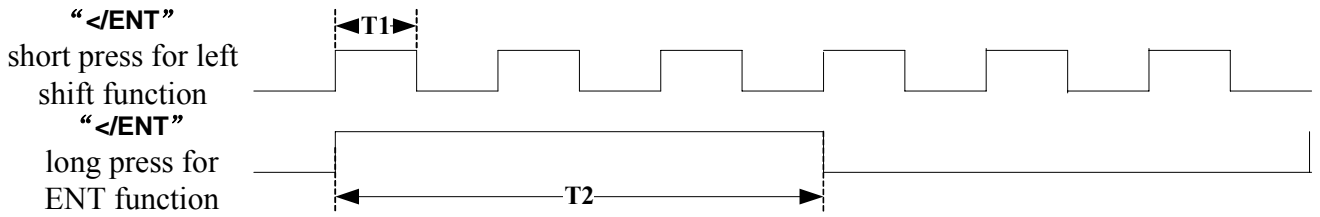

For example: Showing 00 - 01, long press “</ ENT” to enter parameter value screen and showing “0”.(it can also used to confirm modifications)

a short press for left shift function, a long press for ENTER function.

4.1.4 Example of keypad operation

Example 1: Modifying Parameters

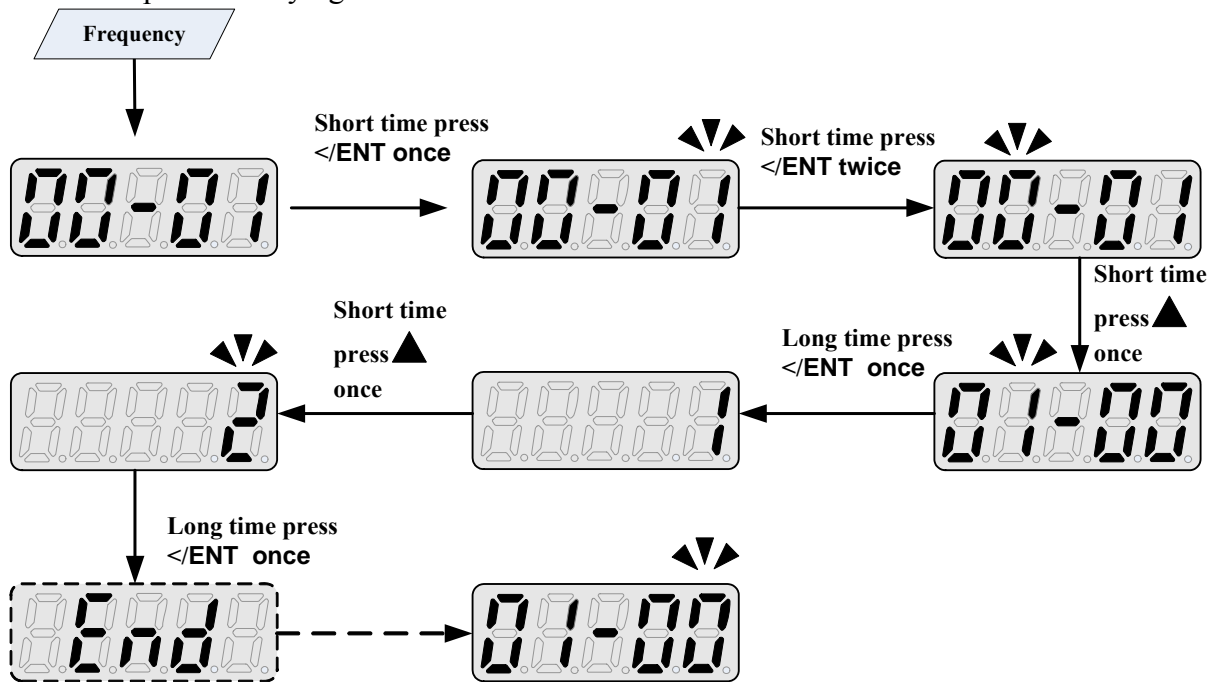

Example2: Modify the frequency while running and stopping with keypad.

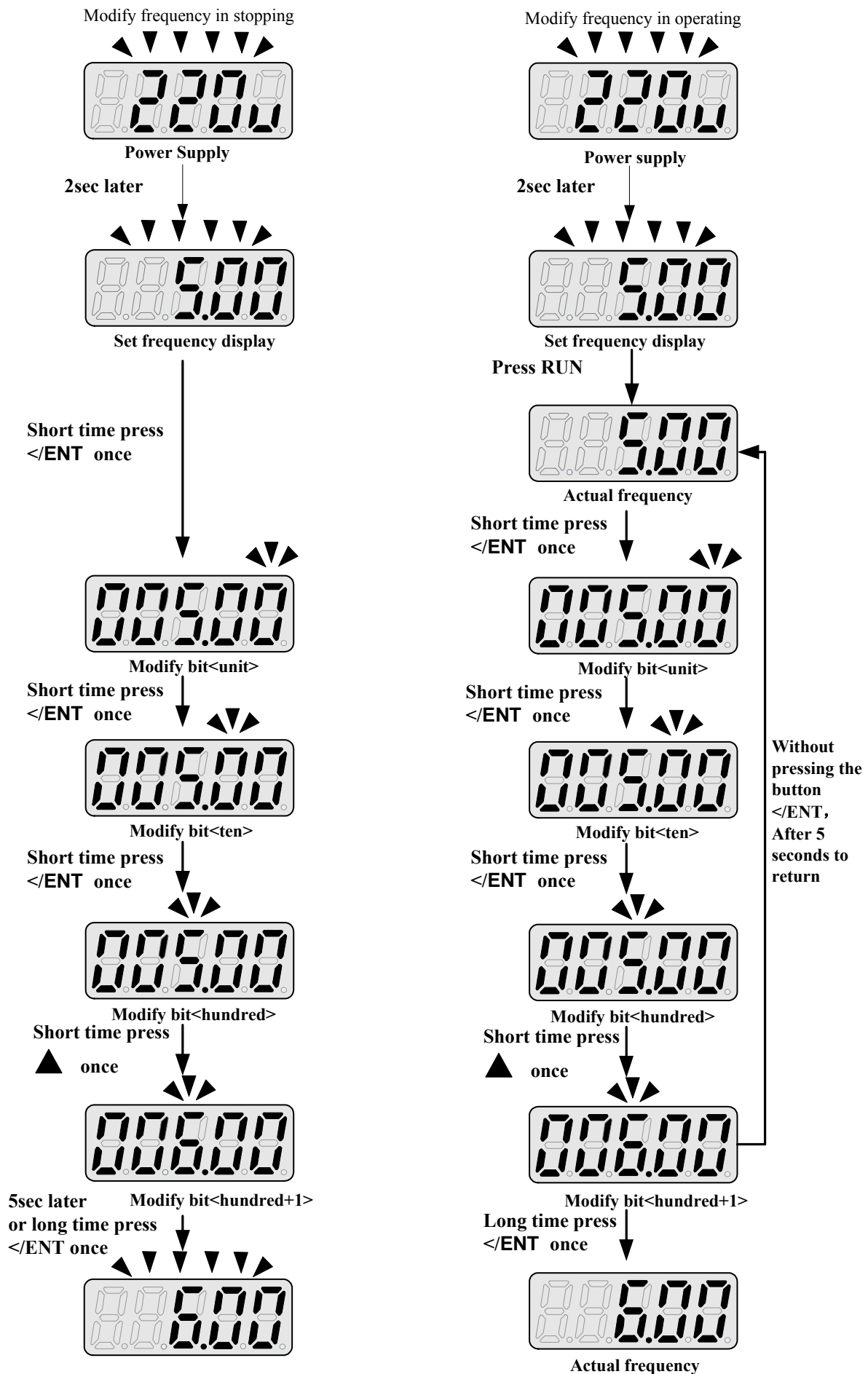

Notice: while changing frequency command by panel during running and stopping, it is limited between upper and lower limit frequency.

4.1.5 Operation Control

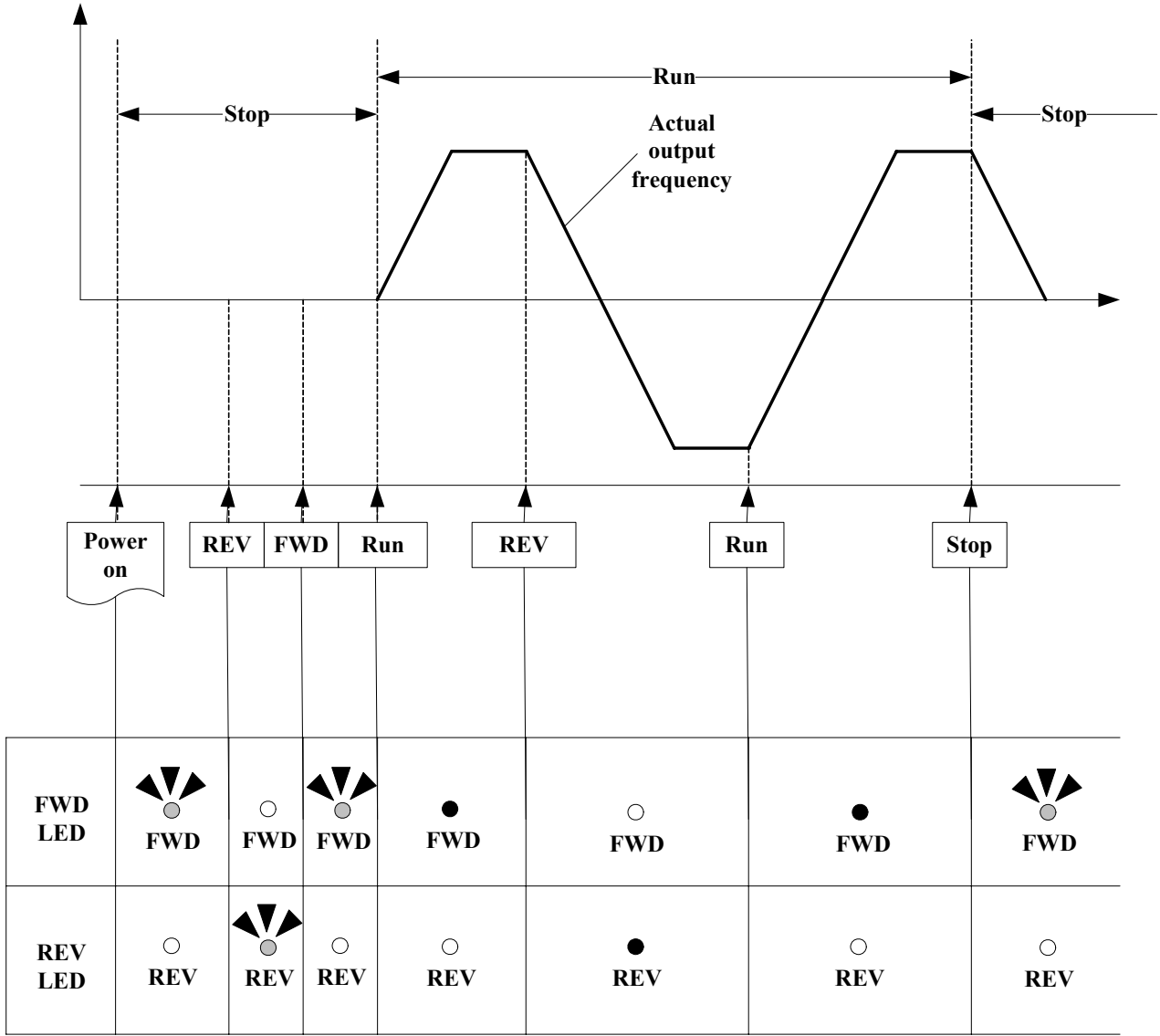

4.2 Programmable Functions List

Parameter Group No.	Description
Group 00	The basic parameters group
Group 01	V/F command group
Group 02	Motor parameter group
Group 03	External terminal digital signal input (output) function group
Group 04	External terminal analog signal input (output) function group
Group 05	Preset Frequency function group
Group 06	Auto Run(Auto Sequencer) function group
Group 07	Start/Stop command group
Group 08	Protection function group
Group 09	Communication function group
Group 10	PID function group
Group 11	Assistant function group
Group 12	Monitor function group
Group 13	Maintenance function group

Parameter attribute	
*1	Indicate this parameter can be adjusted during running mode
*2	Cannot be modified while communication is active
*3	Do not change while making factory setting
*4	Read only

Group 00- The basic parameters group					
No.	Description	Range	Factory Setting	Unit	attribute
00-00	Reserved				
00-01	Motor rotation	0:Forward 1:Reverse	0	-	*1
00-02	Main Run Command Source Selection	0:Keypad	0	-	
		1:External Run/Stop Control			
		2:Communication			
00-03	Subsidiary Run Command Source Selection	0:Keypad	0	-	
		1:External Run/Stop Control			
		2:Communication			
00-04	Operation modes for external terminals	0: Forward/Stop-Reverse/Stop	0	-	
		1: Run/Stop-Forward/Reverse			
		2: 3-Wire Control Mode-Run/Stop			
00-05	Main Frequency Command Source Selection	0:Keypad	0	-	
		1:Potentiometer on Keypad			
		2:External AVI Analog Signal Input			
		3:External ACI Analog Signal Input			
		4:External Up/Down Frequency Control			
		5:Communication setting Frequency			
		6:PID output control			
00-06	Subsidiary Frequency Command Source Selection	0:Keypad	4	-	
		1:Potentiometer on Keypad			
		2:External AVI Analog Signal Input			
		3:External ACI Analog Signal Input			
		4:External Up/Down Frequency Control			
		5:Communication setting Frequency			
		6:PID			
00-07	Combination of the Main and Subsidiary Frequency Command	0:Main and Subsidiary Frequency Command select input 1:Main + Subsidiary Frequency input	0	-	
00-08	Communication Frequency Command	0.00~650.00		Hz	*4
00-09	Frequency command memory mode	0:store frequency before power-down	0	-	
		1:Save Keypad Frequency			
00-10	Initial Frequency Selection (for keypad)	0:by Current Frequency Command	0	-	
		1:by 0 Frequency Command			
		2:by 00-11			
00-11	Initial Frequency set of Keypad	0.00~650.00	50.00/60.00	Hz	
00-12	Frequency Upper Limit	0.01~650.00	50.00/60.00	Hz	
00-13	Frequency Lower Limit	0.00~649.99	0.00	Hz	
00-14	Acceleration Time 1	0.1~3600.0	10.0	Sec	*1
00-15	Deceleration Time 1	0.1~3600.0	10.0	Sec	*1
00-16	Acceleration Time 2	0.1~3600.0	10.0	Sec	*1
00-17	Deceleration Time 2	0.1~3600.0	10.0	Sec	*1
00-18	Jog Frequency	1.00~25.00	2.00	Hz	*1
00-19	Jog Acceleration Time	0.1~25.5	0.5	Sec	*1
00-20	Jog Deceleration Time	0.1~25.5	0.5	Sec	*1

Group 01-V/F command group					
No.	Description	Range	Factory Setting	Unit	attribute
01-00	Volts/Hz Patterns	1~7	1/4	-	
01-01	v/f max voltage	198.0~256.0	220.0	Vac	
01-02	Maximum Frequency	0.20 ~ 650.00	50.00/60.00	Hz	
01-03	Maximum Frequency Voltage Ratio	0.0 ~ 100.0	100.0	%	
01-04	Medium Frequency 2	0.10 ~ 650.00	25.00/30.00	Hz	
01-05	Medium Frequency Voltage Ratio2	0.0 ~ 100.0	50.0	%	
01-06	Medium Frequency 1	0.10 ~ 650.00	10.00/12.00	Hz	
01-07	Medium Frequency Voltage Ratio1	0.0 ~ 100.0	20.0	%	
01-08	Minimum Frequency	0.10 ~ 650.00	0.50/0.60	Hz	
01-09	Minimum Frequency Voltage Ratio	0.0 ~ 100.0	1.0	%	
01-10	Volts/Hz Curve Modification (Torque Boost)	0 ~ 10.0	0.0	%	*1
01-11	V/F start Frequency	0.00~10.00	0.00	Hz	

Group 02- Motor parameter group					
No.	Description	Range	Factory Setting	Unit	attribute
02-00	Motor No Load Current	----		Amps(AC)	*3
02-01	Motor Rated Current (OL1)	----		A	
02-02	Motor rated Slip Compensation	0.0 ~ 100.0	0.0	%	*1
02-03	Motor Rated Speed	----		Rpm	

Group 03- External terminal digital signal input(output) function group					
No.	Description	Range	Factory Setting	Unit	attribute
03-00	Multifunction Input Term. S1	0:Forward/Stop Command	0	-	
03-01	Multifunction Input Term. S2	1:Reverse/Stop Command	1	-	
03-02	Multifunction Input Term. S3	2:Preset Speed unit 0(5-02)	8	-	
03-03	Multifunction Input Term. S4	3:Preset Speed unit 1(5-03)	9	-	
03-04	Multifunction Input Term. S5	4:Preset Speed unit 2(5-05)	17	-	
		6:Jog Forward Command			
		7:Jog Reverse Command			
		8:Up Command			
		9:Down Command			
		10:Acc/Dec 2			
		11:Acc/Dec Disabled			
		12:Main/Alt run Command select			
		13:Main/Alt Frequency Command select			
		14:Emergency Stop			
15: Base Block					
16:PID Function Disabled					
17:Reset					
18:Auto Run Mode enable					
03-05	Reserved				
03-06	Up/Down frequency width	0.00~5.00	0.00	Hz	
03-07	Up/Down keep Frequency mode	0:When Up/Down is used, the preset frequency is held as the inverter stops, and the UP/Down function is disabled.	0	-	
		1:When Up/Down is used, the preset frequency is reset to 0 Hz as the inverter stops.			
		2:When Up/Down is used, the preset frequency is held as the inverter stops, and the UP/Down is available.			
03-08	S1~S5 confirm the scan times	1~400	20	1mSec	
03-09	S1~ S5 switch type select	xxxx0:S1 NO xxx1:S1 NC	00000	-	
		xxx0x:S2 NO xxx1x:S2 NC			
		xx0xx:S3 NO xx1xx:S3 NC			
		x0xxx:S4 NO x1xxx:S4 NC			
		0xxxx:S5 NO 1xxxx:S5 NC			
03-10	Reserved				
03-11	Output Relay(RY1)	0:Run	0	-	
		1:Fault			
		2:setting Frequency			
		3:Frequency Reached (3-13±3-14)			
		4:Frequency Threshold Level (> 3-13) - Frequency Reached			
		5:Frequency Threshold Level (< 3-13) - Frequency Reached			
		6:Auto Restart			
		7:Momentary AC Power Loss			
		8:Emergency Stop Mode			
		9:Base Block Stop Mode			
		10:Motor Overload Protection(OL1)			
		11:Drive Overload Protection(OL2)			
		13:Output current Reached			
		14:Brake control			

03-12	Reserved				
03-13	Frequency Output Setting (Hz)	0.00~650.00	0.00	Hz	*1
03-14	Frequency Detection Range	0.00~30.00	2.00	Hz	*1
03-15	Output current Reached Level(A)	0.1~15.0	0.1	A	
03-16	Output current detection time(s)	0.1~10.0	0.1	Sec	
03-17	Brake Release Level	0.00~20.00	0.00	Hz	
03-18	Brake Engage Level	0.00~20.00	0.00	Hz	
03-19	Relay Output format	0:A (Normal open) 1:B (Normal close)	0	-	

※ “NO”: Normal open, “NC”: Normal close.

Group 04- External terminal analog signal input(output) function group					
No.	Description	Range	Factory Setting	Unit	attribute
04-00	AVI/ACI analog Input signal type select	AVI ACI	0	-	
		0:0~10V 0~20mA			
		1:0~10V 4~20mA			
		2:2~10V 0~20mA			
		3:2~10V 4~20mA			
04-01	AVI Signal Verification Scan	1~400	100	1mSec	
04-02	AVI Gain	0 ~ 1000	100	%	*1
04-03	AVI Bias	0 ~ 100	0	%	*1
04-04	AVI Bias Selection	0: Positive 1: Negative	0	-	*1
04-05	AVI Slope	0: Positive 1: Negative	0	-	*1
04-06	ACI Signal Verification Scan	1~400	100	1mSec	
04-07	ACI Gain	0 ~ 1000	100	%	*1
04-08	ACIBias	0 ~ 100	0	%	*1
04-09	ACI Bias Selection	0: Positive 1: Negative	0	-	*1
04-10	ACI Slope	0: Positive 1: Negative	0	-	*1
04-11	Analog Output Mode(AO)	0: Output Frequency 1: Frequency Setting 2: Output Voltage 3: DC Bus Voltage 4: Motor Current	0	-	*1
04-12	Analog OutputAO Gain (%)	0 ~ 1000	100	%	*1
04-13	Analog Output AO Bias (%)	0 ~ 1000	0	%	*1
04-14	AO Bias Selection	0: Positive 1: Negative	0	-	*1
04-15	AO Slope	0: Positive 1: Negative	0	-	*1

Group 05- Preset Frequency function group					
No.	Description	Range	Factory Setting	Unit	attribute
05-00	Preset Speed Control mode Selection	0: common (Is uniform time(Acc1/Dec1or Acc2/Dec2)	0	-	
		1: special (Is single time Acc0/Dec0~ Acc7/Dec7)			
05-01	Preset Speed 0 (Keypad Freq)	0.00 ~ 650.00	5.00	Hz	
05-02	Preset Speed1 (Hz)		5.00	Hz	*1
05-03	Preset Speed2 (Hz)		10.00	Hz	*1
05-04	Preset Speed3 (Hz)		20.00	Hz	*1
05-05	Preset Speed4 (Hz)		30.00	Hz	*1
05-06	Preset Speed5 (Hz)		40.00	Hz	*1
05-07	Preset Speed6 (Hz)		50.00	Hz	*1
05-08	Preset Speed7 (Hz)		50.00	Hz	*1
05-09 ~ 05-16	Reserved				
05-17	Preset Speed0-Acctime	0.1 ~ 3600.0	10.0	Sec	*1
05-18	Preset Speed0-Dectime		10.0	Sec	*1
05-19	Preset Speed1-Acctime		10.0	Sec	*1
05-20	Preset Speed1-Dectime		10.0	Sec	*1
05-21	Preset Speed2-Acctime		10.0	Sec	*1
05-22	Preset Speed2-Dectime		10.0	Sec	*1
05-23	Preset Speed3-Acctime		10.0	Sec	*1
05-24	Preset Speed3-Dectime		10.0	Sec	*1
05-25	Preset Speed4-Acctime		10.0	Sec	*1
05-26	Preset Speed4-Dectime		10.0	Sec	*1
05-27	Preset Speed5-Acctime		10.0	Sec	*1
05-28	Preset Speed5-Dectime		10.0	Sec	*1
05-29	Preset Speed6-Acctime		10.0	Sec	*1
05-30	Preset Speed6-Dectime		10.0	Sec	*1
05-31	Preset Speed7-Acctime		10.0	Sec	*1
05-32	Preset Speed7-Dectime	10.0	Sec	*1	

Group 06- Auto Run(Auto Sequencer) function group					
No.	Description	Range	Factory Setting	Unit	attribute
06-00	Auto Run(sequencer) mode selection	0: Disabled. 1: Single cycle. (Continues to run from theUnfinished step if restarted). 2: Periodic cycle. (Continues to run from the unfinished step if restarted). 3: Single cycle, then holds the speed Of final step to run. (Continues to run from the unfinished step if restarted). 4: Single cycle. (Starts a new cycle if restarted). 5: Periodic cycle. (Starts a new cycle if restarted). 6: Single cycle, then hold the speed of final step to run. (Starts a new cycle if restarted).	0	-	
06-01	Auto _ Run Mode Frequency Command 1	0.00~650.00	0.00	Hz	*1
06-02	Auto _ Run Mode Frequency Command 2		0.00	Hz	*1
06-03	Auto _ Run Mode Frequency Command 3		0.00	Hz	*1
06-04	Auto _ Run Mode Frequency Command 4		0.00	Hz	*1
06-05	Auto _ Run Mode Frequency Command 5		0.00	Hz	*1
06-06	Auto _ Run Mode Frequency Command 6		0.00	Hz	*1
06-07	Auto _ Run Mode Frequency Command 7		0.00	Hz	*1
06-08 ~ 06-15	Reserved				
06-16	Auto_ Run Mode Running Time Setting 0	0.0 ~ 3600.0	0.0	Sec	
06-17	Auto_ Run Mode Running Time Setting 1		0.0	Sec	
06-18	Auto_ Run Mode Running Time Setting 2		0.0	Sec	
06-19	Auto_ Run Mode Running Time Setting 3		0.0	Sec	
06-20	Auto_ Run Mode Running Time Setting 4		0.0	Sec	
06-21	Auto_ Run Mode Running Time Setting 5		0.0	Sec	
06-22	Auto_ Run Mode Running Time Setting 6		0.0	Sec	
06-23	Auto_ Run Mode Running Time Setting 7		0.0	Sec	

06-24 ~ 06-31	Reserved				
06-32	Auto_Run Mode Running Direction 0	0:stop 1: forward 2: reverse	0	-	
06-33	Auto_Run Mode Running Direction 1		0	-	
06-34	Auto_Run Mode Running Direction 2		0	-	
06-35	Auto_Run Mode Running Direction 3		0	-	
06-36	Auto_Run Mode Running Direction 4		0	-	
06-37	Auto_Run Mode Running Direction 5		0	-	
06-38	Auto_Run Mode Running Direction 6		0	-	
06-39	Auto_Run Mode Running Direction 7		0	-	

Group 07- Start/Stop command group					
No.	Description	Range	Factory Setting	Unit	attribute
07-00	Momentary Power Loss and Restart	0: Momentary Power Loss and Restart disable 1: Momentary power loss and restart enable	0	-	
07-01	Auto Restart Delay Time	0.0~800.0	0.0	Sec	
07-02	Number of Auto Restart Attempts	0~10	0	-	
07-03	Reset Mode Setting	0: Enable Reset Only when Run Command is Off 1: Enable Reset when Run Command is On or Off	0	-	
07-04	Direct Running After Power Up	0: Enable Direct running after power up 1: Disable Direct running after power up	1	-	
07-05	Delay-ON Timer	1.0~300.0	1.0	Sec	
07-06	DC Injection Brake Start Frequency (Hz) @stopped	0.10 ~ 10.00	1.5	Hz	
07-07	DC Injection Brake Level (%) @Stopped	0 ~20	5	%	
07-08	DC Injection Brake Time (Seconds) @stopped	0.0 ~ 25.5	0.5	Sec	

Group 08- Protection function group					
No.	Description	Range	Factory Setting	Unit	attribute
08-00	Trip Prevention Selection	xxxx0: Enable Trip Prevention During Acceleration xxxx1: Disable Trip Prevention During Acceleration xxx0x: Enable Trip Prevention During Deceleration xxx1x: Disable Trip Prevention During Deceleration xx0xx: Enable Trip Prevention in Run Mode xx1xx: Disable Trip Prevention in Run Mode x0xxx: Enable over voltage Prevention in Run Mode x1xxx: Disable over voltage Prevention in Run Mode	00000	-	
08-01	Trip Prevention Level During Acceleration (%)	50 ~ 200	200	Inverter Rated Current 100%	
08-02	Trip Prevention Level During Deceleration (%)	50 ~ 200	200	Inverter Rated Current 100%	
08-03	Trip Prevention Level In Run Mode (%)	50 ~ 200	200	Inverter Rated Current 100%	
08-04	over voltage Prevention Level in Run Mode	350~390	380	VDC	
08-05	Electronic Motor Overload Protection Operation Mode	0: Enable Electronic Motor Overload Protection 1: Disable Electronic Motor Overload Protection	0	-	
08-06	Operation After Overload Protection is Activated	0: Coast-to-Stop After Overload Protection is Activated 1: Drive Will Not Trip when Overload Protection is Activated (OL1)	0	-	
08-07	OH over heat Protection (cooling fan control)	0: Auto (Depends on temp.) 1: Operate while in RUN mode 2: Always Run 3: Disabled	1	-	
08-08	AVR Function	0: AVR function enable	4	-	
		1: AVR function Disable			
		2: AVR function disable for stop			
		3: AVR function disable for Deceleration.			
		4: AVR function disable for stop and Deceleration.			
5: when VDC>360V · AVR function disable for stop and Deceleration.					
08-09	Input phase lost protection	0: Disabled 1: Enabled	0	-	

Group 09- Communication function group					
No.	Description	Range	Factory Setting	Unit	attribute
09-00	Assigned Communication Station Number	1 ~ 32	1	-	*2*3
09-01	RTU code /ASCII code select	0:RTU code 1:ASCII code	0	-	*2*3
09-02	Baud Rate Setting (bps)	0:4800 1:9600 2:19200 3:38400	2	bps	*2*3
09-03	Stop Bit Selection	0:1 Stop Bit 1:2 Stop Bits	0	-	*2*3
09-04	Parity Selection	0:Without Parity 1:With Even Parity 2:With Odd Parity	0	-	*2*3
09-05	Data Format Selection	0: 8-Bits Data 1: 7-Bits Data	0	-	*2*3
09-06	Communication time-out detection time	0.0 ~ 25.5	0.0	Sec	
09-07	Communication time-out operation selection	0:Deceleration to stop (00-15: Deceleration time 1) 1:Coast to stop 2: Deceleration to stop (00-17: Deceleration time 2) 3: continue operating	0	-	
09-08	Err6 fault tolerance times	1 ~ 20	3		
09-09	Drive Transmit Wait Time (ms)	5 ~ 65	5	mSec	

Group10- PID function group

No.	Description	Range	Factory Setting	Unit	attribute
10-00	PID target value selection (when 00-03\00-04=6, this function is enabled)	0:Potentiometer on Keypad 1: External AVI Analog Signal Input 2: External ACI Analog Signal Input 3:Communication setting Frequency 4:By 10-02	1	-	*1
10-01	PID feedback value selection	0:Potentiometer on Keypad 1:External AVI Analog Signal Input 2:External ACI Analog Signal Input 3:Communication setting Frequency	2	-	*1
10-02	PID keypad input	0.0~100.0	50.0	%	*1
10-03	PID Mode Selection	0:Disabled 1: Bias D Control 2: Feedback D Control 3: PIDcontrol, Bias D reversed Characteristics control 4: PIDcontrol, feedback D reversed Characteristics control	0	-	
10-04	Feedback Gain coefficient	0.00 ~ 10.00	1.00	%	*1
10-05	Proportional Gain	0.0 ~ 10.0	1.0	%	*1
10-06	Integration Time	0.0 ~ 100.0	10.0	Sec	*1
10-07	Differentiation Time	0.00 ~ 10.00	0.00	Sec	*1
10-08	PID Offset	0: Positive 1: Negative	0	-	*1
10-09	PID Offset Adjust	0 ~ 109	0	%	*1
10-10	PID Output Lag Filter Time	0.0 ~ 2.5	0.0	Sec	*1
10-11	Feedback Loss Detection Mode	0: Disabled 1: Enabled - Drive Continues to Operate After Feedback Loss 2: Enabled - Drive "STOPS" After Feedback Loss	0	-	
10-12	Feedback Loss Detection Level	0 ~ 100	0	%	
10-13	Feedback Loss Detection Delay Time	0.0 ~25.5	1.0	Sec	
10-14	Integration Limit Value	0 ~ 109	100	%	*1
10-15	Integration Value Resets to Zero when Feedback Signal Equals the Intended Value	0:Disabled 1: 1 Second 30: 30 Seconds 0 ~ 30	0	-	
10-16	Allowable Integration Error Margin (Units) (1 Unit = 1/8192)	0 ~ 100	0	-	
10-17	PID Sleep Frequency Level	0.00~650.00	0.00	Hz	
10-18	PID Sleep Function Delay Time	0.0 ~25.5	0.0	Sec	
10-19	PID Wake up frequency Level	0.00 ~ 650.00	0.00	Hz	
10-20	PID Wake up function Delay Time	0.0 ~ 25.5	0.0	Sec	
10-21	Max PID Feedback Setting	0 ~999	100	-	*1
10-22	Min PID Feedback Setting	0 ~999	0	-	*1

Group11- Assistant function group					
No.	Description	Range	Factory Setting	unit	attribute
11-00	Reverse operation control	0: Reverse command is enabled 1: Reverse command is disabled	0	-	
11-01	Carrier Frequency (kHz)	1~16	5	KHz	
11-02	Carrier mode Selection	0:Carrier mode0 3-phase PW M modulation 1:Carrier mode1 2-phase PW M modulation 2:Carrier mode0 2 2-phase randomized PW M modulation	0	-	
11-03	Carrier Frequency Reduction by temperature raising	0:disabled 1:enabled	0	-	
11-04	S-Curve Acc 1	0.0 ~ 4.0	0.00	Sec	
11-05	S-Curve Acc 2	0.0 ~ 4.0	0.00	Sec	
11-06	S-Curve Dec 3	0.0 ~ 4.0	0.00	Sec	
11-07	S-Curve Dec 4	0.0 ~ 4.0	0.00	Sec	
11-08	Skip Frequency 1	0.00 ~ 650.00	0.00	Hz	*1
11-09	Skip Frequency 2	0.00 ~ 650.00	0.00	Hz	*1
11-10	Skip Frequency 3	0.00 ~ 650.00	0.00	Hz	*1
11-11	Skip Frequency Bandwidth (±)	0.00 ~ 30.00	0.00	Hz	*1

Group12 Monitor function group

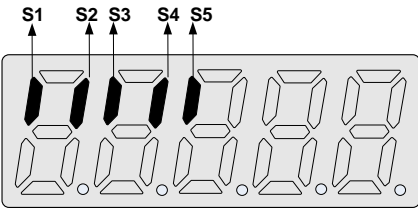
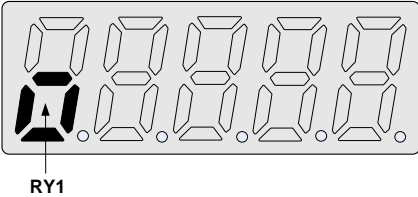
No.	Description	Range	Factory Setting	Unit	attribute
12-00	Display Mode	00000~77777 Each of the range of 0 to 7	00000	-	*1
		0:Disable display			
		1:output Current			
		2:output Voltage			
		3:DC voltage			
		4:Temperature			
		5:PID feedback			
		6:AVI			
7:ACI					
12-01	PID Feedback Display Mode	0:Displayed in Integer (xxx)	0	-	*1
		1:Displayed with One Decimal Place (xx.x)			
		2:Displayed with Two Decimal Places (x.xx)			
12-02	PID Feedback Display Unit Setting	0:xxx--	0	-	*1
		1:xxxpb(pressure)			
		2:xxxfl(flow)			
12-03	Custom Units (Line Speed) Value	0~65535	1500/1800	RPM	*1
12-04	Custom Units (Line Speed) Display Mode	0:Drive Output Frequency is Displayed	0	-	*1
		1:Line Speed is Displayed in Integer (xxxxx)			
		2:Line Speed is Displayed with One Decimal Place (xxxx.x)			
		3:Line Speed is Displayed with Two Decimal Places (xxx.xx)			
		4:Line Speed is Displayed with Three Decimal Places (xx.xxx)			
12-05	Input and output terminal status display		-	-	*4
					

Group 13 Maintenance function group					
No.	Description	Range	Factory Setting	unit	attribute
13-00	Drive Horsepower Code	----	-	-	*3
13-01	Software Version	----	-	-	*3*4
13-02	Fault Log (Last 3 Faults)	----	-	-	*3*4
13-03	Accumulated Operation Time1 1	0~23	-	hour	*3
13-04	Accumulated Operation Time1 2	0~65535	----	day	*3
13-05	Accumulated Operation Time Mode	0:Time Under Power 1:Run Mode Time Only	0	-	*3
13-06	Parameter Lock	0:Enable all Functions 1:05-01~05-08 cannot be changed 2:All Functions cannot be changed Except 05-01~05-08 3:Disable All Function	0	-	
13-07	Parameter password	00000~65535	00000	-	
13-08	Reset Drive to Factory Settings	1150:Reset to the 50Hz factory setting 1160:Reset to the60Hz factory setting	00000	-	

4.3 Parameter Function Description

00- The basic parameters group

00- 01	Motor Direction Control
Range	【0】 :Forward 【1】 :Reverse

➤ 00 - 01 is effective only when keypad is used as the operation command source.

※Note: when l1- 00is set to 1, 00-01 is not set to 1, keypad display” LOC”.

00- 02	Main Run Command Source Select
00- 03	Alternative Run Command Source Select
Range	【0】 :Keypad 【1】 :External Run/Stop Control 【2】 :Communication

➤ Parameter 00 - 02/00- 03 sets the inverter operation command source. Switching between 00-02 and 00-03,see code range of external ports (03-00~03-04): **【12】** function description of main/sub frequency command.

00- 04	Operation modes for external terminals
Range	【0】 :Forward/stop-reverse/stop 【1】 :Run/stop-forward/reverse 【2】 :3-wire control mode -run/stop

➤ When operation command 00- 02/00- 03 =1 (external terminal), 00- 04 is valid.

2-wire operation mode: After setting 00- 04= **【0/1】** ,each of (03 - 00 03 - 04) can be set to **【0】** or **【1】**

00- 04= **【0】** , in external terminals function code,0 stand for fwd/stop,1 stand for rev/stop.

00- 04= **【1】** , in external terminals function code,0 stand for run/stop,1 stand for fwd/rev.

3-wire operation mode: 00 - 04 = **【2】** , then terminals S1, S2, S3 is combined to execute this function , no matter what the value is in 03 - 00,03 - 01,03 - 02. (refer to Group 03)

00- 05	Main Frequency Command Source Select
00- 06	Alternative Frequency Command Source Select
Range	【0】 :UP/DOWN of Keypad 【1】 :Potentiometer on Keypad 【2】 :External AVI Analog Signal Input 【3】 :External ACI Analog Signal Input 【4】 :External Up/Down Frequency Control 【5】 :Communication setting Frequency 【6】 :PID

➤ Parameter 00 - 05/00- 06 sets the inverter frequency command source.

➤ When 00 - 05/00- 06 = **【6】** , frequency command source is output of PID.

00- 07	Combination of the Main and Subsidiary FrequencyCommand
Range	【0】 :Main and Subsidiary Frequency Command select input 【1】 :Main + Subsidiary Frequency input

➤ When 00 - 07 = **【0】** , the frequency source is one of parameter 00 - 05 and 00 - 06, the default one is 00 - 05, when needs to switch to 00 - 06, an external multi-functional terminal function code **【13】**(Main / Sub frequency source switching) is needed see description of parameter (3-00 ~ 3-04).

00- 08	Communication Frequency Command
Range	【0.00~650.00】 Hz

➤ This parameter can be used to set frequency command or read communication frequency command (read only)

➤ This parameter is only effective in the communication mode.

00- 09	Saving Communication Frequency Command
Range	【0】 :disable 【1】 :enable

- This parameter is only effective in the communication mode.

00-10	Initial Frequency Selection
Range	【0】 :By Current Freq Command 【1】 :By Zero Freq Command 【2】 :By 00-11
00-11	Initial Frequency Setpoint
Range	【0.00~650.00】 Hz

- This parameter is only used when the frequency source is keypad.
- When 00-10= **【0】** ,the initial frequency will be current frequency.
- When 00-10= **【1】** ,the initial frequency will be 0.
- When 00-10= **【2】** ,the initial frequency will be 00-11.

00-12	Frequency Upper limit
Range	【0.01~650.00】 Hz
00-13	Frequency Lower limit
Range	【0.00~649.99】 Hz

- When 00-13 = **【0】** ,and the frequency command value is also zero, the inverter works in zero speed stopping state; When 00-13> 0, and the frequency command value ≤ 00-13, inverter output the frequency lower limit.

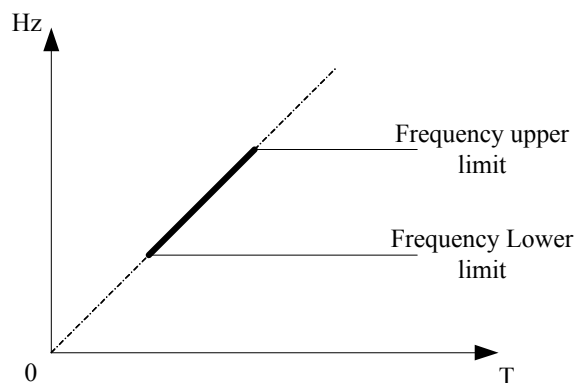

00-14	Acceleration time 1
Range	【0.1~3600.0】 Sec
00-15	Deceleration time 1
Range	【0.1~3600.0】 Sec
00-16	Acceleration time 2
Range	【0.1~3600.0】 Sec
00-17	Deceleration time 2
Range	【0.1~3600.0】 Sec

- Acceleration time is starting from the lowest frequency converter frequency to the maximum output frequency of the time spent.
- Deceleration time is the maximum output frequency from the frequency converter to minimize the initial frequency of the time spent.
- Actual acceleration and deceleration time is calculated as follows:

$$\text{Actual acceleration time} = \frac{(00-14) \times (\text{Set frequency} - \text{The minimum starting frequency})}{\text{Maximum output frequency}}$$

$$\text{Actual deceleration time} = \frac{(00-15) \times (\text{Set frequency} - \text{The minimum starting frequency})}{\text{Maximum output frequency}}$$

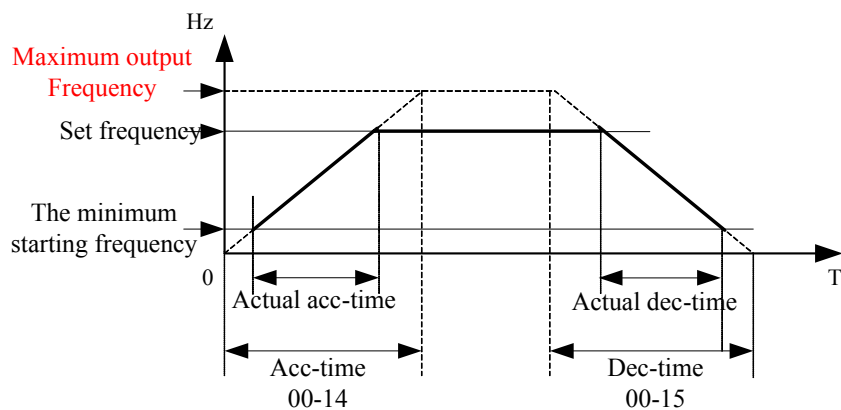

00-18	Jog Frequency
Range	【1.00~25.00】 Hz
00-19	Jog Acceleration Time
Range	【0.1~3600.0】 Sec
00-20	Jog Deceleration Time
Range	【0.1~3600.0】 Sec

- The JOG function is executed by setting multi-terminal parameter 03 - 00 ~03 - 04 to **【6 / 7】** .
(See figures in descriptions of parameter group 03).

01-V/F command group

01- 00	Volts/Hz Patterns (V/F)
Range	【1~7】

- 1. setting 01- 00= 【1~6】 means V / F curve is fixed (parameter 01 - 02 ~ 01 - 09 setting does not work).
- 2.6 fixed curves refer to the diagram:

TYPE	50Hz		60Hz	
Function	01-00	V/F pattern	01-00	V/F pattern
General Use	= 【1】		= 【4】	
High start torque	= 【2】		= 【5】	
Decreasing torque	= 【3】		= 【6】	

In figures above, "V" of 100% means the maximum output voltage, percentage of B, C is shown in tables below.

01- 00	B(Xb)	C(Xc)
1/4	10%	8%
2/5	15%	10.5%
3/6	25%	7.7%

- 3. Setting 01 - 00 = [7] means the 7th V / F curve is selected, users can set needed V / F curves by parameters (01 - 02 ~ 01 - 09).

01- 01	v/f Maximum voltage
Range	【198.0~256.0】 V
01- 02	Maximum Frequency
Range	【0.20 ~ 650.00】 Hz
01- 03	Maximum Frequency Voltage Ratio
Range	【0.0 ~ 100.0】 %
01- 04	Medium Frequency 2
Range	【0.10 ~ 650.00】 Hz
01- 05	Medium Frequency Voltage Ratio 2
Range	【0.0 ~ 100.0】 %
01- 06	Medium Frequency 1
Range	【0.10 ~ 650.00】 Hz
01- 07	Medium Frequency Voltage Ratio 1
Range	【0.0 ~ 100.0】 %
01- 08	Minimum Frequency
Range	【0.10 ~ 650.00】 Hz
01- 09	Minimum Frequency Voltage Ratio
Range	【0.0 ~ 100.0】 %

- If sets 01-00= **【7】** ,any V/F curve can be set with parameters 01- 02~01- 09,an the maximum output frequency depends on 01-02 setting.
- If 01-00 ≠ **【7】** , the maximum output frequency is fixed to 50.00HZ or 60.00HZ,and 01-02 does not work.

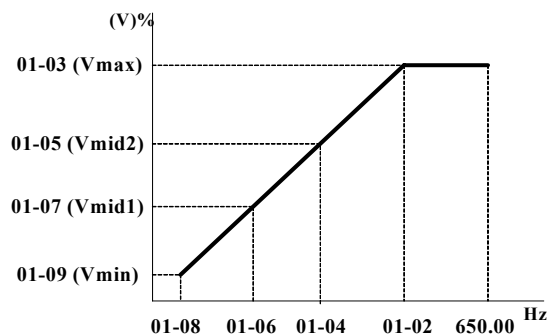

01-10	Volts/Hz Curve Modification (Torque Boost)
Range	【0 ~ 10.0】 %

- Inverter output a V / F curve composed by B, C and 01-10 setting to improve the output torque.
- Calculation of B, C point voltage: B point voltage = $X_b \times$ maximum output voltage, C point voltage = $X_c \times$ maximum output voltage (X_b, X_c see P4-16). When 01-10 = 0, the torque improvement is disabled.

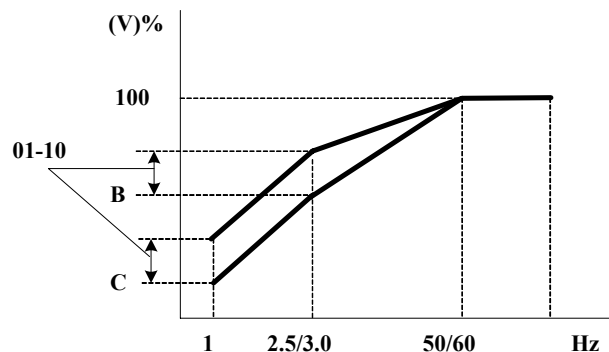

01-11	V/F start Frequency
Range	【0.00 ~10.00】 Hz

02- Motor parameter group

02- 00	Motor no load current
Range	----
02- 01	Motor Rated Current
Range	----
02- 02	Motor rated Slip Compensation
Range	【0.0 ~ 100.0】 (%)
02- 03	Motor Rated Speed
Range	----

- When the induction motor is in running, there must be slip due to the load. It is necessary to boost voltage to improve the precision of the speed.

$$\text{Slip frequency boost} = \frac{\text{Output Current} - (02-00)}{(02-01) - (02-00)} \times (02-02) \times \text{Rate motor slip}$$

$$\text{Rate motor slip} = \text{Motor synchronization speed} - \text{Motor Rated Speed}$$

$$(02-02) \text{ approximate Value} = \frac{\text{Motor synchronization speed} - \text{Rated speed}}{\text{Motor synchronization speed}}$$

Motor synchronization speed—Marked on the motor nameplate

$$\text{Motor synchronization speed (RPM)} = \frac{120}{\text{Motor Poles}} \times \text{Motor rated frequency (50Hz or 60Hz)}$$

$$\text{Example: 4Poles, 60Hz induction motor synchronization speed} = \frac{120}{4} \times 60 = 1800 \text{ (RPM)}$$

※Note: 02- 00/02- 01 differs with the inverter capacities(13- 00), It should be regulated according to actual conditions.

03- External terminal digital signal input (output) function group

03- 00	Multifunction Input Term. S1
03- 01	Multifunction Input Term. S2
03- 02	Multifunction Input Term. S3
03- 03	Multifunction Input Term. S4
03- 04	Multifunction Input Term. S5
Range	<p>【0】 :Forward/Stop Command----- (refer to 00- 02/00-03=1& 00-04)</p> <p>【1】 :Reverse/Stop Command----- (refer to 00- 02/00-03=1& 00-04)</p> <p>【2】 :Preset Speed unit 0 (5- 02) -----(5- 02) (refer to Group5)</p> <p>【3】 :Preset Speed unit 1(5- 03) -----(5- 03) (refer to Group5)</p> <p>【4】 :Preset Speed unit 2(5- 05) -----(5- 05) (refer to Group5)</p> <p>【6】 :JOG Forward Command----- (refer to 00-18~00-20)</p> <p>【7】 :JOG Reverse Command----- (refer to 00-18~00-20)</p> <p>【8】 :Up Command----- (refer to 00- 05/00- 06=4& 03-06/03-07)</p> <p>【9】 :Down Command----- (refer to 00- 05/00- 06=4& 03-06/03-07)</p> <p>【10】 :Acc/Dec time 2</p> <p>【11】 :Acc/Dec Disabled</p> <p>【12】 :Main/sub Control Signal Select---- (refer to 00- 02/00- 03)</p> <p>【13】 :Main/sub Frequency Command Select---- (refer to 00- 05/00- 06)</p> <p>【14】 :Emergency Stop (controlled deceleration stop)</p> <p>【15】 :Base Block (Coast to stop)</p> <p>【16】 :PID Function Disabled----- (refer to Goup10)</p> <p>【17】 :Reset</p> <p>【18】 :Auto _ Run Mode----- (refer to Goup6)</p>

1、 03- 00~03- 04= **【0, 1】** External Run/Stop Control (refer to 00- 04)

A.2-wire mode1:

Example: 00- 04= **【0】** ; S1:03- 00= **【0】** (FWD/STOP); S2:03- 01= **【1】** (REV/STOP);

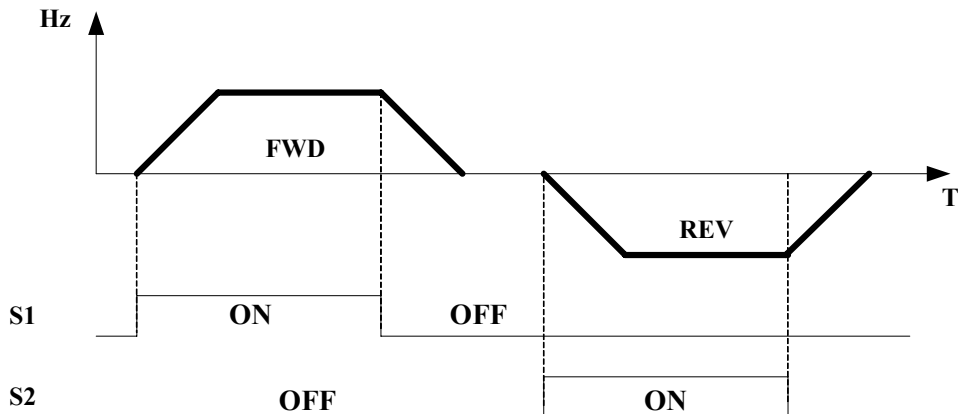
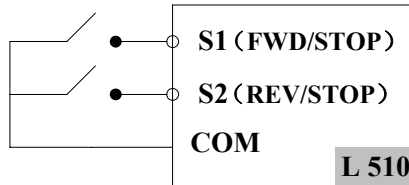

※Note: That both forward and reverse commands are ON will be treated as STOP.

B. 2-wire mode 2:

Example: 00-04=【1】; S1:03-00=【0】(RUN/STOP); S2:03-01=【1】(REV/FWD);

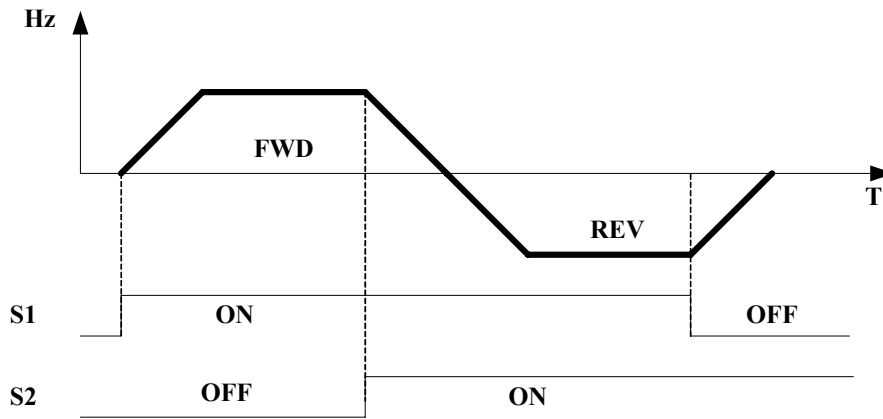
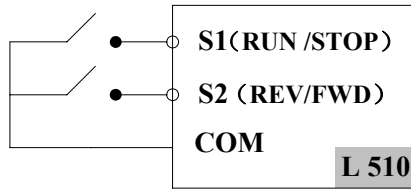

C.3-wire:

Example: 00-04=2, As 3 wire control mode is selected, the terminal S1, S2 and S3 is not controlled by 03-00, 03-01 and 03-02.

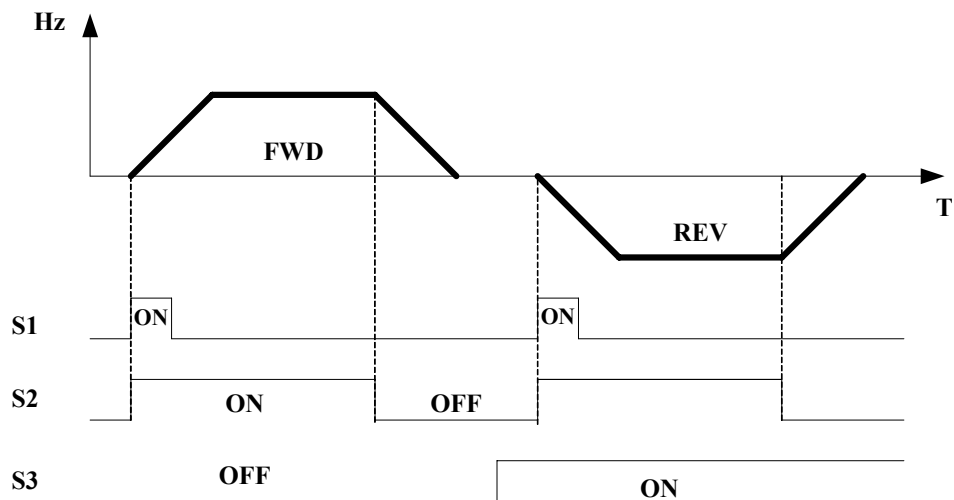
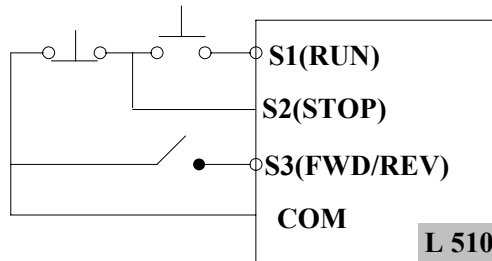

2、03- 00~03- 04= 【2, 3, 4】 Preset speed Function

Any three of terminals S1 ~ S5 decide which one of multi-speed command 0~7 is selected as a group, the frequency command, accelerating and decelerating time was set by parameter group 5, the specific timing diagram sees in description of group 5.

Preset speed	Function setting and state of any three (A, B, C) of terminal S1 ~ S5			Frequency	Acc-time	Dec-time
	terminal A=2	terminal B =3	terminal C =4			
speed 0	OFF	OFF	OFF	05- 01	05- 17	05-18
speed 1	OFF	OFF	ON	05- 02	05- 19	05-20
speed 2	OFF	ON	OFF	05- 03	05- 21	05-22
speed 3	OFF	ON	ON	05- 04	05- 23	05-24
speed 4	ON	OFF	OFF	05- 05	05- 25	05-26
speed 5	ON	OFF	ON	05- 06	05- 27	05-28
speed 6	ON	ON	OFF	05- 07	05- 29	05-30
speed 7	ON	ON	ON	05- 08	05- 31	05-32

3、03- 00~03- 04= 【6, 7】 Forward/ Reverse JOG

A terminal with a function of 【6】 is turned on, inverter works in jog forward mode.

A terminal with a function of 【7】 is turned on, inverter works in jog reverse mode.

Note: If jog forward and jog reverse function is enabled at the same time, inverter works in stop mode.

4、03- 00~03- 04= 【8, 9】 UP/DOWN

A terminal with function 【8】 is turned on ,frequency command increases by 03 - 06 setting, while running if the terminal is turned on longer than a time of it, the frequency command increases continuously until the frequency upper limit.

A terminal with function 【9】 is turned on , frequency command decreases by 03 - 06 setting, while running if the terminal is turned on longer than a time of it, the frequency command decreases continuously until 0Hz. See description of parameter 03 - 06 and 03 - 07.

5、03- 00~03- 04= 【10】 Acc/Dec time 2

A terminal with function 【10】 is turned on ,the actual accelerating and decelerating time depends on accelerating and decelerating time 2 (00-16/00-17), and if it is turned off, depends on accelerating and decelerating time 1.

6、03- 00~03- 04= 【11】 Acc/Dec Disabled

A terminal with function 【11】 is turned on, accelerating and decelerating is prohibited, inverter works in constant speed mode, if it is turned off , accelerating and decelerating is allowed.

Example: Setting: Terminal S1 : 03-00 = 11 (prohibits accelerating and decelerating functions)

Timing diagram:

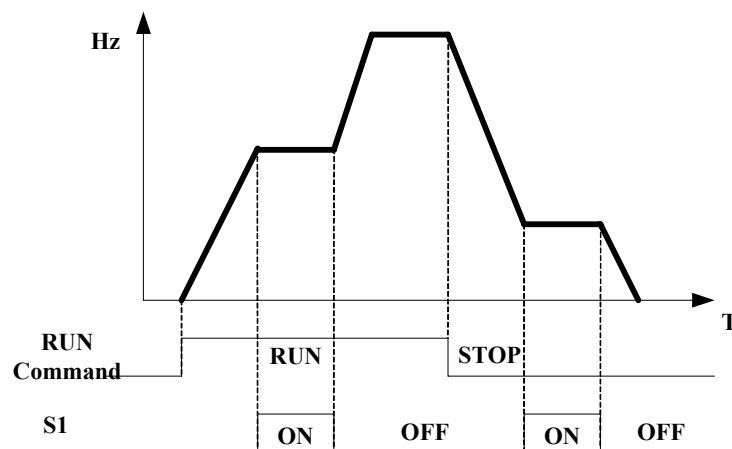

7、03- 00~03- 04= 【12】 Main/sub Control Signal Select

A terminal with function 【12】 is turned on, the operation command source is the setting of main operation command(00-03) .

8、03- 00~03- 04= 【13】 Main/sub Frequency Command Select

A terminal with function 【13】 is turned on, the operation command source is the setting of sub-operation command(00-06).

9、03-00~03-04=【14】Emergency Stop (controlled deceleration stop)

A terminal with function 【14】 is turned on, inverter stops preemptorily in decelerating stop mode.

10、03-00~03-04=【15】Base Block (Coast to stop)

A terminal with function 【15】 is turned on, inverter stops shieldlessly in free-run stop mode.

11、03-00~03-04=【16】PID Function Disabled

A terminal with function 【16】 is turned on, PID functions is disabled, if it is turned off, PID function is enabled.

12、03-00~03-04=【17】Reset

When a failure that can be manually reset occurs, turn on a terminal with function 【17】, the failure will be reset. (Same to Reset button).

13、03-00~03-04=【18】Auto Run Mode

Turn on a terminal with function 【18】, the programmable auto-operation function is enabled, see description of parameters group 6.

03-06	up/down frequency
Range	【0.00~5.00】 Hz

Example: S1: 03-00=【8】Up frequency command, S2: 03-01=【9】Down frequency command, 03-06=【△】Hz

mode1: If the terminal turns on for less than 2Sec, turning on once makes frequency changing Δ Hz

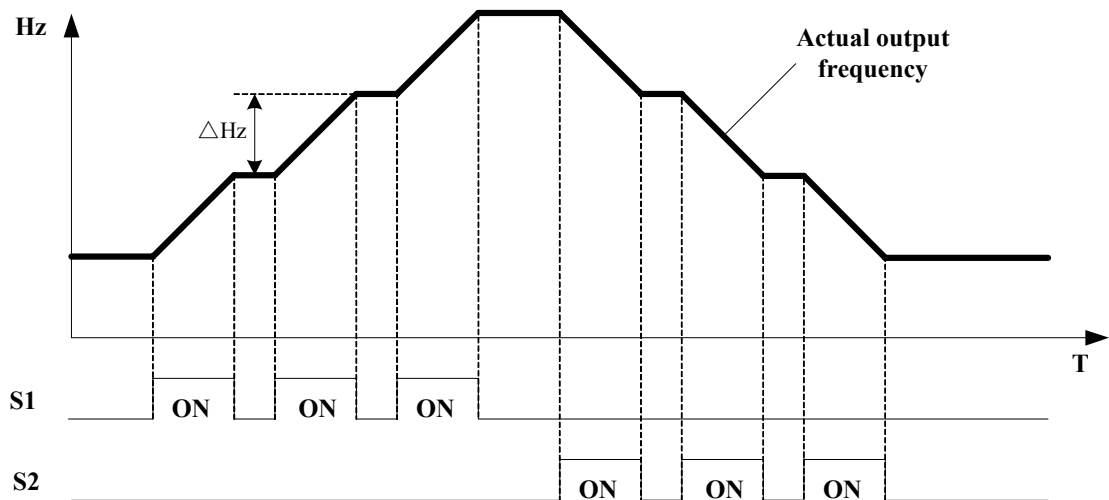

mode 2: If UP/DOWN is pressed over 2Sec, the original UP/DOWN mode is restored (Please refer to the following diagram)

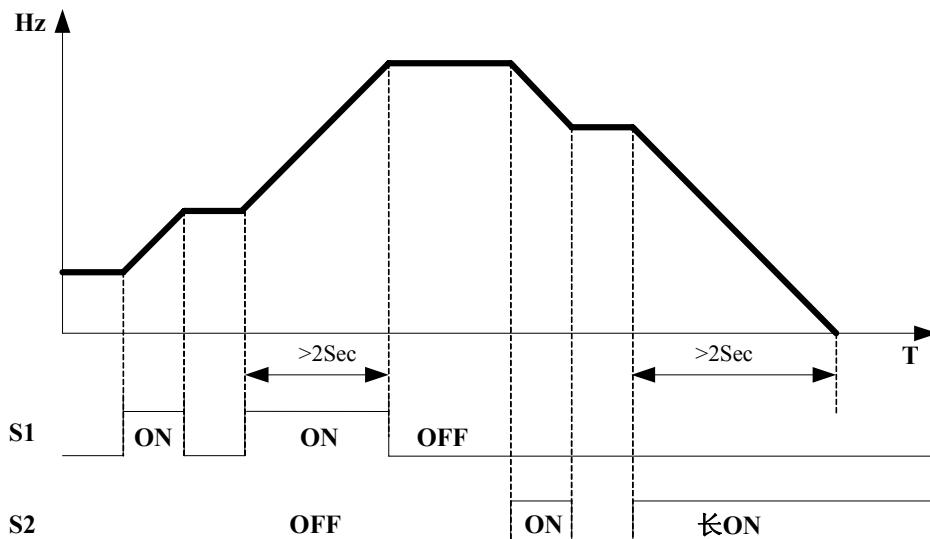

03- 07	Up/Down keep Frequency mode
Range	<p>【0】:When Up/Down is used, the preset frequency is held as the inverter stops,and the UP/Down function is disabled.</p> <p>【1】:When Up/Down is used, the preset frequency is reset to 0 Hz as the inverter stops.</p> <p>【2】:When Up/Down is used, the preset frequency is held as the inverter stops, and the UP/Down is available.</p>

- If 03 - 07 = **【0】** , inverter output frequency will be stored in 05-01 when run signal shuts off, and increase / decrease frequency key is invalid when inverter works in stop mode, to change the frequency setting you need to modify 05-01 with keypad; But if 03-07 = 2, stop when the increase / decrease frequency key is effective when inverter works in stop mode.
- Set 03 - 07 = **【1】** , inverter will always output beginning with 0Hz, increase / decrease frequency key works in the same way described above, when run signal shuts off, inverter stops output, and frequency command always turns back to 0Hz, therefore inverter will still output beginning with 0Hz the next time.

03- 08	Multifunction terminal S1~S5 confirm the scan times
Range	【1~200】 1mSec

- TM2 terminal is used for scanning. If there are the same signals continuously input for N times, the inverter will treat the signal as normal. During the signal evaluation, if the scan times are less than N, the signal will be treated as noise.
- Each scan period is 1ms.
- The user can specify the scan times interval duration according to the noise environment. If the noise is serious, increase the value of 03-08, however the response will be slower.

03- 09	s1~s5 switch type select
Range	<p>【xxxx0】 :S1 NO 【xxxx1】 :S1 NC</p> <p>【xxx0x】 :S2 NO 【xxx1x】 :S2 NC</p> <p>【xx0xx】 :S3 NO 【xx1xx】 :S3 NC</p> <p>【x0xxx】 :S4 NO 【x1xxx】 :S4 NC</p> <p>【0xxxx】 :S5 NO 【1xxxx】 :S5 NC</p>

- ※Note: “NO”: Normal open, “NC”: Normal close.
- The switches type is decided by 03-09,Because of different types of switches, select switches type is necessary.
- If set 03-09=0 0 0 0 0, means S1~S5 types of switches is Normal open, otherwise, if each bit of 03-09 is set to “1”, types of switches is Normal close.
- Don't set 00-02/00-03=1 , before you set 03-09 (external terminal controlled)

03-11	Output Relay RY Operation Mode (RB,RA terminal)
Range	<p>【0】 :Run</p> <p>【1】 :Fault</p> <p>【2】 :Frequency Reached------(refer to 03-13/03-14)</p> <p>【3】 :Set Frequency (3-13±3-14) -----(refer to 03-13/03-14)</p> <p>【4】 :Frequency Threshold Level (> 03-13) - Frequency Reached ---(refer to 03-13/03-14)</p> <p>【5】 :Frequency Threshold Level (< 03-13) - Frequency Reached ---(refer to 03-13/03-14)</p> <p>【6】 :Auto-restart</p> <p>【7】 :Momentary AC Power Loss------(refer to 07-00)</p> <p>【8】 :Emergency Stop Mode</p> <p>【9】 :Base Block Stop Mode</p> <p>【10】 :Motor Overload Protection OL1)</p> <p>【11】 :Drive Overload Protection (OL2)</p> <p>【13】 :Current Reached------(refer to 03-15/03-16)</p> <p>【14】 :Brake Control (DesiredFrequency Attained) -----(refer to 03-17/03-18)</p>

03-13	Frequency Reached Output Setting
Range	【0.00~650.00】 Hz
03-14	Frequency Detection Range (\pm)
Range	【0.00~30.00】 Hz

2. When 03-11 = **【1】**, if failure occurs, relay RY1 act

3. If 03-11 = **【2】**, When inverter actual output frequency reaches frequency command, relay RY1 act.

Actual output frequency=(Set frequency-03-14), RY1 output

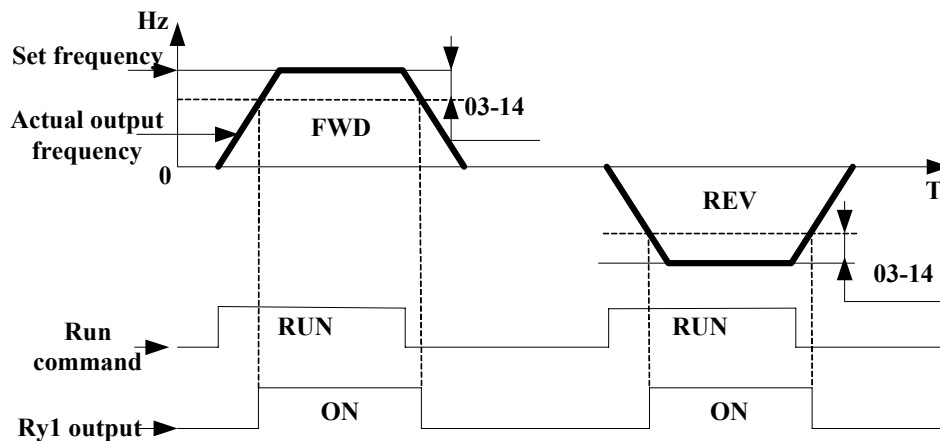

4. If 03-11 = **【3】**, When inverter actual output frequency reaches the arbitrary frequency setting (03 - 13 +/- 03-14 setting), relay RY1 act.

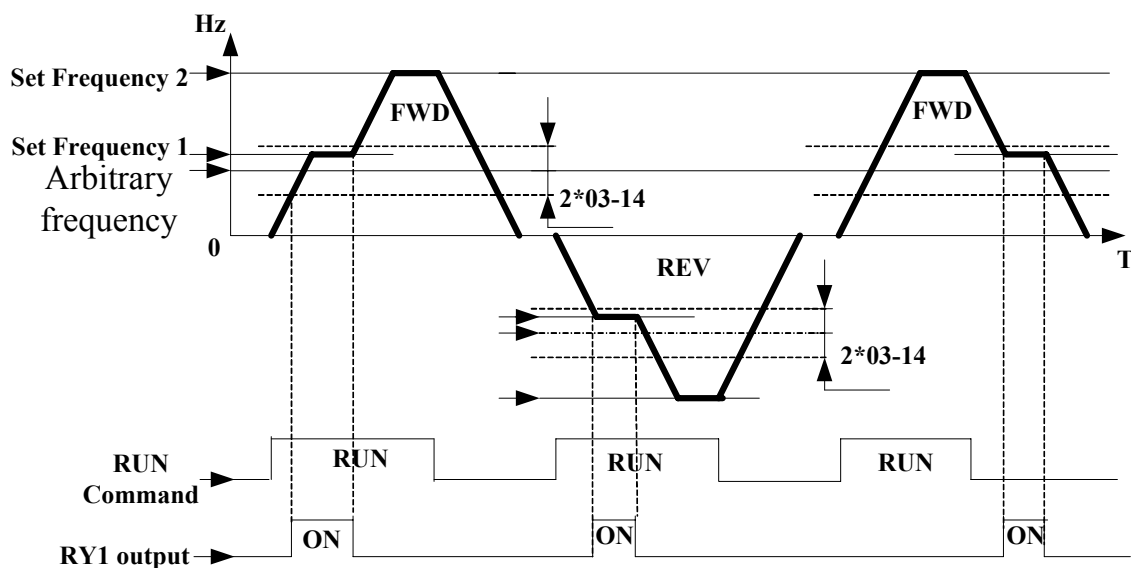

5. 03-11 = **【4】**, Frequency detection $F_{out} > 03-13$

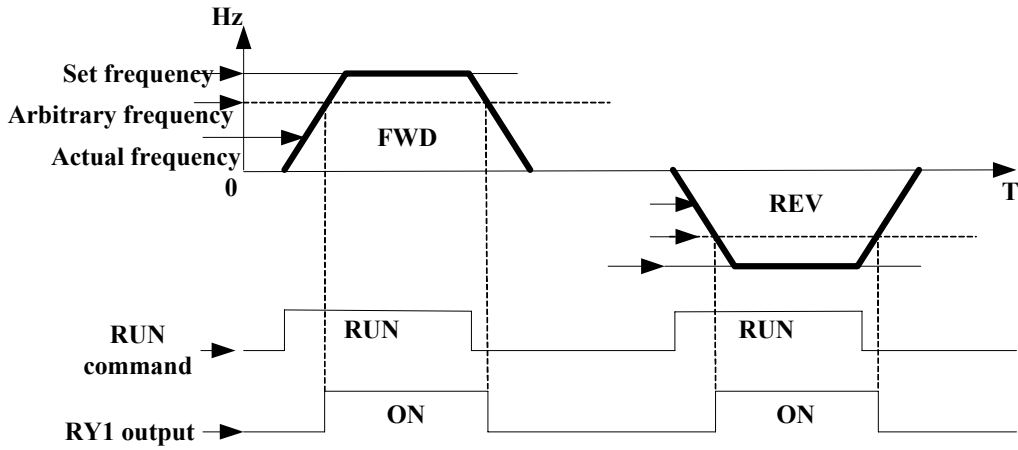

6、03-11=【5】，Frequency detection Fout < 03-13

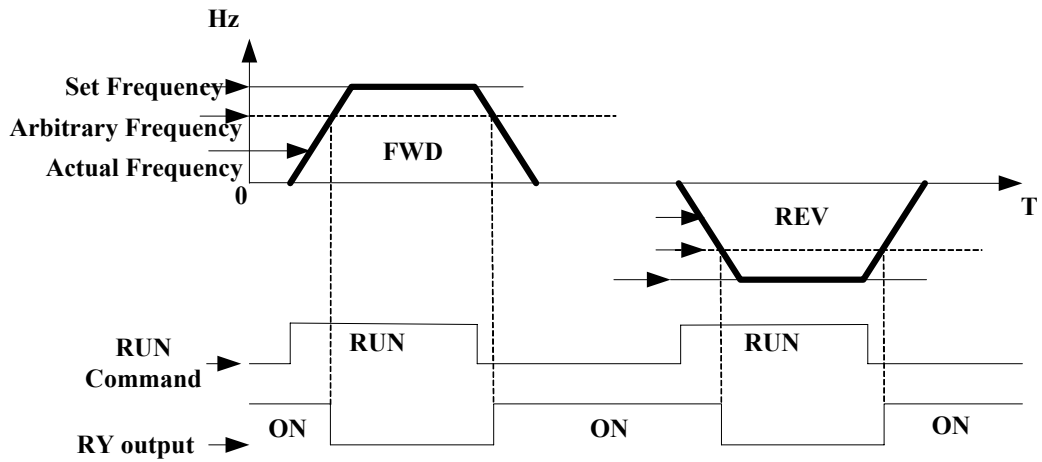

03-15	Output current Reached Level
Range	【0.1~15.0】 A
03-16	Output current detection time
Range	【0.1~10.0】 Sec

- 03-11=12: Output current detection value > 03-15, relay output.
- 03-15: Setting value (0.1~15.0) by motor rated current.
- 01-16: Setting value(0.1~10.0) unit: sec.

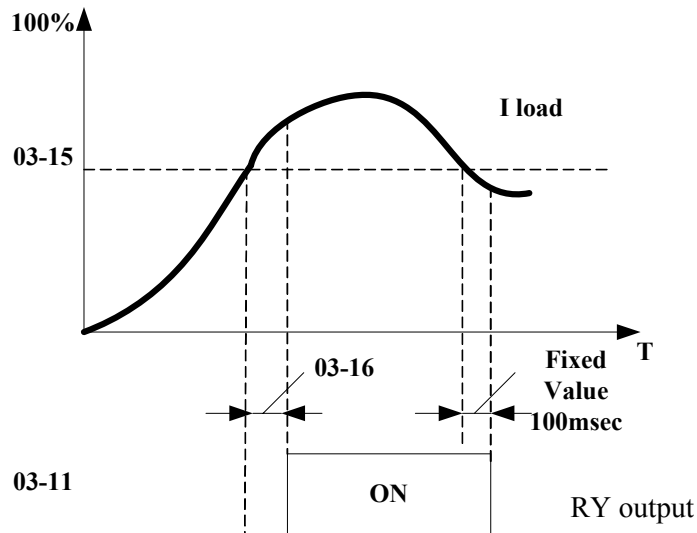

03-17	Brake Release Level
Range	【0.00~20.00】 Hz
03-18	Brake Engage Level
Range	【0.00~20.00】 Hz

- If 03-11 = 13, in accelerating mode, when inverter actual frequency reaches 03-17 mechanical brake release frequency, the relay act;
- In decelerating mode, when inverter actual frequency reaches 03-18 mechanical brake action frequency, the relay stops acting;

When 03-17 < 03-18, the timing diagram is shown as below:

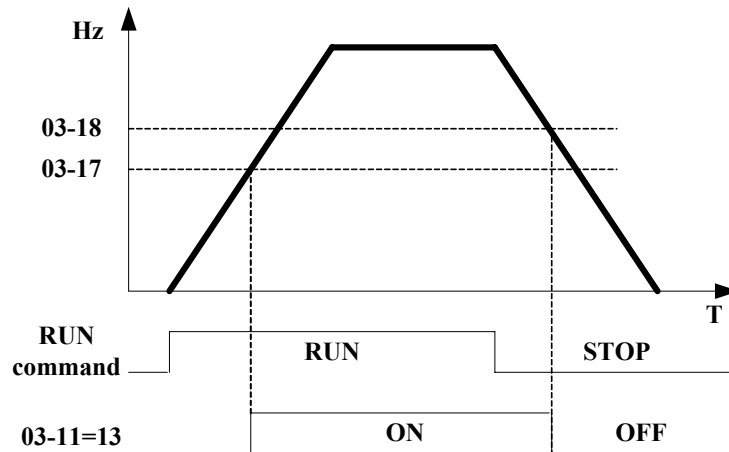

When 03-17 > 03-18, the timing diagram is shown as below:

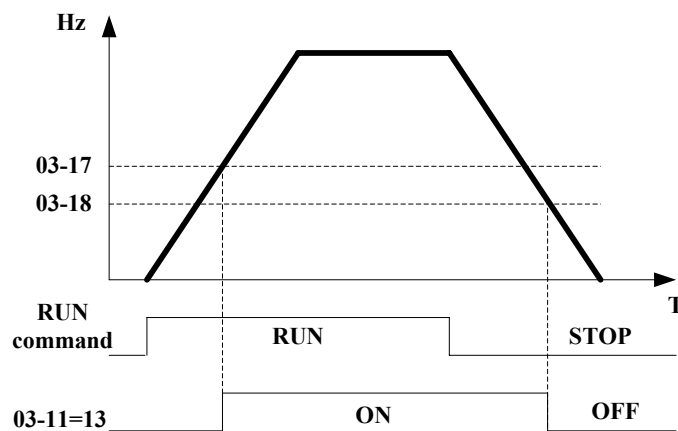

03- 19	Relay Output format
Range	【0】 :A (Normal open) 【1】 :B (Normal close)

04- External terminal analog signal input (output)function group

04- 00	AVI/ACI analog Input signal type select	
Range	AVI	ACI
	【0】 :0~10V	0~20mA
	【1】 :0~10V	4~20mA
	【2】 :2~10V	0~20mA
	【3】 :2~10V	4~20mA

- AVI(0~10V), ACI(0~20mA)

$$\text{AVI}(0\sim 10\text{V}): F(\text{Hz}) = \frac{V(\text{v})}{10(\text{v})} \times (00 - 12); \quad \text{ACI}(0\sim 20\text{mA}): F(\text{Hz}) = \frac{I(\text{mA})}{20(\text{mA})} \times (00 - 12)$$

- AVI(2~10V), ACI(4~20mA)

$$\text{AVI}(2\sim 10\text{V}): F(\text{Hz}) = \frac{V - 2(\text{v})}{10 - 2(\text{v})} \times (00 - 12), V \geq 2;$$

$$\text{ACI}(4\sim 20\text{mA}): F(\text{Hz}) = \frac{I - 4(\text{mA})}{20 - 4(\text{mA})} \times (00 - 12), I \geq 4;$$

04- 01	AVI signal verification Scan Time
Range	【1~200】 1msec
04- 02	AVIGain
Range	【0 ~ 1000】 %
04- 03	AVI Bias
Range	【0~ 100】 %
04- 04	AVI Bias Selection
Range	【0】 : positive 【1】 : Negative
04- 05	AVI Slope
Range	【0】 : positive 【1】 : Negative
04- 06	ACI signal verification Scan Time
Range	【1~200】 1msec
04- 07	ACIGain
Range	【0 ~ 1000】 %
04- 08	ACI Bias
Range	【0 ~ 100】 %
04- 09	ACI Bias Selection
Range	【0】 : positive 【1】 : Negative
04-10	ACI Slope
Range	【0】 : positive 【1】 : Negative

- 04- 01/04- 06 signal verification Scan Time:

The inverter reads the average value of A/D signals once per(04- 01/04- 06 x 1ms). Set scan intervals according to possible noise interference in the environment. Increase 04- 01/04- 06 in an environment with noise interference, but the response time will increase accordingly.

Take AVI (04-02~04-05) as an example to describe:

(1) Gain(04-02) is set to 100%, after setting offset(04-03), relation between voltage and frequency is shown below:

1) The setting of figure1:

	04- 02	04- 03	04- 04	04- 05
A	100%	50%	0	0
B	100%	0%	0	0

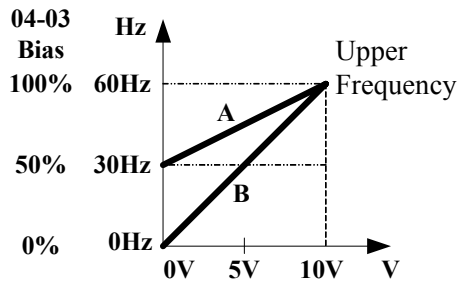

2) The setting of figure2:

	04- 02	04- 03	04- 04	04- 05
C	100%	50%	0	1
D	100%	0%	0	1

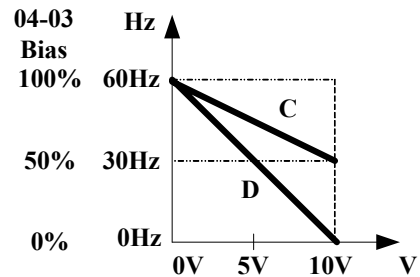

3) The setting of figure3:

	04- 02	04- 03	04- 04	04- 05
E	100%	20%	1	0

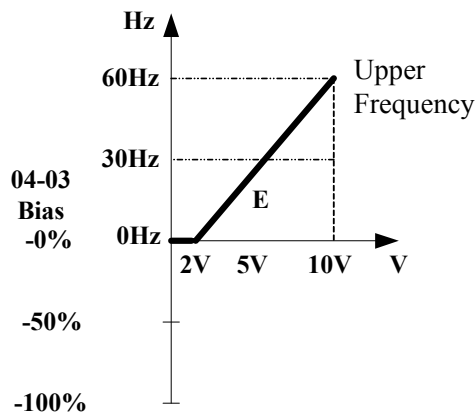

4) The setting of figure4:

	04- 02	04- 03	04- 04	04- 05
F	100%	50%	1	1

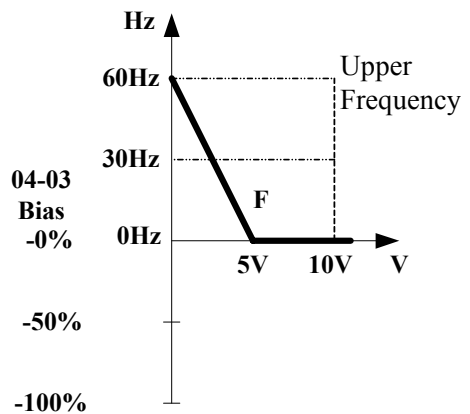

(2) Gain(04-03) is set to 0%, after setting offset(04-02), relation between voltage and frequency is shown below:

5) The setting of figure5:

	04- 02	04- 03	04- 04	04- 05
A'	50%	0%	0/1	0
B'	200%	0%	0/1	0

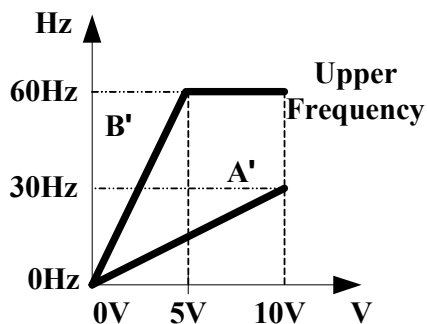

6) The setting of figure6:

	04- 02	04- 03	04- 04	04- 05
C'	50%	0%	0/1	1
D'	200%	0%	0/1	1

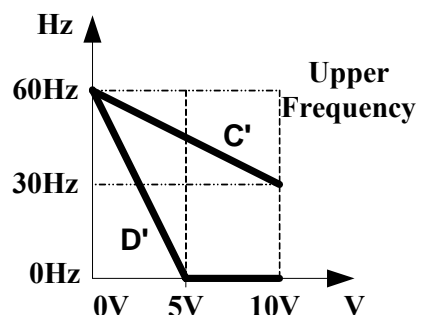

(3) Gain(04-02) is not set to 100%, after setting offset(04-03), relation between voltage and frequency is shown below:

7) The setting of figure7:

	04- 02	04- 03	04- 04	04- 05
a	50%	50%	0	0
b	200%	50%	0	0

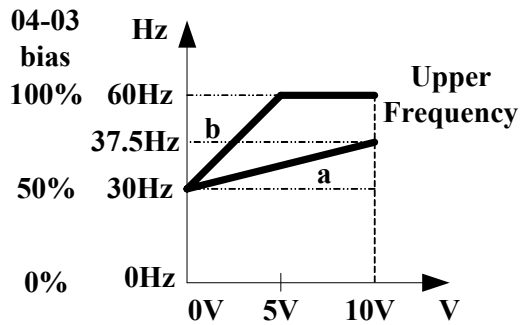

8) The setting of figure8:

	04- 02	04- 03	04- 04	04- 05
c	50%	50%	0	1
d	200%	50%	0	1

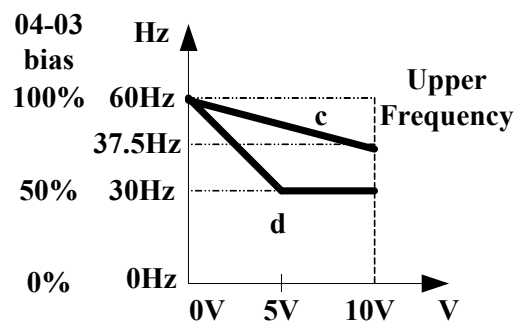

9) The setting of figure9:

	04- 02	04- 03	04- 04	04- 05
e	50%	20%	1	0
f	200%	20%	1	0

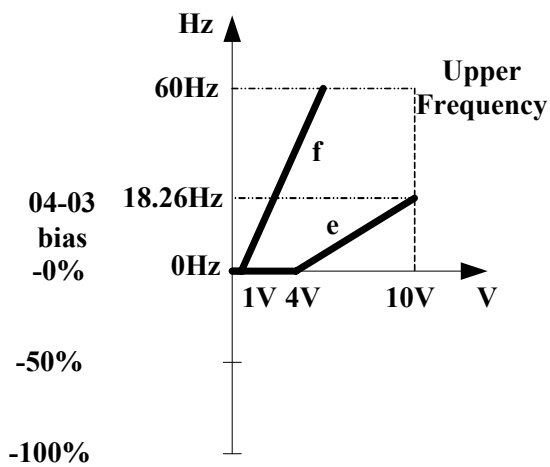

10) The setting of figure10:

	04- 02	04- 03	04- 04	04- 05
g	50%	50%	1	1
h	200%	0%	0	1

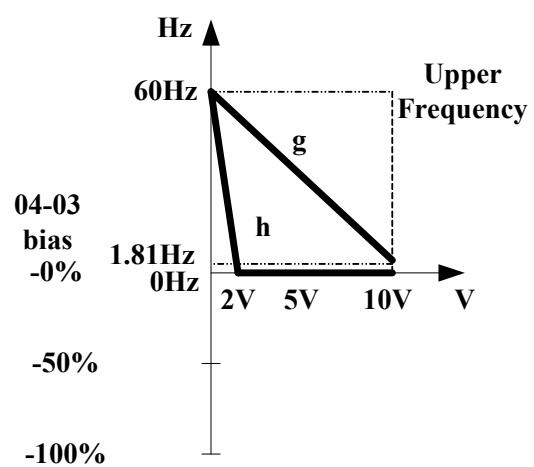

04-11	Analog Output (AO) Mode
Range	【0】 :Output frequency 【1】 :Frequency Setting 【2】 :Output voltage 【3】 :DC Bus Voltage 【4】 :Output current

Example:when 04-11=0,“A” stand for Output frequency, “Xmax”stand for upper frequency limit.

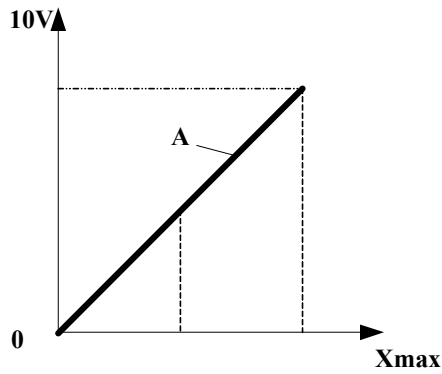

04-11	A	Xmax
【0】	Output frequency	upper frequency limit
【1】	Frequency Setting	upper frequency limit
【2】	Output voltage	Motor Rated Voltage
【3】	DC Bus Voltage	220V: 0~400V
【4】	Output current	2 times rated current of inverter

04-12	AO Gain
Range	【0 ~ 1000】 %
04-13	AO Bias
Range	【0 ~ 100】 %
04-14	AO Bias Selection
Range	【0】 : positive 【1】 : Negative
04-15	AO Slope
Range	【0】 : positive 【1】 : Negative

➤ AO: 04-12~04-15 function the same as AVI (04-02~04-05)。

The multifunction analog output terminal of the terminal block (TM2), is 0~10Vdc analog output. The output type is determined by the 04-11. The output voltage level can be scaled by parameter 04-12 to suit external meters and peripherals.

Note: the max output voltage is 10V due to hardware of the circuit. Use only devices that require a maximum of 10V signal.

05- Preset Frequency function group

05- 00	Preset Speed Control mode Selection
Range	【0】 :common Is uniform time(Acc1/Dec1or Acc2/Dec2) 【1】 :Special (is single time Acc0/Dec0~ Acc7/Dec7)

05- 01	Preset Speed 0 (Keypad Freq)
05- 02	Preset Speed 1
05- 03	Preset Speed 2
05- 04	Preset Speed 3
05- 05	Preset Speed 4
05- 06	Preset Speed 5
05- 07	Preset Speed 6
05- 08	Preset Speed 7
Range	【0.00 ~ 650.00】 Hz
05-17	Preset Speed 0 Acceleration time
05-18	Preset Speed 0 Deceleration time
05-19	Preset Speed 1 Acceleration time
05- 20	Preset Speed 1 Deceleration time
05- 21	Preset Speed 2 Acceleration time
05- 22	Preset Speed 2 Deceleration time
05- 23	Preset Speed 3 Acceleration time
05- 24	Preset Speed 3 Deceleration time
05- 25	Preset Speed 4 Acceleration time
05- 26	Preset Speed 4 Deceleration time
05- 27	Preset Speed 5 Acceleration time
05- 28	Preset Speed 5 Deceleration time
05- 29	Preset Speed 6 Acceleration time
05- 30	Preset Speed 6 Deceleration time
05- 31	Preset Speed 7 Acceleration time
05- 32	Preset Speed 7 Deceleration time
Range	【0.1 ~ 3600.0】 Sec

- When 05- 00 = **【0】** ,Acc-time (Dec-time) is determined by the 00-14/00-15(or 00-16/00-17).
- When 05- 00 = **【1】** ,Acc-time (Dec-time) is determined by the 05-17~05- 32.

➤ Function Description:

- Formula for calculating acceleration and deceleration time:

$$\text{Actual Acc time} = \frac{\text{Acc time of group 0} \times \text{Preset Frequency}}{\text{Maximum Frequency}}$$

$$\text{Actual Dec time} = \frac{\text{Dec time of group 0} \times \text{Preset Frequency}}{\text{Maximum Frequency}}$$

- 01- 00= **【7】** ,Maximum output frequency =01-02 setting
- 01- 00≠ **【7】** ,Maximum output frequency =50.00(or 60.00)

Example : 01- 00≠ **【7】** ,01- 02= **【50】** hz, 05- 02= **【10】** hz(preset speed1),
05-19= **【5】** s(Acc-time),05-20= **【20】** s(Dec-time)

$$\text{Preset speed 1 Actual Acc time} = \frac{(05-19) \times 10(\text{hz})}{01-02} = 1(\text{s})$$

$$\text{Preset speed 1 Actual Dec time} = \frac{(05-20) \times 10(\text{hz})}{01-02} = 4(\text{s})$$

➤ When 05-00= **【1】** ,the time has two modes to be set

Example: 00- 02= **【1】** (External Run/Stop Control); S1: 03- 00= **【0】** (RUN/STOP);
 S2: 03- 01= **【1】** (forward/reserve); S3: 03- 02= **【2】** (preset speed 1);
 S4: 03-03= **【3】** (preset speed 2); S5: 03-03= **【4】** (preset speed 4);

model:

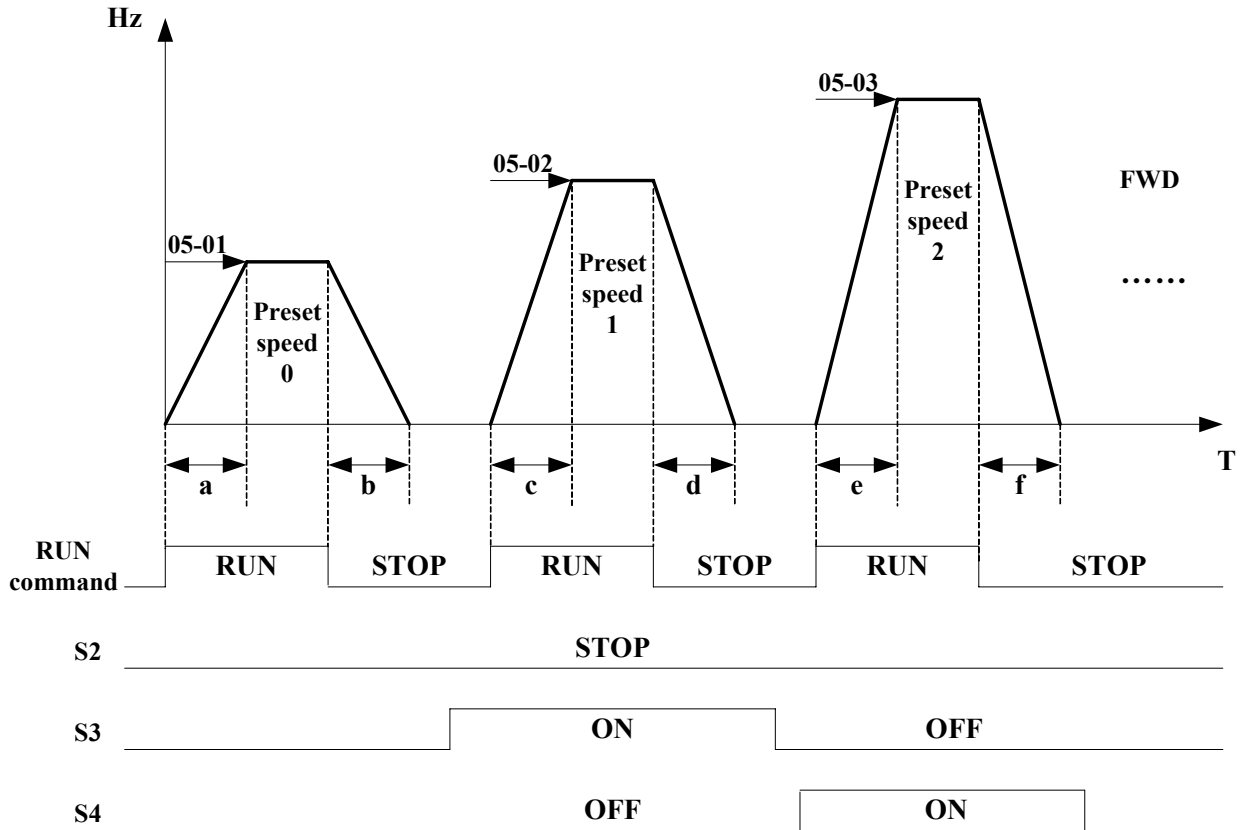

When the run command is uncontinuous, calculate acceleration and deceleration time of each segment like this

$$a = \frac{(05-17) \times (05-01)}{01-02}, b = \frac{(05-18) \times (05-01)}{01-02}, c = \frac{(05-19) \times (05-02)}{01-02}, d = \frac{(05-20) \times (05-02)}{01-02} \dots$$

Unit (sec)

mode 2:

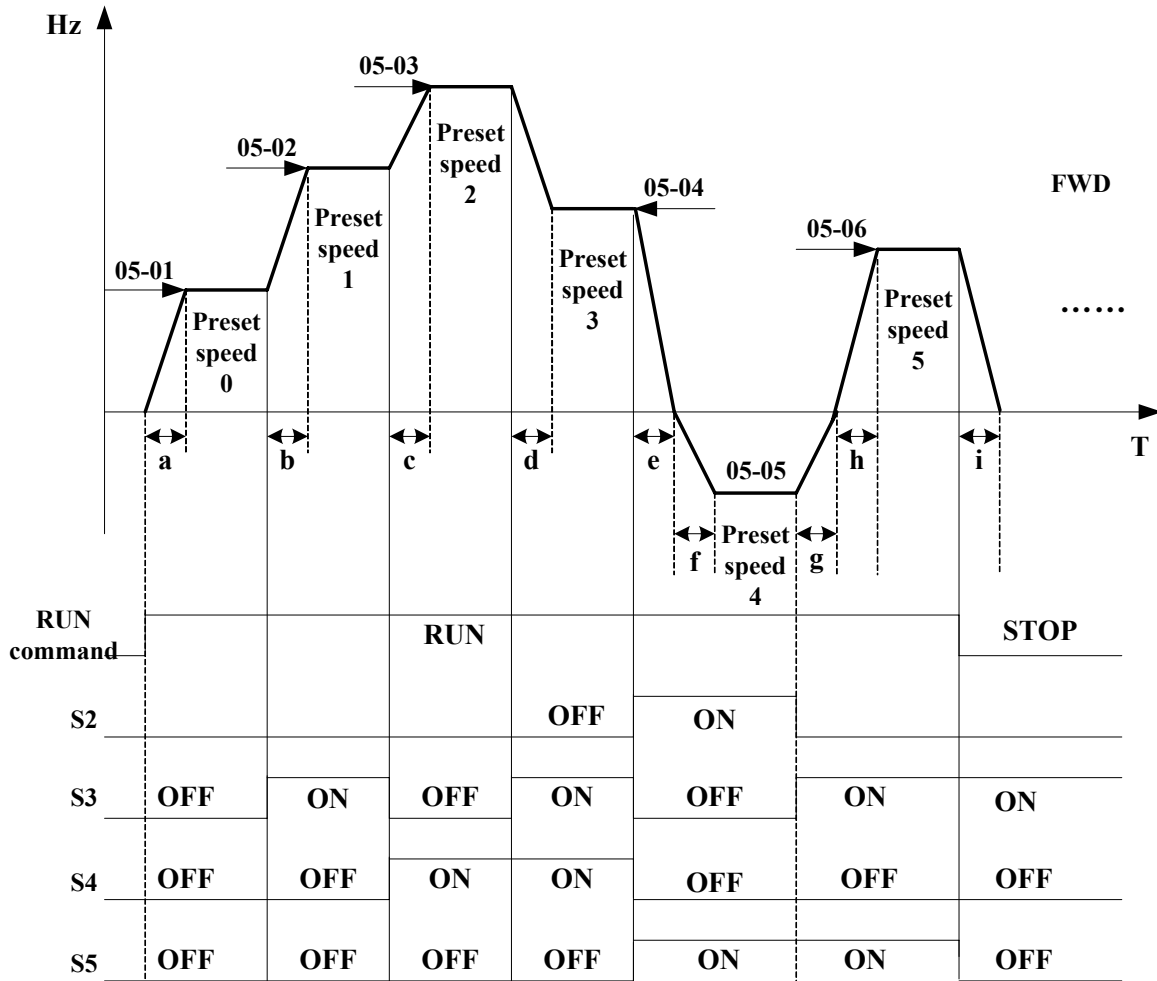

When the run command is continuous, calculate acceleration and deceleration time of each segment like this

$$a = \frac{(05-17) \times (05-01)}{01-02}, \quad b = \frac{(05-19) \times [(05-02) - (05-01)]}{01-02}, \quad c = \frac{(05-21) \times [(05-03) - (05-02)]}{01-02}$$

$$d = \frac{(05-24) \times [(05-03) - (05-04)]}{01-02}, \quad e = \frac{(05-26) \times (05-05)}{01-02}, \quad f = \frac{(05-25) \times (05-05)}{01-02},$$

$$g = \frac{(05-28) \times (05-05)}{01-02}, \quad h = \frac{(05-27) \times (05-05)}{01-02}, \quad i = \frac{(05-28) \times (05-05)}{01-02} \dots \text{Unit (sec)}$$

(A) Single Cycle Running (06- 00=1,4)

The inverter will run for a single full cycle based upon the specified setting mode. Then, it will stop.

For example: 06- 00= **【1】** (or **【4】**),

Panel Frequency (05-01)= **【15】** Hz, 06- 01= **【30】** Hz, 06- 02= **【50】** Hz, 06- 03= **【20】** Hz

06-16= **【20】** s, 06-17= **【25】** s, 06-18= **【30】** s 06-19= **【40】** s,

06-32= **【1】** , 06-33= **【1】** , 06-34= **【1】** (FWD), 06-35= **【2】** (REV),

06-04~06-07= **【0】** Hz, 06-20~06-23= **【0】** s, 06-36~06-39= **【0】**

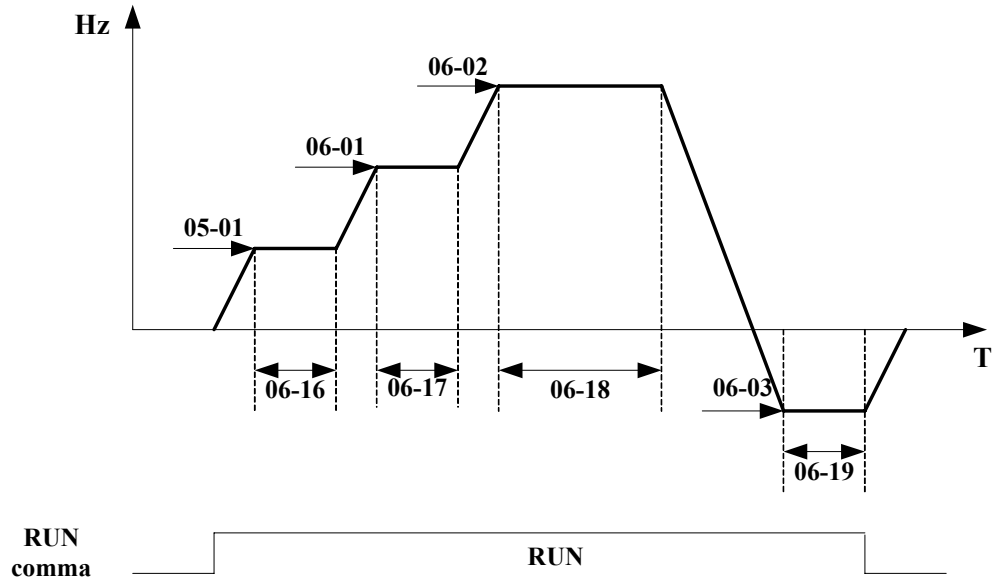

(B) Periodic cycle Running (06- 00=2,5)

The inverter will repeat the same cycle periodically.

For example:

06- 00= **【2】** (or **【5】**) 06- 01~13-03,06- 08~13-11,

06-16~06-19: Same setting as the example (A)

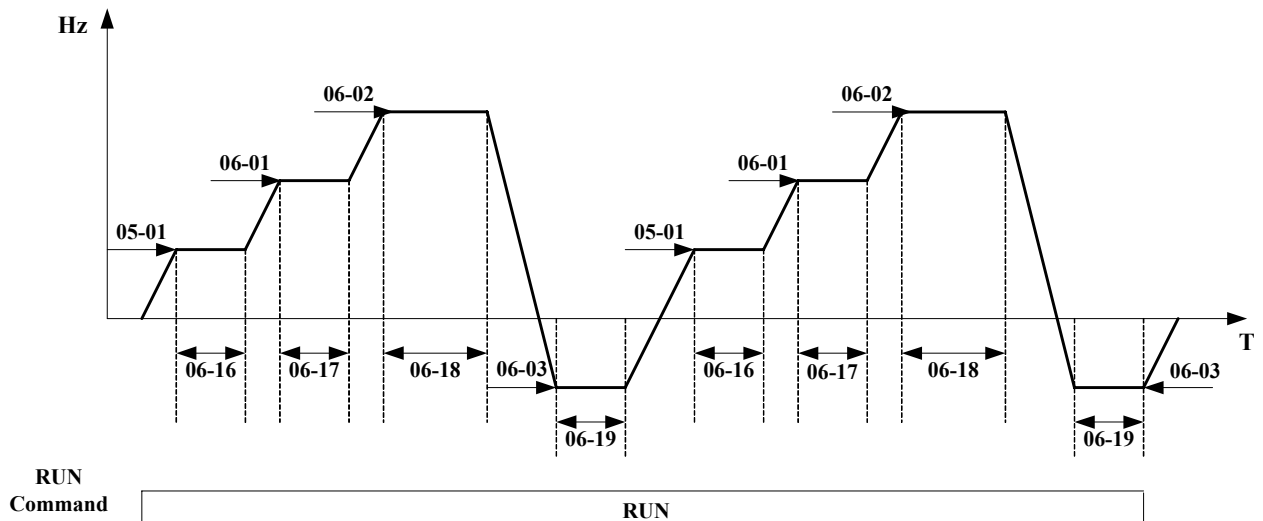

(C)Auto_Run Mode for Single Cycle (06-00= 【3,6】)

The speed of final step will be held to run.

For example: 06- 00 = 【3】 (or 【6】),

Panel Frequency (05- 01)= 【15】 Hz, 06- 01= 【30】 Hz, 06- 02= 【50】 Hz, 06- 07= 【20】 Hz,
 06-16= 【20】 s, 06-17= 【25】 s, 06-18= 【30】 s, 06-23= 【40】 s,
 06-32= 【1】 , 06-33= 【1】 , 06-34 = 【1】 , 06-39= 【1】 (FWD),
 06-03~06- 06= 【0】 Hz , 06-19~06-22= 【0】 s , 06-35~06-38 = 【0】

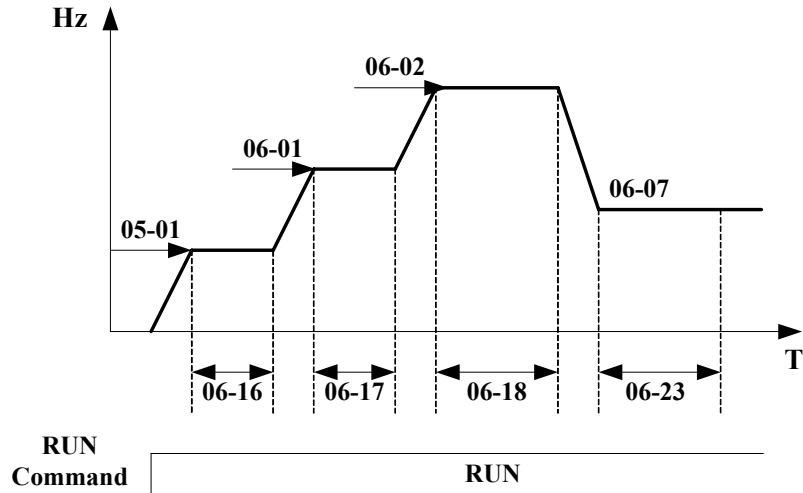

- 06- 00=【1~3】 , If the inverter stops and re-starts, it will continue running from the unfinished step, according to the setting of 06- 00.
- 06- 00= 【4~6】 , If the inverter stops and re-starts, it will begin a new cycle and continue running according to the setting of 06- 00.

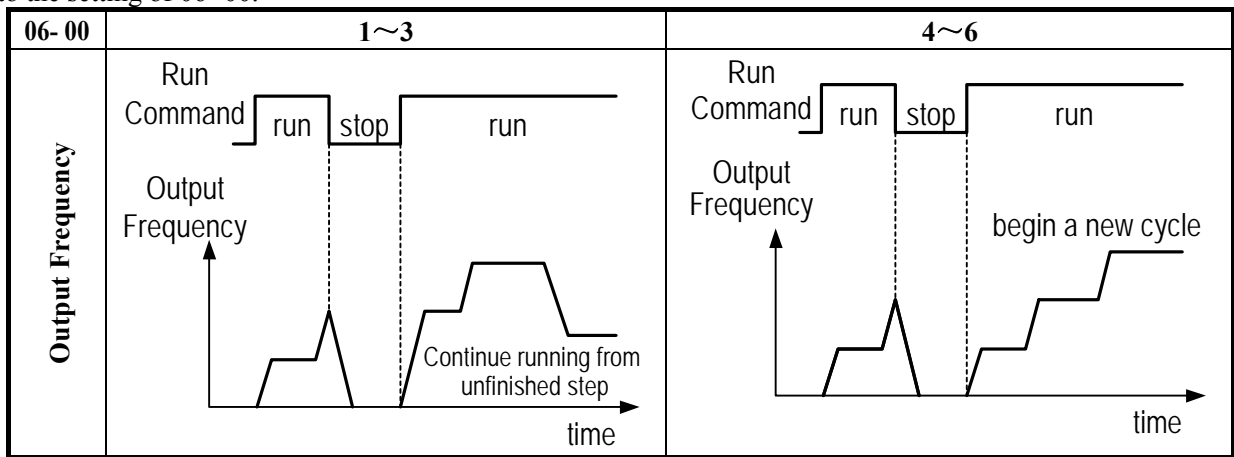

ACC/DEC time follow the setting of 00-14/00-15 or 00-16/00-17 in Auto Run Mode.

note:06-16 and 06-32 should be used in company with panel setting frequency(05-01) as the 0 step of atuo programable run.

07- Start/Stop command group

07- 00	Momentary power loss and restart
Range	【0】 :Momentary Power Loss and Restart disable 【1】 :Momentary power loss and restart enable

- If the input power supply due to sudden increase in supply demand by other equipment results in voltage drops below the under voltage level, the inverter will stop output at once.
- When 07- 00= **【0】** : as power lost, the inverter will not start.
- When 07 - 00 = **【1】** , after a instantaneous stop, inverter will restart in speed search mode, and times of restarting is not limited.
- the power lost for long time, before the inverter lost the control power for the CPU, the inverter will restart according to the 00-02 and 07-04 setting and status of external switch as the resumed..

Note: 00-02=1 07-04=0 after a power loss for a long time, please turn OFF the power and power switches to avoid any possible injury to operators and machines when the power is resumed unexpectedly.

07- 01	Auto Restart Delay Time
Range	【0.0~800.0】 Sec
07- 02	Number of Auto Restart Attempts
Range	【0~10】

- 07- 02= **【0】** : The inverter will not auto restart after trips due to fault.
- 07- 02>**【0】** , 07- 01=**【0】**: The inverter will conduct SPIN START in 0.5 second after trips due to fault. The motor will Coast to stop while the output is switched off, Once the rotating speed is determined then it will accelerate or decelerate from this speed to the running speed before the fault.
- 07- 02>**【0】** , 07- 01>**【0】** The output will be stopped for a period which is determined by the 07-01 after a fault trip. Then, spin start to set target frequency.
- Auto restart after a fault will not function while DC injection braking or decelerating to stop

07- 03	Reset Mode Setting
Range	【0】 :Enable Reset Only when Run Command is Off 【1】 :Enable Reset when Run Command is On or Off

- 07-03=0 Once the inverter is detected a fault, please turn Run switch Off and then On again to perform reset, otherwise restarting will not be possible.

07- 04	Direct Running After Power Up
Range	【0】 :Enable Direct running after power up 【1】 :Disable Direct running after power up
07- 05	Delay-ON Timer (Seconds)
Range	【1.0~300.0】 Sec

- 07-04=0 and the inverter is set external terminal controlled (00-02/00-03=1) , if the run switch is ON as power is supplied, the inverter will auto start. It is recommend that the power is turned off and the run switch is also off to avoid possibility of injury to operators and machines as the power is reapplied.

Note: IF this mode is required all safety measures must be considered including warning labels.

- 07-04=1 and the inverter is set external terminal controlled (00-02/00-03=1) , if the run switch is ON as power is supplied, the inverter will not auto start and the display will flash with STP1.

It is necessary to turn OFF the run switch and then ON to start normally.

07- 06	DC Injection Brake Start Frequency (Hz) @Stopped
Range	【0.10 ~ 10.00】 Hz
07- 07	DC Injection Brake Level (%>@Stopped
Range	【0~ 20】 %
07- 08	DC Injection Brake Time (Seconds)@stopped
Range	【0.0 ~ 25.5】 Sec

➤ 07- 08 / 07- 06 is the action time and start frequency of DC braking, as graph below:

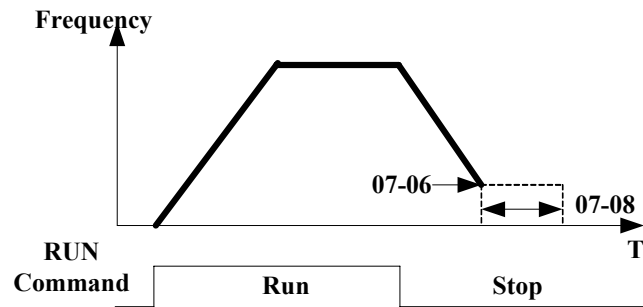

08- Protection function group

08- 00	Trip Prevention Selection
Range	【xxxx0】 :Enable Trip Prevention During Acceleration 【xxxx1】 :Disable Trip Prevention During Acceleration 【xxx0x】 :Enable Trip Prevention During Deceleration 【xxx1x】 :Disable Trip Prevention During Deceleration 【xx0xx】 :Enable Trip Prevention in Run Mode 【xx1xx】 :Disable Trip Prevention in Run Mode 【x0xxx】 :Enable over voltage Prevention in Run Mode 【x1xxx】 :Disable over voltage Prevention in Run Mode

08- 01	Trip Prevention Level During Acceleration
Range	【50 ~ 200】 %

- In acceleration, the inverter will delay the acceleration time if the time is too short resulting in the over current in order to prevent the inverter trips.

08- 02	Trip Prevention Level During Deceleration
Range	【50 ~ 200】 %

- In deceleration, the inverter will delay the deceleration time if the time is too short resulting in the over voltage of DC VUS in order to prevent the inverter trips with 'OV' displayed.

08- 03	Trip Prevention Level In Run Mode
Range	【50 ~ 200】 %

- Some mechanical characteristics (such as press) or unusual breakdown (seize due to insufficient lubrication, uneven operation, impurities of processed materials, etc.) will cause the inverter to trip, thus inconvenience users. When the operating torque of the inverter exceeds the setting of 08-03, the inverter will lower the output frequency following the deceleration time, and return to the normal operation frequency after the torque get steady.

08- 04	Over voltage Prevention Level in Run Mode
Range	【350~390】 V

- While inverter is running, if DC voltage gets larger than 08-04 setting, over voltage stall option will be executed.

08- 05	Electronic Motor Overload Protection Operation Mod (OL1)
Range	【0】 :Enable Electronic Motor Overload Protection 【1】 :Disable Electronic Motor Overload Protection

08- 06	Operation After Overload Protection is Activated
Range	【0】 :Coast-to-Stop After Overload Protection is Activated 【1】 :Drive Will Not Trip when Overload Protection is Activated (OL1)

- 08- 06 = **【0】** :the inverter coast to stop as the thermal relay acts and flash OL1. Press the 'Reset' or the external reset terminal to continue to run.
- 08- 06 = **【1】** :the inverter continues to run as the thermal relay acts and flash OL1. Until the current decline to A value,OL1 will disappear.
- Minute

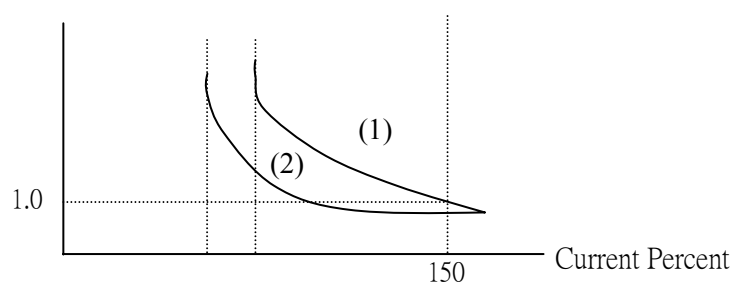

08- 07	OH over heat Protection
Range	【0】 :Auto (Depends on temp.) 【1】 :Operate while in RUN mode 【2】 :Always Run 【3】 :Disabled

- When **08- 07= 【0】** :The fan runs as the inverter senses temperature rises. Thusly, extend the service period.
- When **08- 07= 【1】** :The fan runs while the inverter is running.
- When **08- 07= 【2】** :The fan is continuously running regardless of the action of the inverter.
- When **08- 07= 【3】** ;The fan is **Disabled**.

08- 08	AVR function
Range	【0】 :AVR function enable 【1】 :AVR function disable 【2】 :AVR function disable for stop 【3】 :AVR function disable for Deceleration 【4】 :AVR function disable for stop and Deceleration 【5】 :when VDC>360V , AVR function disable for stop and Deceleration

- Automatic voltage regulator function is mainly to solve the problem that is the output voltage instability caused from the input voltage instability.
- 08-08=0 When the input voltage has fluctuating, the output voltage will not fluctuate with the input voltage changing.
- 08-08=1, When the input voltage fluctuates, the output voltage will vary with input voltage fluctuations.
- 08-08=2, AVR is invalid while “stop” of inverter at work only, to increase the speed of braking at this time.
- 08-08=3, AVR is invalid when the inverter slows down, from high speed to low speed only, it can be shortened the time of deceleration at this time.
- 08-08=4, AVR function disable for stop and deceleration.
- 08-08=5, when VDC>360V(200V), AVR function disable for stop and deceleration.

08- 09	Input phase lost protection
Range	【0】 :Disabled 【1】 :Enabled

09- Communication function group

09- 00	Assigned Communication Station Number
Range	【1 ~ 32】

- 09-00 to set the communication station codes which are suitable for driving more than one inverters situations.

09- 01	RTU code /ASCII code Selection
Range	【0】 :RTU 【1】 :ASCII
09- 02	Baud Rate Setting (bps)
Range	【0】 :4800 【1】 :9600 【2】 :19200 【3】 :38400
09- 03	Stop Bit Selection
Range	【0】 :1 stop bit 【1】 :2 stop bit
09- 04	Parity Selection
Range	【0】 :no parity 【1】 :odd parity 【2】 :even parity
09- 05	Data Format Selection
Range	【0】 :8 bit data 【1】 :7 bit data

- Set 09-01~09-05 to configure communication format before communicating.

09- 06	Communication time-out detection time
Range	【0.0~25.5】 Sec
09- 07	Communication time-out operation selection
Range	【0】 :Stop in decelerating time 1 and show COT after communication timeout 【1】 : Stop in free run mode and show COT after communication timeout 【2】 :Stop in decelerating time 2 and show COT after communication timeout 【3】 : Keep running and show COT after Communication timeout

- Time-out detection time: 00.0~25.5sec; setting 00.0 sec: disable time-out function.
- Option of communication timeout checkout: After communication timeout, inverter works as this parameter setting.

09- 08	Err6 fault tolerance times
Range	【1~20】

- When communication error times \geq 09-08 setting, display ERR6 on the keypad.

09- 09	Drive Transmit Wait Time
Range	【5~65】 mSec

- This parameter is used to set the converter This receive data from the sending date to the beginning of the time.

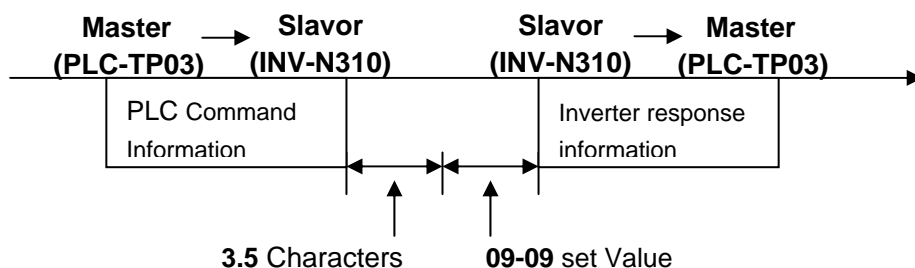

10-PID function group

PID block diagram

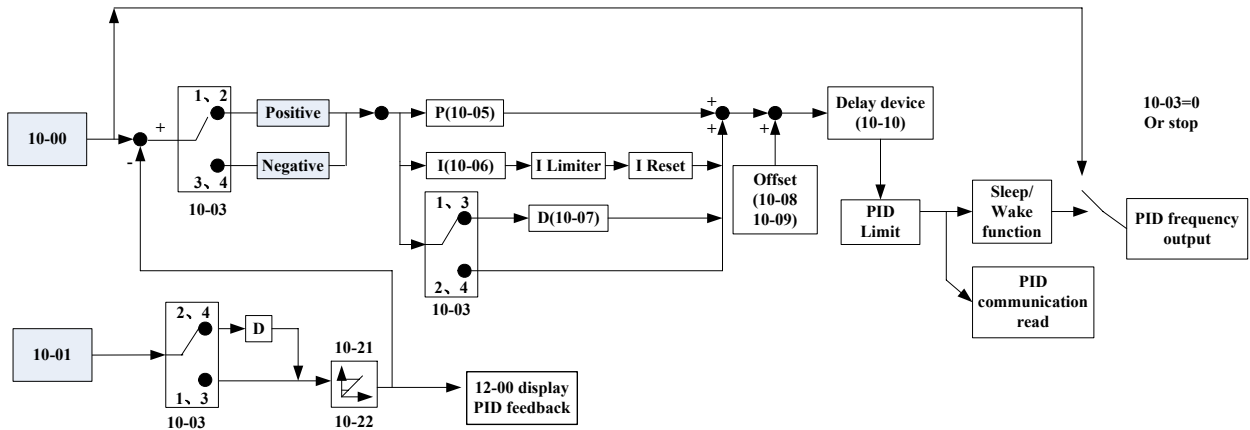

10- 00	PID target value selection
Range	【0】 :Potentiometer on Keypad 【1】 :External AVI Analog Signal Input 【2】 :External ACI Analog Signal Input 【3】 :Communication setting Frequency 【4】 :By 10-02

➤ This parameter is only used when 00 - 05 \ 00 - 06= 6.

10- 01	PID feedback value selection
Range	【0】 :Potentiometer on Keypad 【1】 :External AVI Analog Signal Input 【2】 :External ACI Analog Signal Input 【3】 :Communication setting Frequency

➤ ! Note: 10-00 and 10-01 can not be set the same value.

10- 02	PID keypad input
Range	【0.0~100.0】 %

10- 03	PID operation selection
Range	【0】 :PID Function disable 【1】 :Deviation is D-controlled 【2】 :Feedback D-controlled 【3】 :D Reverse characteristic controlled 【4】 :Feedback D characteristic controlled

- 10- 03 = **【1】** ,D is the deviation of (target value –detected value) in the unit time (10- 07) ◦
- 10- 03 = **【2】** , D is the deviation of the detected values in unit time (10- 07) ◦
- 10- 03 = **【3】** D is the deviation of (target value – detected value) in the unit time(10- 07). If the deviation is positive, the output frequency decreases, vice versa.
- 10- 03 = **【4】** D is the deviation of detected value in unit time (10- 07). When the deviation is positive, the frequency decreases, vice versa.

10- 04	Feedback Gain coefficient
Range	【0.00 ~ 10.00】

➤ 10-04 is the calibration gain. Deviation = set point –(feedback signal×10-04)

10- 05	Proportional Gain
Range	【0.0 ~ 10.0】 %

➤ 10- 05 : Proportion gain for P control.

10- 06	Integration Time
Range	【0.0 ~ 100.0】 Sec

➤ 10- 06 : Integrate time for I control

10-07	Differentiation Time
Range	【0.00 ~ 10.00】 Sec
➤	10-07 : Differential time for D control
10-08	PID Offset
Range	【0】 : Positive Direction 【1】 : Negative Direction
10-09	PID Offset Adjust
Range	【0 ~ 109】 %
➤	10-08 /10-09: Calculated PID output is offset by 10-09 (the polarity of offset is according to 10-08)
10-10	PID Output Lag Filter Time
Range	【0.0 ~ 2.5】 Sec
➤	10-10 : Update time for output frequency.
10-11	Feedback Loss Detection Mode
Range	【0】 :Disable 【1】 :Enable – Drive Continues to Operate After Feedback Loss 【2】 :Enable – Drive “STOPS” After Feedback Loss
➤	10-11= 【0】 :Disable; 10-11= 【1】 :detect, continue running, and display ‘PDER’;
➤	10-11= 【2】 :detect, stop, and display ‘PDER’.
10-12	Feedback Loss Detection Level
Range	【0 ~ 100】
➤	10-12 is the level for signal loss. Error = (Set point – Feedback value). When the error is larger than the loss level setting, the feedback signal is considered lost.
10-13	Feedback Loss Detection Delay Time
Range	【0.0 ~25.5】 Sec
➤	10-13:The minimum time to consider the feedback signal lost.
10-14	Integration Limit Value
Range	【0 ~ 109】
➤	10-14: the Limiter to prevent the PID from saturating.
10-15	Integration Value Resets to Zero when Feedback Signal Equals the Intended Value
Range	【0】 :Disable 【1】 :1 Sec 【30】 :30 Sec 1 ~ 30 Sec
➤	10-15=0 , As PID feedback value reaches the set point, the integrator will not be reset to 0.
➤	10-15=1~30: As PID feedback value reaches the set point, reset to 0 in 1~30 seconds and inverter stops. The inverter will run again when the feedback value differs from the set point value.
➤	
10-16	Allowable Integration Error Margin (Unit) (1 Unit = 1/8192)
Range	【0 ~ 100】
➤	10-16=0 ~ 100% unit value: Restart the tolerance after the integrator reset to 0.
10-17	PID Sleep Frequency Level
Range	【0.00~650.00】 Hz
10-18	PID Sleep Function Delay Time
Range	【0.0 ~25.5】 Sec
10-19	PID Wake up frequency Level
Range	【0.00 ~ 650.00】 Hz
10-20	PID Wake up function Delay Time
Range	【0.0 ~ 25.5】 Sec
➤	When PID output frequency is less than the sleep threshold frequency and exceeds the time of sleep delay, the inverter will decelerate to 0 and enter PID sleep mode.
➤	When PID output frequency is larger than the Wake threshold frequency for Wake start the inverter

will reactivate and enter PID wake mode. The time diagram is as follow:

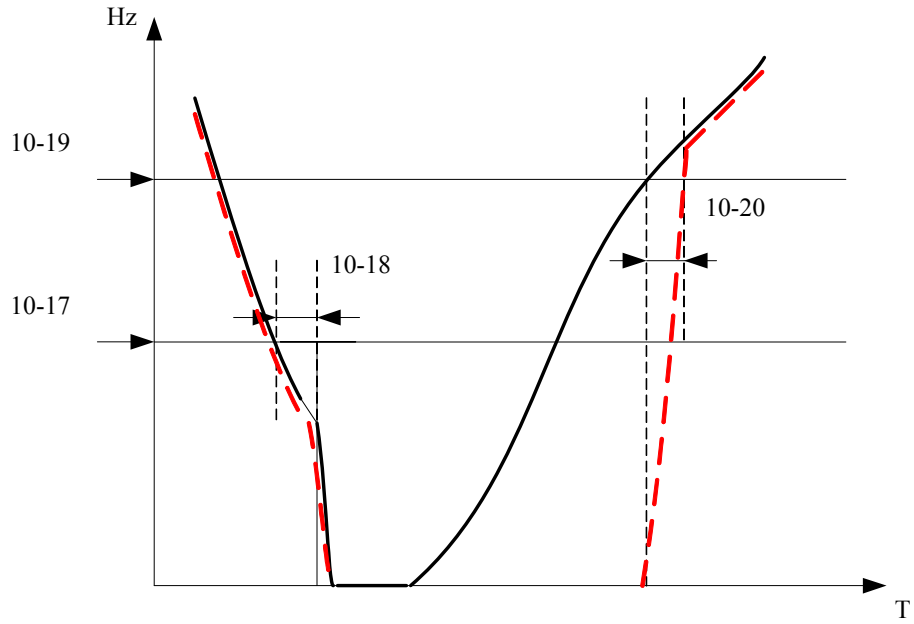

10-21	Max PID Feedback Setting
Range	【0 ~ 999】
10-22	Min PID Feedback Setting
Range	【0 ~ 999】

- Example: If set 10-21=100 and 10-22=50, When actual feedback value changes in a range of the smallest to the largest, feedback value read from keypad is limited between 50 and 100. Shown as below.

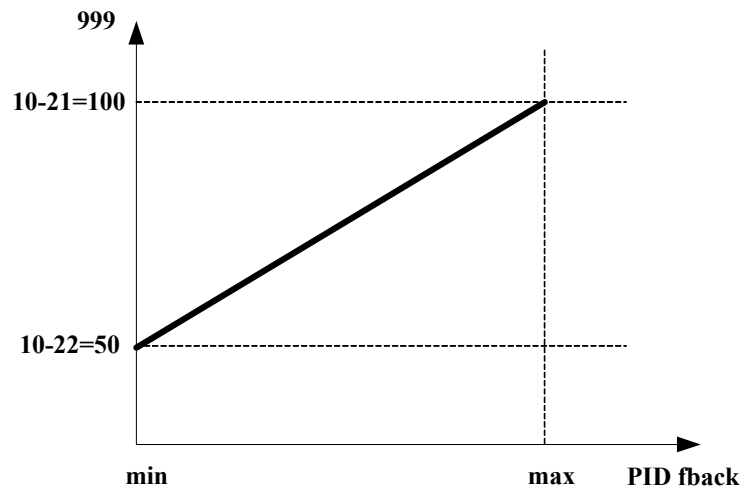

11 Assistant function group

11- 00	Prevention of Reverse operation
Range	【0】 :Reverse command is enabled 【1】 :Reverse command is disabled

➤ 11-00=1, the reverse command is **disabled**.

11- 01	Carrier Frequency
Range	【1~16】 KHz

11- 02	Carrier mode selection
Range	【0】 :Carrier mode0 3-phase PW M modulation 【1】 :Carrier mode1 2-phase PW M modulation 【2】 :Carrier mode2 2-phase randomized PW M modulation

11- 03	Carrier Frequency reduced by temperature raising
Range	【0】 :disable 【1】 :Enable

➤ When inverter is temperature overrun 80°C on keypad display(11-00=01000), Carrier Frequency reduced 4K.when inverter is temperature reduced less than 70°C, Carrier Frequency resume.

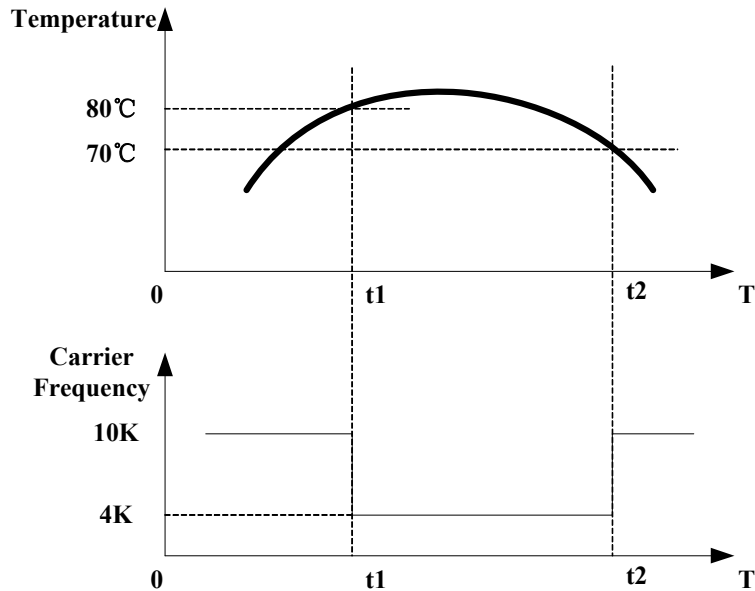

11- 04	S-Curve Acc 1
11- 05	S-Curve Acc 2
11- 06	S-Curve Dec 3
11- 07	S-Curve Dec 4
Range	【0.0 ~ 4.0】 Sec

➤ Use S Curve parameters where a smooth acceleration or deceleration action is required, this will prevent possible damage caused to machines by sudden acceleration/deceleration.

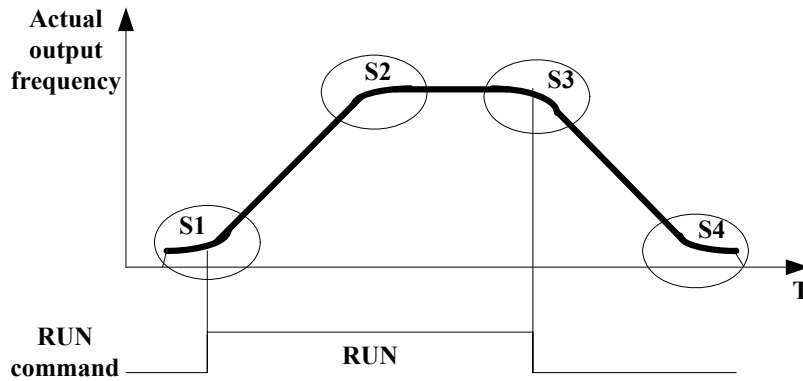

Note:

- Regardless of the stall prevention period, actual acceleration and deceleration time = preset acceleration / deceleration time + S curve time.
- Please set the S curve time separately in the parameter(11-04~11-07)
- When S curve time (11-04~11-07) is set as 0, the S curve function is disabled.
- The calculating of S curve time is based on the Maximum output frequency of motor (01-02), Please refer to the parameter (00-14/00-15).

11- 08	Skip frequency 1
11- 09	Skip frequency 2
11-10	Skip frequency 3
Range	【0.00 ~ 650.00】 Hz
11-11	Skip frequency range (±)
Range	【0.00 ~ 30.00】 Hz

Skip frequency parameters can be used to avoid mechanical resonance in certain applications.

Example: 11-08=10.00(Hz); 11-09=20.00(Hz); 11-10=30.00(Hz); 11-11=2.00(Hz).

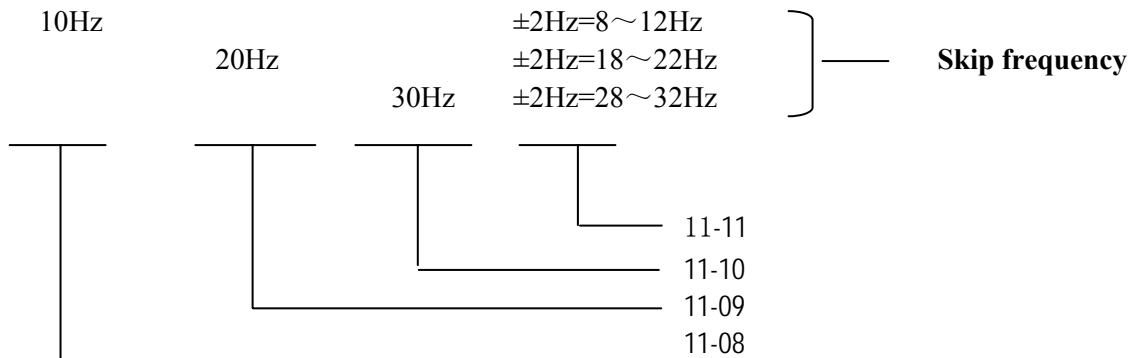

12 Monitor function group

12- 00	Display Mode
Range	0 0 0 0 0 high Low 00000~77777 Each of the range of 0 to 7 【0】 :Disable display 【1】 :output Current 【2】 :output Voltage 【3】 :DC voltage 【4】 :Temperature 【5】 :PID feedback 【6】 :AVI 【7】 :ACI

➤ Note: The highest bit of 12-00 sets the power on destined menu, other bits set user setting menus (prefer P4-4)

12- 01	PID Feedback Display Mode
Range	【0】 :Displayed in Integer (xxx) 【1】 :Displayed with One Decimal Place (xx.x) 【2】 :Displayed with Two Decimal Places (x.xx)
12- 02	PID Feedback Display Unit Setting
Range	【0】 :xxx-- 【1】 :xxxpb(pressure) 【2】 :xxxfl(flow)

12- 03	Custom Units (Line Speed) Display Mode
Range	【0~65535】 Rpm

➤ The max preset line value of 12-03 is equal to the Maximum output frequency of the motor. For instance, given line speed 1800 is equal to display 900 when output is 30Hz while the operation frequency is 60Hz.

12- 04	Custom Units (Line Speed) Display Mode
Range	【0】 :Drive Output Frequency is Displayed 【1】 :Line Speed is Displayed in Integer (xxxxx) 【2】 :Line Speed is Displayed with One Decimal Place (xxxx.x) 【3】 :Line Speed is Displayed with Two Decimal Places (xxx.xx) 【4】 :Line Speed is Displayed with Three Decimal Places (xx.xxx)

➤ 12- 04≠0, line speed is displayed while the inverter is running or stopped.

12- 05	Input and output terminal status display
Range	Read only(Panel read only)

➤ When any of S1 ~ S5 is turned on, corresponding tube in 12 - 05 lights, or all quench.
 ➤ When relays act, corresponding tubes light, or all quench.

Example 1: The following figure shows 12 - 05 display state when S1, S3, S5 turns ON and S2, S3 turns OFF and RY1 does not act.

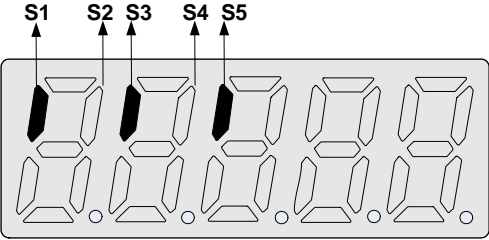

Example 2: The following figure shows 12 - 05 display state when S2, S3, S4 turns ON and S1, S5 turns OFF and RY1 acts.

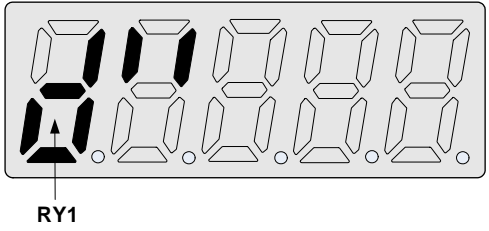

13 Maintenance function group

13- 00	Drive Horsepower Code
Range	----

Inverter Model:	13- 00 show	Inverter Model:	13- 00 show
L510-1P2-XXX	1102	L510-2P2-XXX	1202
L510-1P5-XXX	1105	L510-2P5-XXX	1205
L510-101-XXX	101	L510-201-XXX	201
		L510-202-XXX	202
		L510-203-XXX	203

13- 01	Software Version
Range	----

13- 02	Fault Log (Latest 3 times)
Range	----

- When the inverter trips on a fault, the previous fault log stored in 2.xxx will be transferred to 3.xxx, the one in 1.xxx to 2.xxx. The present fault will be stored in the empty register 1.xxx. The fault stored in 3.xxx is the last one of the most recent three, while the one 1.xxx is the latest.
- When pressing 'ENTER' at 13-02, the fault 1.xxx will be displayed first. Press ▲, to read 2.xxx→3.xxx→1.xxx press ▼ and the order is 3.xxx→2.xxx→1.xxx→3.xxx.
- When pressing 'Reset' at 13-02, the three fault log will be cleared when the reset key is pressed. The log content will change to 1. ---, 2. ---, 3. ---.
- E.g. the fault log content is '1.OC-C'; this indicates the latest fault is OC-C, etc.

13- 03	Accumulated Operation Time 1
Range	【0~23】 Hours
13- 04	Accumulated Operation Time 2
Range	【0~65535】 Days
13- 05	Accumulated Operation Time Mode
Range	【0】 :Power on time 【1】 :Operation time

- When the operation time is to 23 as the elapsed time 1 is set. The next hour will be carried to operation 13-04. Meanwhile, the recorded value will be cleared to 0000, and the record value of operation duration 2 will be 01.

13- 06	Parameter lock
Range	【0】 :Enable all Functions 【1】 :05- 01~05- 08 cannot be changed 【2】 :All Functions cannot be changed Except 05- 01~05- 08 【3】 :Disable All Function Except 13-06

- When the 13 - 07 = 00000 (not set a password) may be from the 13 - 06 set the parameters of 05 - 01 ~ 05 - 08 can be modified or can not be modified.

13- 07	Parameter password
Range	【00000~65535】

- When the 13-07 set the password is valid, all parameters can not be changed, only the lifting of a password to modify the parameters.

➤ Set Password:

Step1:

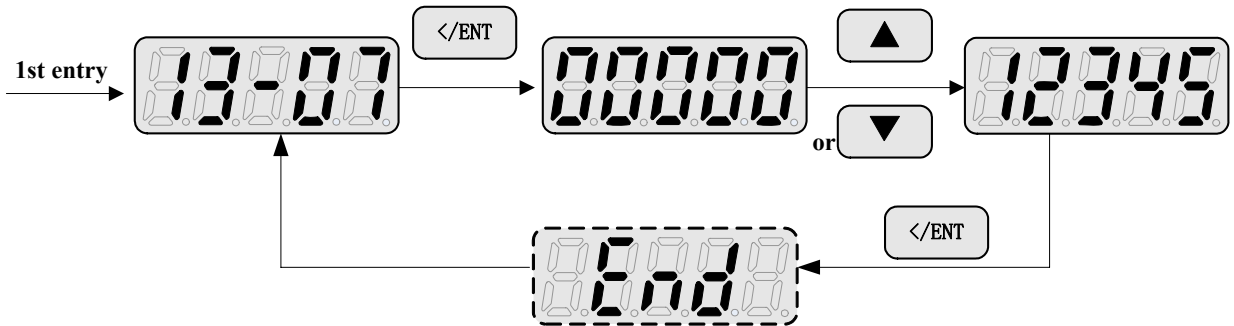

Step2:

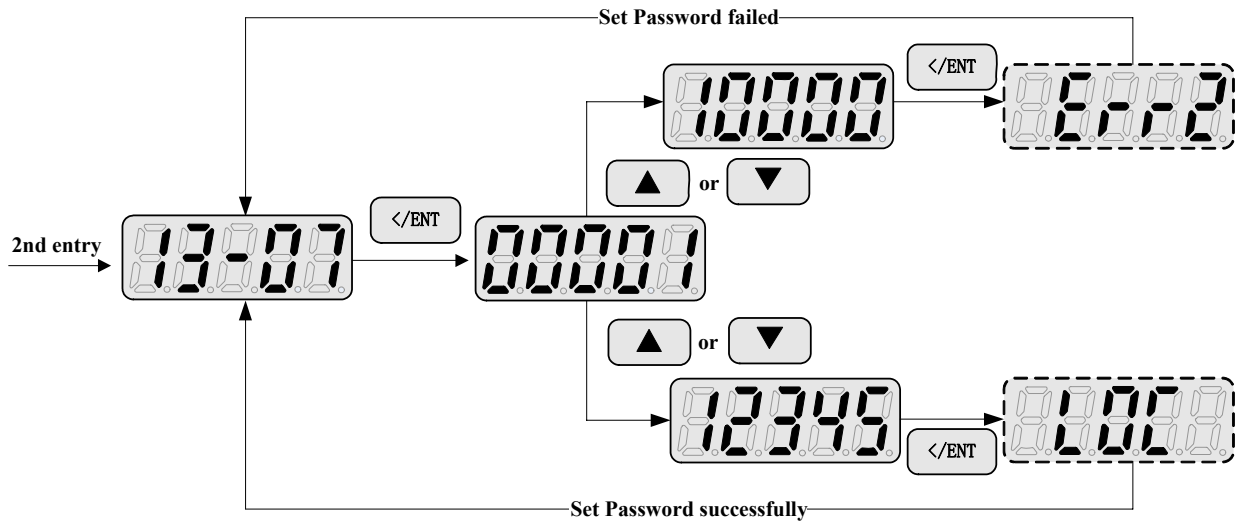

Lifting Password:

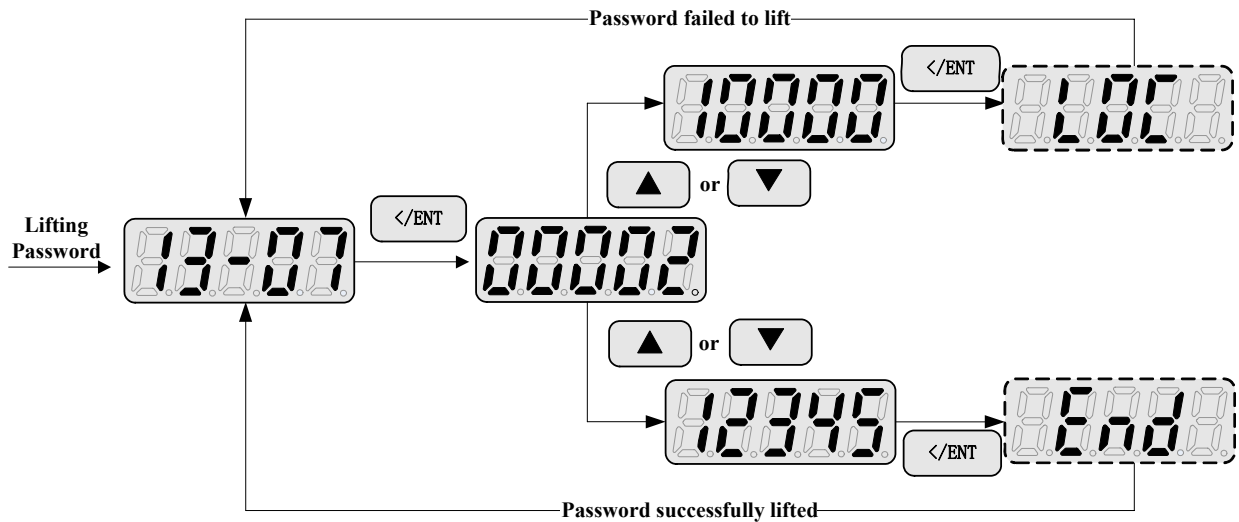

13- 08	Reset Drive to Factory Settings
Range	【1150】 :Reset to the 50Hz factory setting 【1160】 :Reset to the 60Hz factory setting

- When the parameter value is not set then for some reason, this parameter can be used to restore the default setting.
- When the 13 - 07 password set valid, must be lifted only after the password to restore factory settings.

Chapter 5 Troubleshooting and maintenance

5.1 Error display and corrective action

5.1.1 Manual Reset and Auto-Reset

Faults which can not be recovered manually			
Display	content	Cause	Corrective action
-oV- -oU-	Voltage too high when stopped	Detection circuit malfunction	Return the inverter
-LV- -LU-	Voltage too low when stopped	1. Power voltage too low 2. Pre-charge resistor or fuse burnt out. 3. Detection circuit malfunction	1. Check if the power voltage is correct 2. Replace the pre-charge resistor or the fuse 3. Return the inverter
-oH- -oH-	The inverter is overheated when stopped	1. Detection circuit malfunction 2. Ambient temperature too high or bad ventilation	1. Return the inverter 2. Improve ventilation conditions
CtEr [tEr	Current Sensor detection error	Current sensor error or circuit malfunction	Return the inverter
EPr EPr	EEPROM problem	Faulty EEPROM	Replace EEPROM
Cot [ot	Communication error	Communications disruption	Check the wiring
Faults which can be recovered manually and automatically			
Display	content	Cause	Corrective action
oC-A o[-A	Over-current at acceleration	1. Acceleration time too short 2. The capacity of the motor exceeds the capacity of the inverter 3. Short circuit between the motor coil and the case 4. Short circuit between motor wiring and ground 5. the IGBT module damaged	1. Set a longer acceleration time 2. Replace inverter with one that has the same rating as that of the motor 3. Check the motor 4. Check the wiring 5. Replace the IGBT module
oC-C o[-[-	Over-current at fixed speed	1. Transient load change 2. Transient power change	1. Increase the capacity of the inverter 2. Install inductor on the power Supply input side
oC-d o[-d	Over-current at deceleration	The preset deceleration time is too short.	Set a longer deceleration time
oC-S o[-S	Over current at start	1. Short circuit between the motor coil and the case 2. Short circuit between motor coil and ground 3. the IGBT module damaged	1. Inspect the motor 2. Inspect the wiring 3. Replace the transistor module
oV-C oU-[-	Excessive Voltage during operation/ deceleration	1. Deceleration time setting too short or excessive load inertia 2. Power voltage varies widely (fluctuates)	1. Set a longer deceleration time 2. Add a brake resistor or brake module 3. Add a reactor at the power input side

Faults which can be recovered manually but not automatically			
Display	content	Cause	Corrective action
oC oC	Over-current during stop	Detection circuit malfunction	Return the inverter for repair
oL1 oL1			
oL1 oL1	Motor overload	loading too large	Increase the Motor capacity
oL2 oL2	Inverter overload	Excessive Load	Increase the inverter capacity
LV-C LV-C			
LV-C LV-C	Voltage too low during operation	1.Power voltage too low 2.Power voltage varies widely (fluctuates)	1.Improve power quality 2.Add a reactor at the power input side

5.1.2 Keypad Operation Error Instruction

Display	content	Cause	Corrective action
LoC LoC	1. Parameter already locked 2.Motor direction locked 3. Parameter password(13 - 07) enabled	1. Attempt to modify frequency parameter while 13-06>0. 2.Attempt to reverse direction when 11- 00=1。 3. Parameter (13 - 07) enabled, set the correct password will show LOC.	1. Adjust 13-06 2.Adjust 11-00
Err1 Err1			
Err1 Err1	Keypad operation error	1.Press ▲ or ▼ while 00-05/00-06>0 or running at preset speed. 2.Attempt to modify the Parameter.Can not be modified during operation (refer to the parameter list).	1.The ▲ or ▼ is available for modifying the parameter only when 00-05/00-06=0 2. Modify the parameter in STOP mode.
Err2 Err2	Parameter setting error	1. 00-13 is within the range of (11-08 ± 11-11) or (11-09 ± 11-11) or (11-10 ± 11-11) 2.00- 12 ≧ 00-13	1.Modify 11-08~11-10 or 11-11 2.Set 00-12>00-13
Err5 Err5			
Err5 Err5	Modification of parameter is not available in communication	1.Control command sent during communication. 2.Attempt to modify the function 09-02 ~ 09-05 during communication	1.Issue enable command before communication 2. Set parameters 09-02 ~ 09-05 function before communication
Err6 Err6	Communication failed	1.Wiring error 2.Communication parameter setting error. 3.Incorrect communication protocol	1. Check hardware and wiring 2. Check Functions (09- 00~ 09- 05).
Err7 Err7			
Err7 Err7	Parameter conflict	1.Attempt to modify the function 13-00/13-08. 2.Voltage and current detection circuit is abnormal.	If Reset is not possible, please Return the inverter.

5.1.3 Special conditions

Display	Fault	Description
StP0 StP0	Zero speed at stop	Occurs when preset frequency <0.1Hz
StP1 StP1	Fail to start directly On power up.	If the inverter is set for external terminal control mode (00-02/00-03=1) and direct start is disabled (07-04=1) The inverter cannot be started and will flash STP1. The run input is active at power-up, refer to descriptions of (07-04).
StP2 StP2	Keypad Stop Operated when inverter in external Control mode.	If the Stop key is pressed while the inverter is set to external control mode (00-02/00-03=1) then 'STP2' flashes after stop. Release and re-activate the run contact to restart the inverter.
E.S. E.S.	External Rapid stop	The inverter will decelerate to stop and then flash E.S., when input external Rapid stop signal via the multifunctional input terminal activates
b.b. b.b.	External base block	The inverter stops immediately and then flashes b.b., when external base block is input by the multifunctional input terminals.
PdEr PdEr	PID feedback loss	PID feedback loss detect

5.2 General troubleshooting

Status	Checking point	Remedy
Motor runs in wrong direction	Are wiring for output terminals is correct?	Wiring must match U, V, and W terminals of the motor.
	Are wiring for forward and reverse signals correct?	Check for correct wiring.
The motor speed can not be regulated.	Is the wiring for the analog frequency inputs correct?	Check for correct wiring.
	Is the setting of operation mode correct?	Check the operation mode of the operator.
	Is the load too excessive?	Reduce the load.
Motor running speed too high or too low	Check the motor specifications (poles, voltage...) correct?	Confirm the motor specifications.
	Is the gear ratio correct?	Confirm the gear ratio.
	Is the setting of the highest output frequency correct?	Confirm the highest output frequency
Motor speed varies unusually	Is the load too excessive?	Reduce the load.
	Does the load vary excessively?	Minimize the variation of the load. Increase capacities of the inverter and the moto
	Is the input power erratic or is a phase loss occurring?	1. Add an AC reactor at the power input side if using single-phase power 2. Check wiring if using three-phase power
Motor can not run	Is power applied to L1, L2, and L3 terminals (is the charging indicator lit)?	1 Is the power applied 2. Turn the power OFF and then ON again. 3. Make sure the power voltage is correct 4. Make sure screws are secured firmly
	Is there voltage across the output terminals T1, T2, and T3?	Turn the power OFF and then ON again.
	Is overload causing the motor to stall?	Reduce the load so the motor will run.
	Are there any abnormalities in the inverter?	See error descriptions to check wiring and correct if necessary.
	Is forward or reverse run command issued?	
	Has the analog frequency signal been input?	1. Is analog frequency input signal wiring correct? 2. Is voltage of frequency input correct?
	Is the operation mode setting correct?	Operate through the digital keypad

5.3 Troubleshooting of INV

5.3.1 Quick troubleshooting of INV

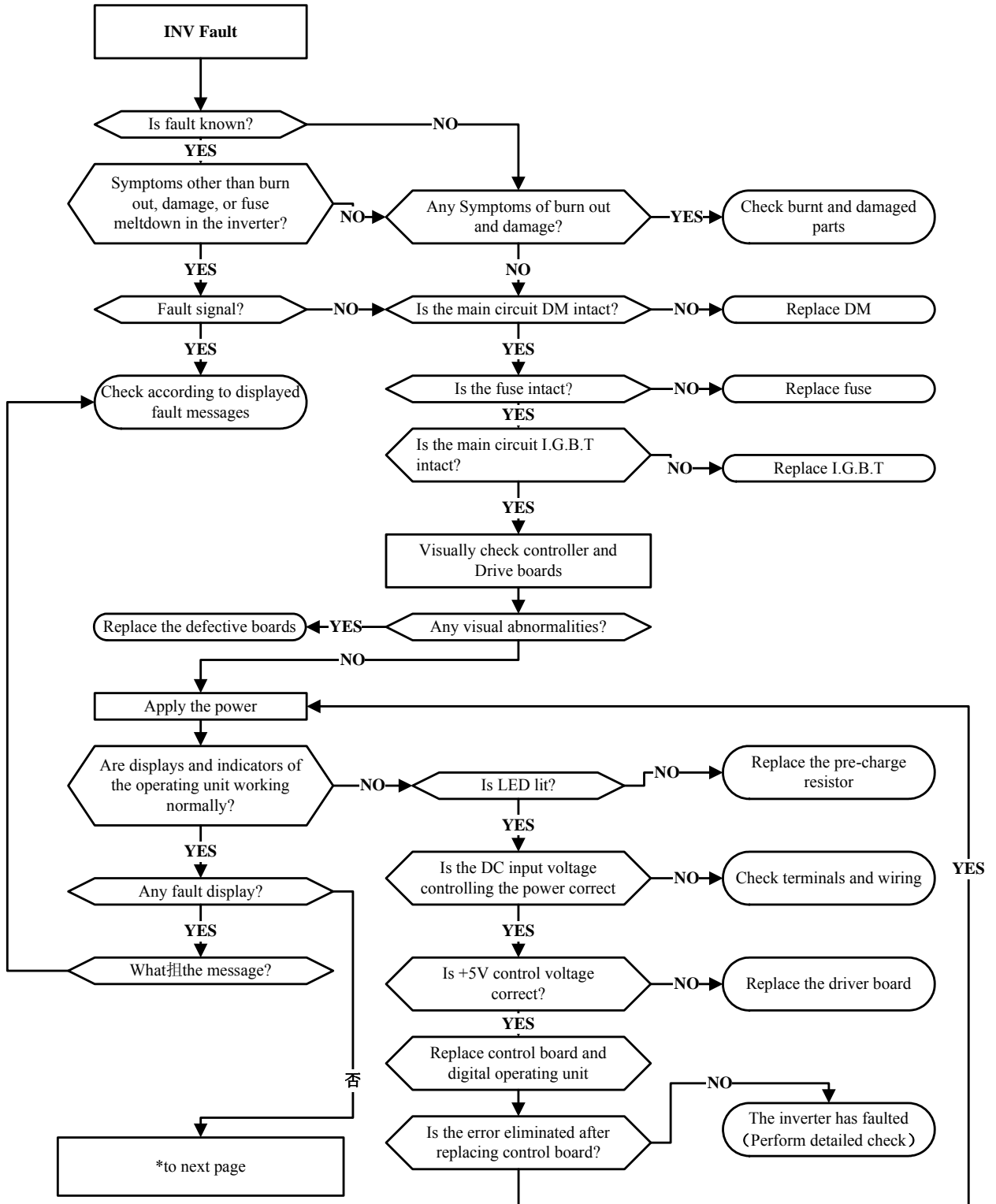

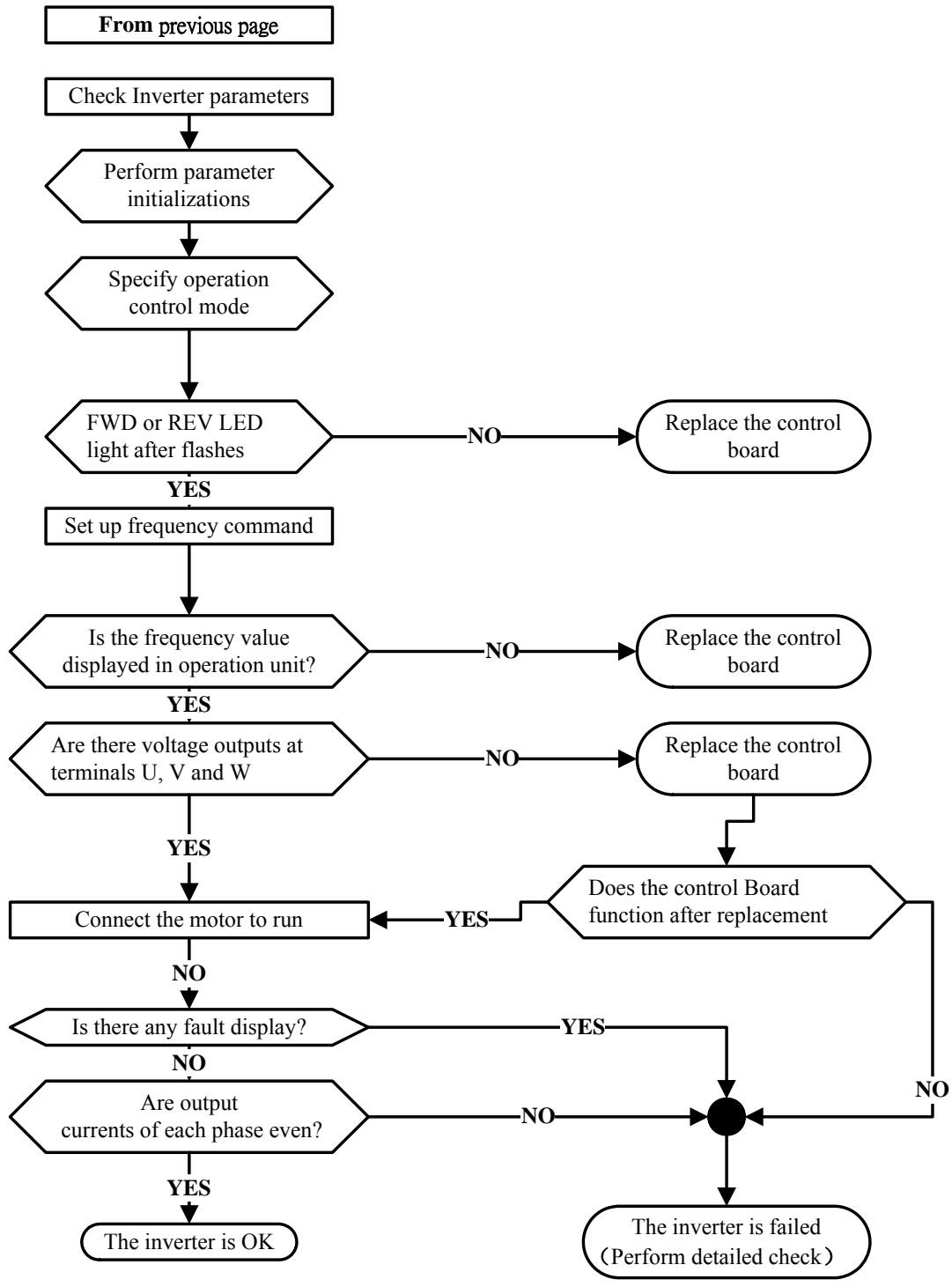

5.3.2 Troubleshooting for OC, OL error displays

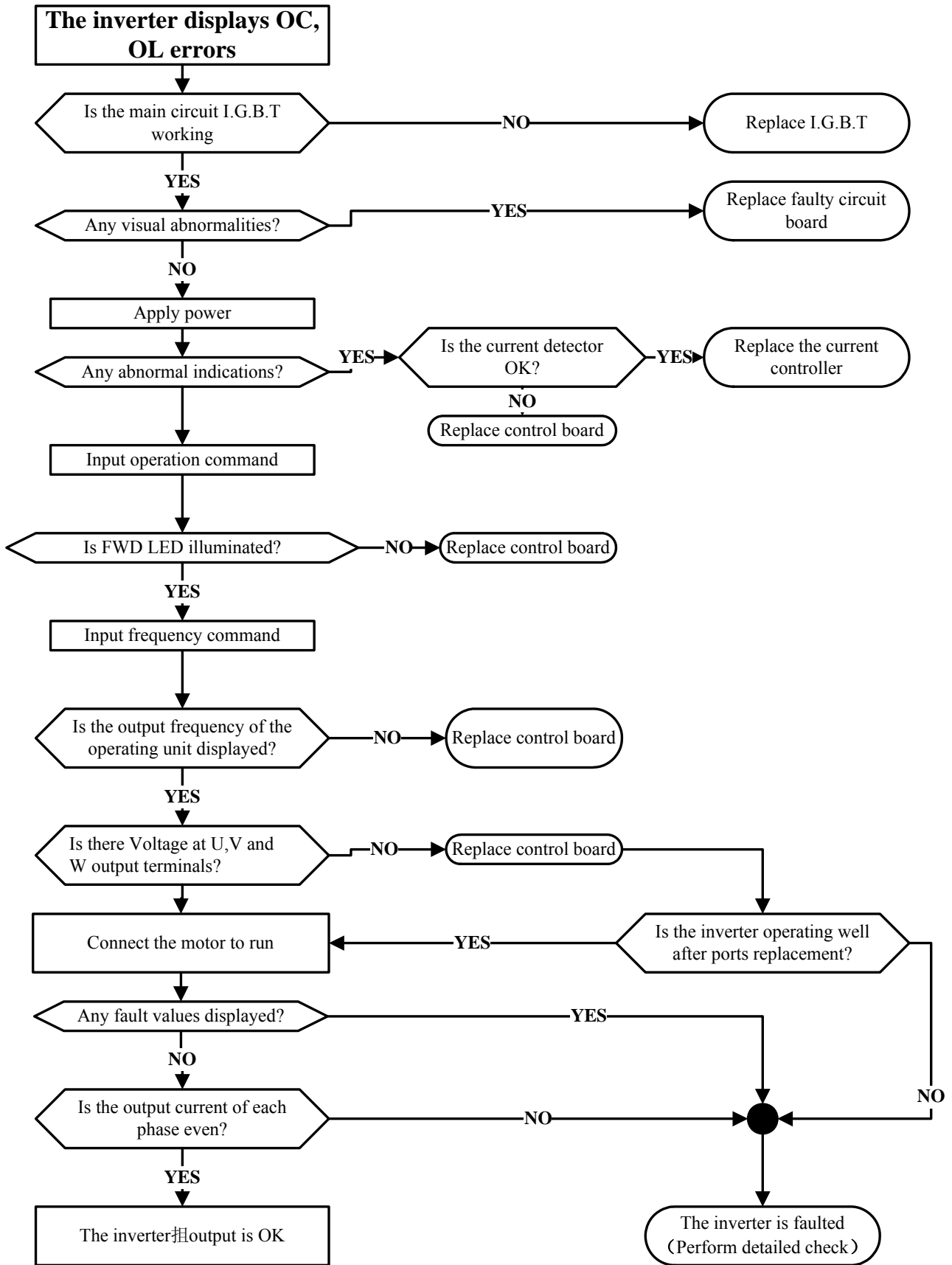

5.3.3 Troubleshooting for OV, LV error

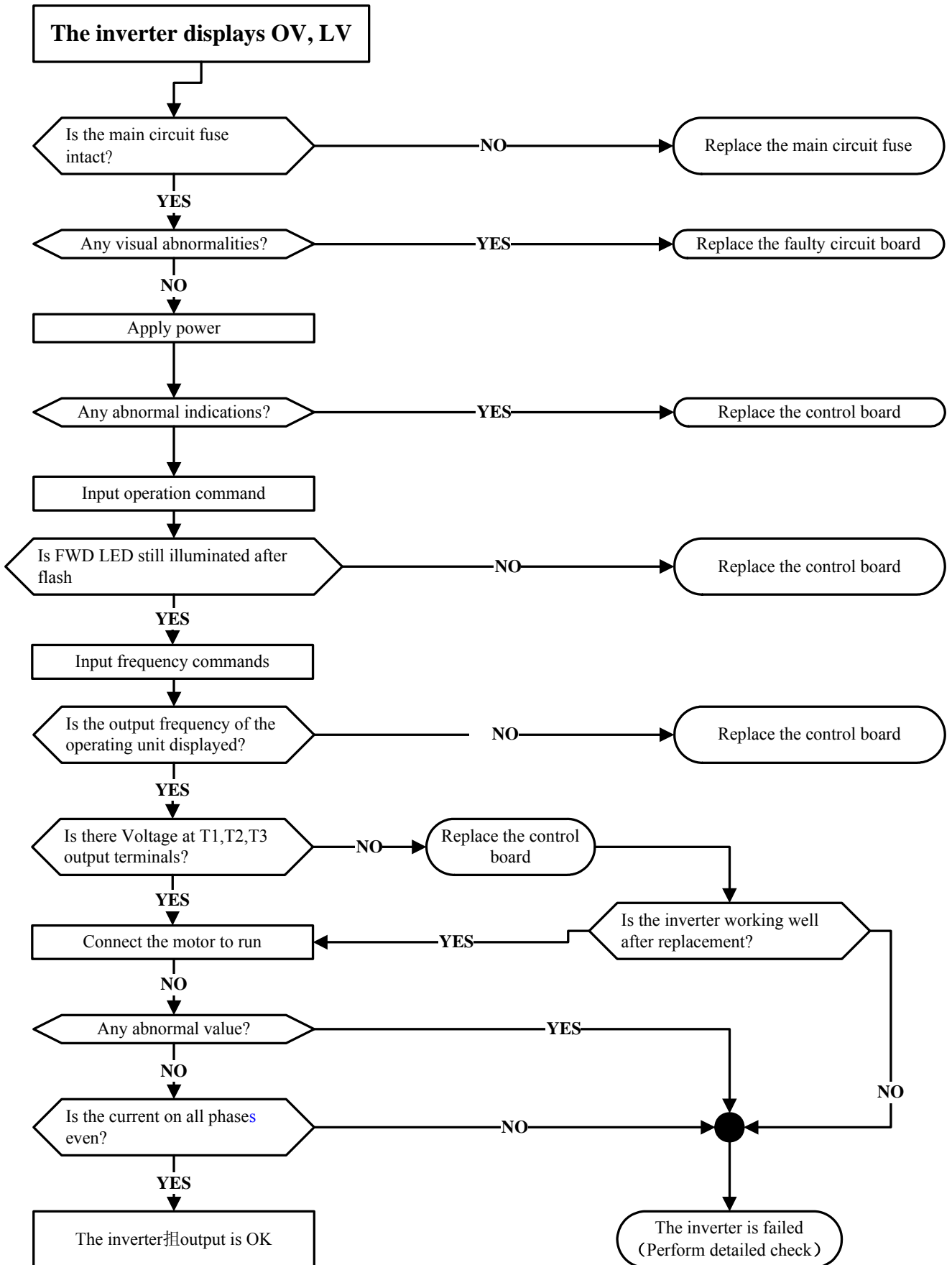

5.3.4 The motor can not run

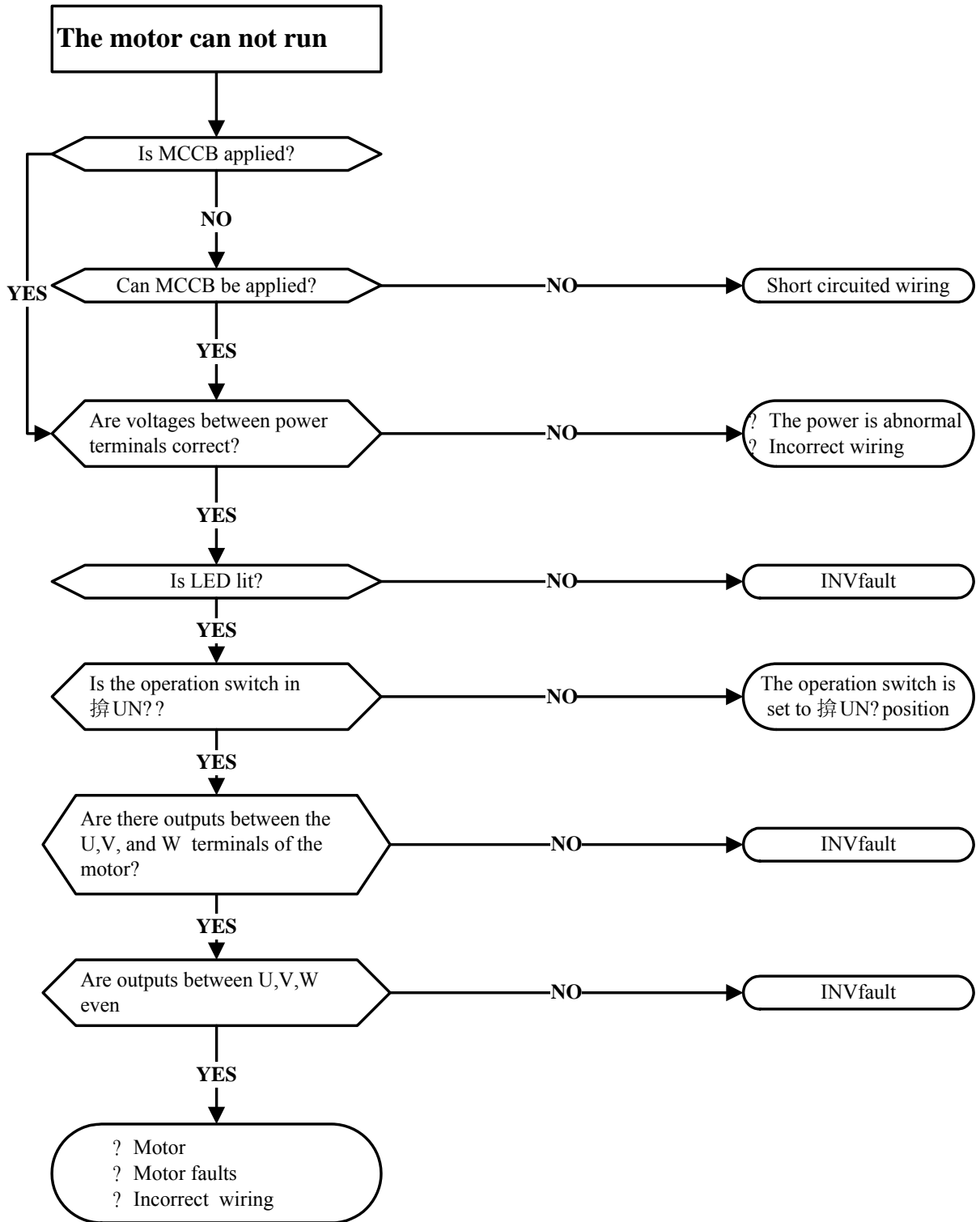

5.3.5 Motor Overheating

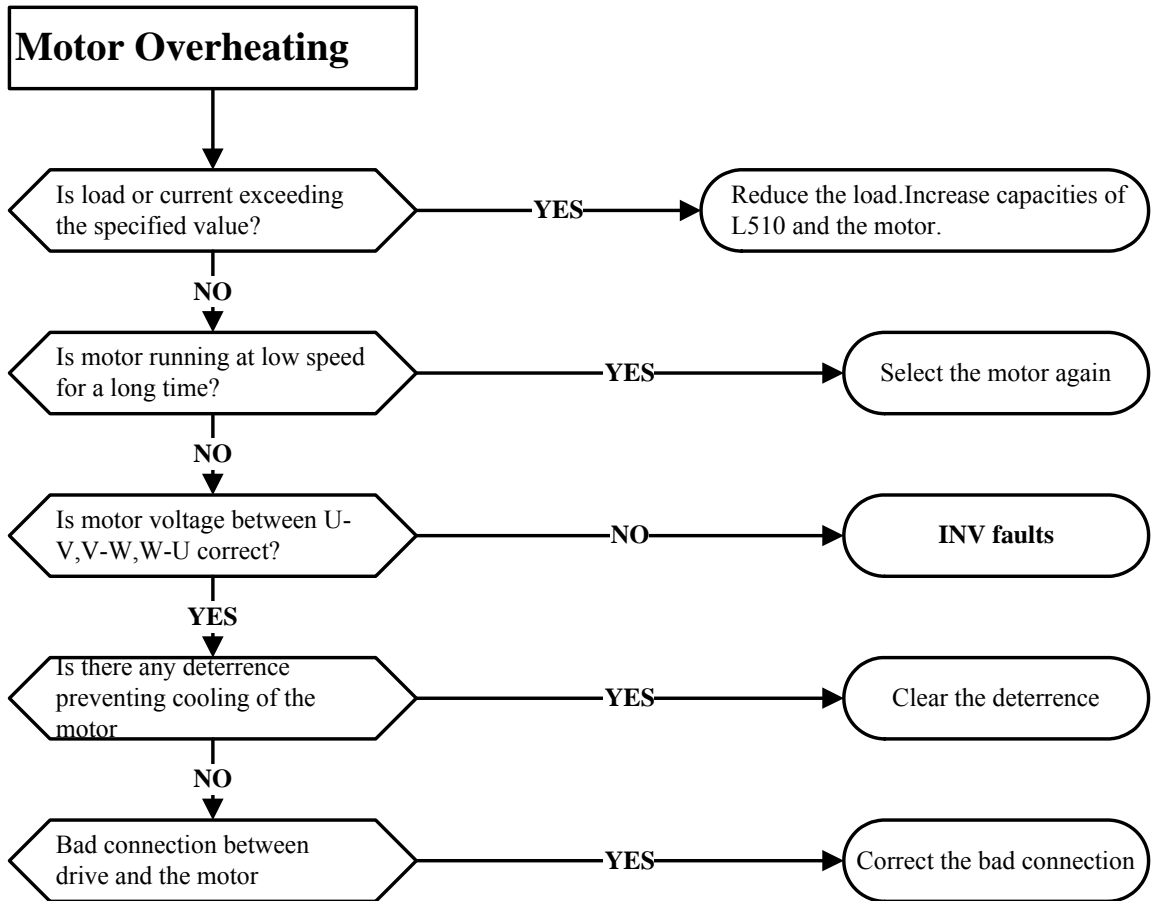

5.3.6 Motor runs unevenly

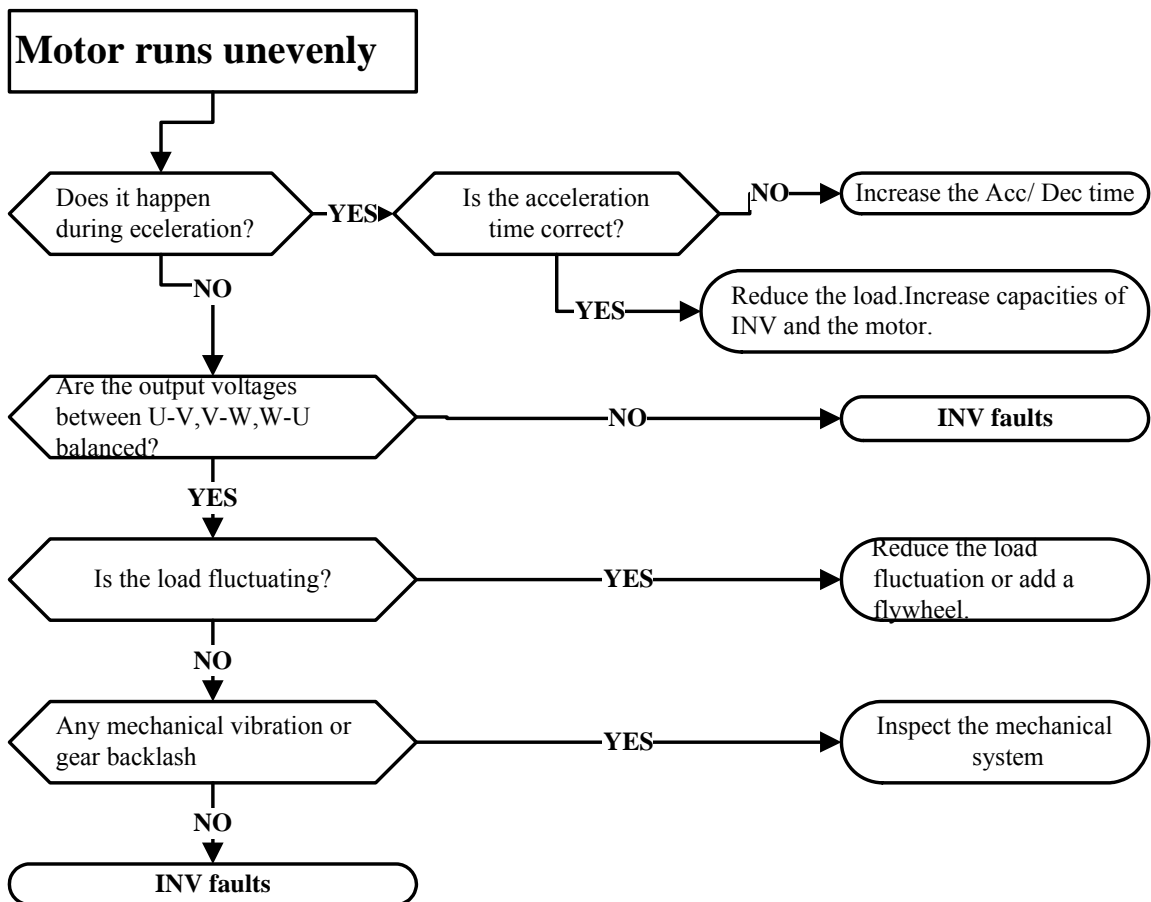

5.4 Routine and periodic inspection

To ensure stable and safe operations, check and maintain the inverter at regular intervals.

The table below lists the items to be checked to ensure stable and safe operations. Check these items 5 minutes after the “Charge” indicator goes out to prevent injury to personnel by residual electric power.

Items	Details	Checking period		Methods	Criteria	Remedies
		Daily	1Year			
Environment						
Ambient conditions around the machine	Confirm the temperature and humidity at the machine	○		Measure with thermometer and hygrometer	Temperature: -10 – 40oC (14-120°F) Humidity: Below 95%RH	Improve the ambient or relocate the drive to a better area.
	Are there inflammable materials in the vicinity?	○		Visual check	Keep area clear	
Installation and grounding of the inverter	Any unusual vibration from the machine	○		Visual, hearing check	Keep area clear	Secure screws
	Is the grounding resistance correct?		○	Measure the resistance with a multi-tester	200Vclass: below 100Ω	Improve the grounding
External terminals						
External terminals	Are secure parts loose?		○	Visual check	Secure terminals and no rust	Secure or send back for repair
	Is the terminal base damaged?		○	Check with a screwdriver		
	Visual rust stains present?		○			
internal mounting screws of the inverter	Any unusual bends or breaks?		○	Visual check	No abnormalities	Replace or send back for repair
	Any damage of the wire insulation?		○			
voltage						
Input power voltage	Is the voltage of the main circuit correct?	○		Measure the voltage with a multi-tester	Voltage must conform with the specifications	Improve input voltage
Circuit boards and components						
Printed circuit board	Excessive conductive metal shavings or oil sludge		○	Visual check	No abnormalities	Clean or replace the circuit board
	Discolored, overheated, or burned parts		○			
Capacitor	Any unusual odor or leakage	○		Visual check	No abnormalities	Replace capacitor or inverter
	Any deformity or protrusion	○				
Power component	Excessive dust or debris		○	Visual check	No abnormalities	Clean component
	Check resistance between each terminals		○	Measure with a multi-tester	No short circuit or broken circuit in three-phase output	Replace power component or inverter
Peripheral device						
Rheostat	Whether something smells stench or insulator breaks		○	Nose, Visual check	No abnormalities	Replacement rheostat
	Whether rheostat wiring or connector are damaged		○	Visual check	No abnormalities	
Electromagnetic Contactor	Whether contact with the connector is normal	○			No abnormalities	Replacement Contactor
	Unusual vibration and noise	○		hearing check	No abnormalities	
Reactor	Is there any unusual smell or sound	○		Nose, hearing check	No abnormalities	Replacement Reactor

Cooling System						
Cooling fan	Unusual vibration and noise		○	Visual or hearing check	No abnormalities	Replace the cooling fan
	Excessive dust or debris	○		Visual check	No abnormalities	Clean fan
Heat sink	Excessive dust or debris	○		Visual check	No abnormalities	Clean up debris or dust
Ventilation Road	Is the entrance or exit of the ventiduct choked by something	○		Visual check	No abnormalities	Clean

5.5 Maintenance

To ensure long-term reliability, follow the instructions below to perform regular inspection. Turn the power off and wait for the charge indicator (LED) to go out before inspection to avoid potential shock hazard from the charge stored in high-capacity capacitors.

1. Maintenance projects as follow

➤ Ensure that temperature and humidity around inverters is suitable, and there is good ventilation, also keeps away from heat sources
➤ Check the inside of the inverter, replace aged or damaged elements in time.
➤ Clean up the accumulation of any dust inside the inverter.
➤ Check the ground , ensure to connect properly.
➤ Terminal screws must be tight, especially the power input and output of the inverter.
(Do not perform this test against the control circuit.)

2. Method of Dielectric Withstand Voltage Test

Single Phase

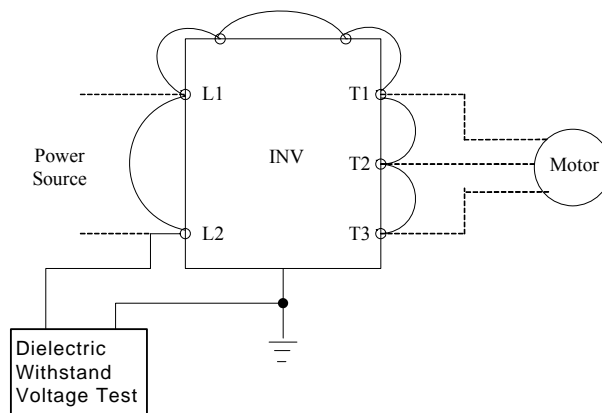

Three Phase

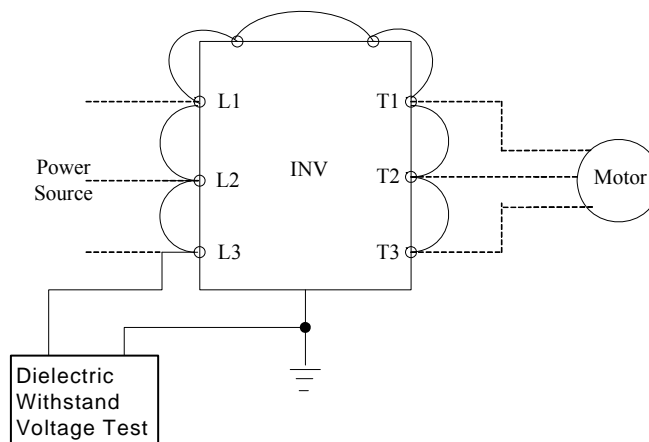

Chapter 6 Peripherals Components

6.1 Reactor Specifications

Model: L510-□□□-XXX-X	Specification	
	Current (A)	Inductance (mH)
2P2	3.0	7.0
2P5	5.2	4.2
201	9.4	2.1
202	19.0	1.1
203	25.0	0.71

6.2 Electromagnetic Contactor and No fuse circuit breaker

Model: L510-□□□-XXX-X	Molded-case circuit breaker made by TECO	Magnetic contactor (MC) made by TECO
1P2/1P5/2P2/2P5	TO-50E 15A	CN-11
101/201/202	TO-50E 20A	
203	TO-50E 30A	

6.3 Fuse Specification

Model: L510-□□□-XXX-X	Fuse types
1P2/1P5	10A, 300VAC
101	20A, 300VAC
2P2/2P5	10A, 300VAC
201	20A, 300VAC
202/203	30A, 300VAC

Appendix: L510 parameter setting list

Customer				Inverter Model			
Site Location				Contact Phone			
Address							
Parameter code	Setting content	Parameter code	Setting content	Parameter code	Setting content	Parameter code	Setting content
00-00		03-03		05-07		06-38	
00-01		03-04		05-08		06-39	
00-02		03-05		05-17		07-00	
00-03		03-06		05-18		07-01	
00-04		03-07		05-19		07-02	
00-05		03-08		05-20		07-03	
00-06		03-09		05-21		07-04	
00-07		03-10		05-22		07-05	
00-08		03-11		05-23		07-06	
00-09		03-12		05-24		07-07	
00-10		03-13		05-25		07-08	
00-11		03-14		05-26		08-00	
00-12		03-15		05-27		08-01	
00-13		03-16		05-28		08-02	
00-14		03-17		05-29		08-03	
00-15		03-18		05-30		08-04	
00-16		03-19		05-31		08-05	
00-17		04-00		05-32		08-06	
00-18		04-01		06-00		08-07	
00-19		04-02		06-01		08-08	
00-20		04-03		06-02		08-09	
01-00		04-04		06-03		09-00	
01-01		04-05		06-04		09-01	
01-02		04-06		06-05		09-02	
01-03		04-07		06-06		09-03	
01-04		04-08		06-07		09-04	
01-05		04-09		06-16		09-05	
01-06		04-10		06-17		09-06	
01-07		04-11		06-18		09-07	
01-08		04-12		06-19		09-08	
01-09		04-13		06-20		09-09	
01-10		04-14		06-21		10-00	
01-11		04-15		06-22		10-01	
02-00		05-00		06-23		10-02	
02-01		05-01		06-32		10-03	
02-02		05-02		06-33		10-04	
02-03		05-03		06-34		10-05	
03-00		05-04		06-35		10-06	
03-01		05-05		06-36		10-07	
03-02		05-06		06-37		10-08	

Parameter code	Setting content	Parameter code	Setting content	Parameter code	Setting content	Parameter code	Setting content
10-09		10-21		11-10		13-04	
10-10		10-22		11-11		13-05	
10-11		11-00		12-00		13-06	
10-12		11-01		12-01		13-07	
10-13		11-02		12-02		13-08	
10-14		11-03		12-03			
10-15		11-04		12-04			
10-16		11-05		12-05			
10-17		11-06		13-00			
10-18		11-07		13-01			
10-19		11-08		13-02			
10-20		11-09		13-03			