



**Microprocessor Controlled
I G B T Drive
Inverter Motor Speed Regulator
Operating Manual**

E310 Series	200V class	0.4~1.5KW (1.2~2.9KVA)
	400V class	0.75~3.7KW (1.7~6.7KVA)



Chapter 0	Preface	0-1
0.1	Preface	0-1
0.2	Product Inspection	0-1
Chapter 1	Safety Precautions	1-1
1.1	Operation Precautions	1-1
	1.1.1 Before Power UP	1-1
	1.1.2 During Power UP	1-2
	1.1.3 Before Operation	1-2
	1.1.4 During Operation	1-3
	1.1.5 During Maintenance	1-3
Chapter 2	Definition of Model	2-1
Chapter 3	Ambient Environment and Installation	3-1
3.1	Environment	3-1
3.2	Environmental Precautions	3-2
3.3	Electrical Installation	3-3
	3.3.1 Wiring guidelines	3-3
	3.3.2 Contactor and Circuit Breaker specification and wiring	3-4
	3.3.3 Precautions for Peripheral Applications	3-5
3.4	Specifications	3-8
	3.4.1 Product Specifications	3-8
	3.4.2 General Specifications	3-9
3.5	Wiring Diagram E310 Series Inverter	3-11
3.6	Description of connection terminals	3-12
3.7	Outline Dimension	3-13
Chapter 4	Software Index	4-1
4.1	Keypad Description	4-1
	4.1.1 Keypad Display and Operation Instruction	4-1
	4.1.2 Operation Instruction of the LED keypad	4-2
4.2	Control Mode Selection	4-3
4.3	E310 Programmable Functions List	4-4
4.4	Parameter Function Description	4-18
Chapter 5	Troubleshooting and Maintenance	5-1
5.1	Error Display and Corrective Action	5-1
	5.1.1 Faults which can not be recovered manually	5-1
	5.1.2 Special conditions	5-2
	5.1.3 Operation errors	5-3
5.2	General Troubleshooting	5-4
5.3	Quick Troubleshooting of E310	5-5
5.4	Routine and periodic inspection	5-11
5.5	Maintenance and Inspection	5-12
Chapter 6	Peripheral Components	6-1
6.1	Reactor Specification at Input Side	6-1
6.2	Braking unit and braking Resistor	6-1
6.3	Digital operator and extension cable	6-2
Appendix I	E310 Parameters Setting List	App1

Index of Figures

Figure 2-1 Inverter Nameplate	2-1
Figure 3-1 Panel and enclosure arrangement for E310 inverters	3-1
Figure 3-2 Din rail mounting of the E310 inverter	3-1
Figure 3-3 Typical Installation Schematic.....	3-5
Figure 3-4a) Installation Examples.....	3-6
b) Installation Examples Using a Filter and Isolation transformer	3-6
c) Installation Examples with Adjacent Signal Conductors	3-6
Figure 3-5 Control Cable requirements	3-7
Figure 3-6 Grounding Examples	3-7
Figure 3-7 Wiring Diagram.....	3-11
Figure 3-8 Frame size 1 Dimensions	3-13
Figure 3-9 Frame size 2 Dimensions	3-14
Figure 4-1 Keypad Layout	4-1
Figure 4-2 LED Keypad Operations Sequence.....	4-2
Figure 4-3 Control Mode Selection Chart.....	4-3
Figure 4-4 Frequency reference limits	4-18
Figure 4-5 Terminal Board Drive Operation Modes	4-19
Figure 4-6 3-Wires Start/Stop Wiring.....	4-19
Figure 4-7 Drive Start/Stop Operation sequences	4-20
Figure 4-8 Acceleration and deceleration Prohibit	4-22
Figure 4-9 UP/DOWN original mode example	4-24
Figure 4-10 UP/DOWN with incremental steps.....	4-24
Figure 4-11 Frequency reached example	4-25
Figure 4-12 Frequency within specified range example.....	4-26
Figure 4-13 Frequency outside of range example	4-26
Figure 4-14 Frequency at or below specified range example.....	4-27
Figure 4-15 Over torque detection example	4-27
Figure 4-16 Analog scaling examples	4-29
Figure 4-17 Multifunction analog output.....	4-29
Figure 4-18 KEB function diagram	4-34
Figure 4-19 DC Injection Braking Example.....	4-34
Figure 4-20 Custom V/F settings	4-35
Figure 4-21 Custom V/F Patterns.....	4-36
Figure 4-22 V/F curve with torque boost	4-37
Figure 4-23 Output Torque Capacity	4-38
Figure 4-24 Slip Compensation	4-39
Figure 4-25 Low Frequency Voltage Compensation.....	4-39

Figure 4-26 PID block diagram	4-43
Figure 4-27 PID sleep wake mode diagram.....	4-45
Figure 4-28 S-Curve Characteristics	4-47
Figure 4-29 Single cycle auto run	4-51
Figure 4-30 Periodic cycle auto run.....	4-52
Figure 4-31 Single cycle auto run: final step hold.....	4-52
Figure 4-32 AUTO_RUN cycle with interrupt	4-53
Figure 5-1 E310 Fault Display and Troubleshooting Flow Chart.....	5-6
Figure 5-2 OC, OL Fault Display Flow Chart.....	5-7
Figure 5-3 OV, LV Fault Display Flow Chart	5-8
Figure 5-4 Motor RUN failure Flow chart	5-9
Figure 5-5 Motor Overheat Troubleshooting Flow Chart.....	5-10
Figure 5-6 Motor Instability Troubleshooting Flow Chart	5-10
Figure 6-1 Digital Operator Extension Cable.....	6-2

Chapter 0 Preface

0.1 Preface

To extend the performance of the product and ensure personnel safety, please read this manual thoroughly before using the inverter. Should there be any problem in using the product that cannot be solved with the information provided in the manual, contact your nearest Taian's technical or sales representative who will be willing to help you.

※Precautions

The inverter is an electrical product. For your safety, there are symbols such as “Danger”, “Caution” in this manual as a reminder to pay attention to safety instructions on handling, installing, operating, and checking the inverter. Be sure to follow the instructions for highest safety.

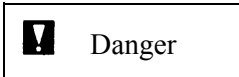

Indicates a potential hazard that could cause death or serious personal injury if misused.

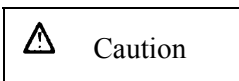

Indicates that the inverter or the mechanical system might be damaged if misused.

Danger

- Do not touch any circuit boards or components after the power is turned off and while the charging indicator is still lit. (The light will fade)
- Do not make any connections when the inverter is powered on. Do not check parts and signals on circuit boards during the inverter operation.
- Do not disassemble the inverter or modify any internal wires, circuits, or parts.
- Ground the ground terminal of the inverter properly.
For 200V class ground resistance 100 Ω or below. For 400V class 10Ω or below.
Make sure that grounding conductors are adequately sized and are according to your local safety regulations.

Caution

- Do not perform a voltage test on parts inside the inverter. High voltage can destroy the semiconductor components.
- Do not connect T1, T2, and T3 terminals of the inverter to any AC input power supply.
- CMOS ICs on the inverter's main board are susceptible to static electricity. Do not touch the main circuit board

0.2 Product Inspection

Taian inverters have all passed the function test before delivery. Please check the following when you receive and unpack the inverter:

- The model of the inverter are the same as those specified in your purchase order.
- Check for any damages caused by transportation. Please do not apply power, and contact a Taian sales representative if any of the above problems occurred.

Chapter 1 Safety Precautions

1.1 Operation Precautions

1.1.1. Before Power Up

Caution

The line voltage applied must comply with the inverter's specified input voltage.(See product nameplate)

Danger

Make sure the main circuit connections are correct. L1, L2 and L3 are power-input terminals and must not be mistaken for T1, T2 and T3. Otherwise, inverter damage can result.

Caution

- To avoid the front cover from disengaging or other damage, do not carry the inverter by its cover. Support the drive by its heat sink when transporting. Improper handling can damage the inverter or injure personnel, and should be avoided.
- To avoid the risk of fire, do not install the inverter on flammable objects. Install on nonflammable objects such as metal surfaces.
- If several inverters are placed in the same control panel, provide heat extraction means to keep the temperature below 40°C to avoid overheat or fire hazard.
- When removing or installing the operator keypad, turn OFF the power first, and secure the keypad correctly to avoid keypad operation or display failure.

Warning

This product is sold subject to IEC 61800-3. In a domestic environment this product may cause radio interference in which case the user may be required to apply corrective measures.

1.1.2. During Power Up

Danger

- Do not insert or remove input connections to the inverter when powered up to avoid damage to the control board resulting from possible voltage surge due to contact bounce.
 - When momentary power loss is longer than 2 seconds (the larger of horse power, the longer of time), the inverter does not have enough storage power to control the circuit; Therefore, when the power is re-applied, the operation of the inverter is based on the setup of 00-03(or00-04) /04-09 and the condition of external switch, this is considered to be 「restart」 in the following paragraphs.
 - When the momentary power loss is short, the inverter still has enough storage power to control the circuit. Therefore, when power is re-applied, the inverter will automatically restart depending on the setup of 04-03/04-04.
 - When **restarting** the inverter, the operation of the inverter is based on the setup of 00-03(or00-04) and 04-09 and the condition of external switch (FWD/REV button). Attention: the start operation will be regardless of 04-03/04-04/04-06/04-07.
 1. When 00-03(or00-04) =0, the inverter will not automatically run after restart.
 2. When 00-03(or00-04) =1 and the external switch is OFF, the inverter will not run after restart.
 3. When 00-03(or00-04) =1, the external switch is ON, and 04-09=0, the inverter will run automatically after restart.
- Attention:** To ensure safety, please turn off the external switch (FWD/REV button) after power loss, to protect machines from possible damage and potential injury to personnel on sudden resumption of power.
- If 4-09 is set to 0 (direct start up), please refer to the description and warnings for 04-09 to verify the safety of operator and machine.

1.1.3. Before Operation

Danger

Make sure the model and inverter capacity are the same as that set in parameter 12-00.

Caution

On power up the supply voltage set in parameter 05-03 will flash on display for 2 seconds.

1.1.4. During Operation

Danger

Do not connect or disconnect the motor during operation. Otherwise, the over-current will cause the inverter to trip or damage the unit.

Danger

- To avoid electric shock, do not take the front cover off when power is on.
- The motor will restart automatically after stop when auto-restart function is on. In this case, use caution while working near the drive, motor, or driven equipment.
- Note: The stop push button and external stop command have no safety function.

For Emergency stop, it is necessary to use a correct latch type push button and an appropriate circuit or devices to ensure safety.

Caution

- Do not touch heat-generating components such as heat sinks and braking resistors.
- The inverter can drive the motor from low speed to high speed. Verify the allowable speed range of the motor and the load before operation.
- Note the settings related to the braking unit.
- Do not check signals on circuit boards while the inverter is running.

Caution

Allow 5 minutes after disconnecting power before disassembling or checking the components. The power led should not be illuminated.

1.1.5. During Maintenance

Caution

The Inverter can be used in a non-condensing environment in temperature range from 14°-104°F (-10-40°C) and relative humidity of 95%

Inverter Disposal

Caution

- Please dispose of this unit with care as an industrial waste and according to your required local regulations.
- The capacitors of inverter main circuit and printed circuit board are considered as hazardous waste and must not be burnt.
- The Plastic enclosure and parts of the inverter such as the top cover board will release harmful gases if burnt.

Chapter 2 Definition of model

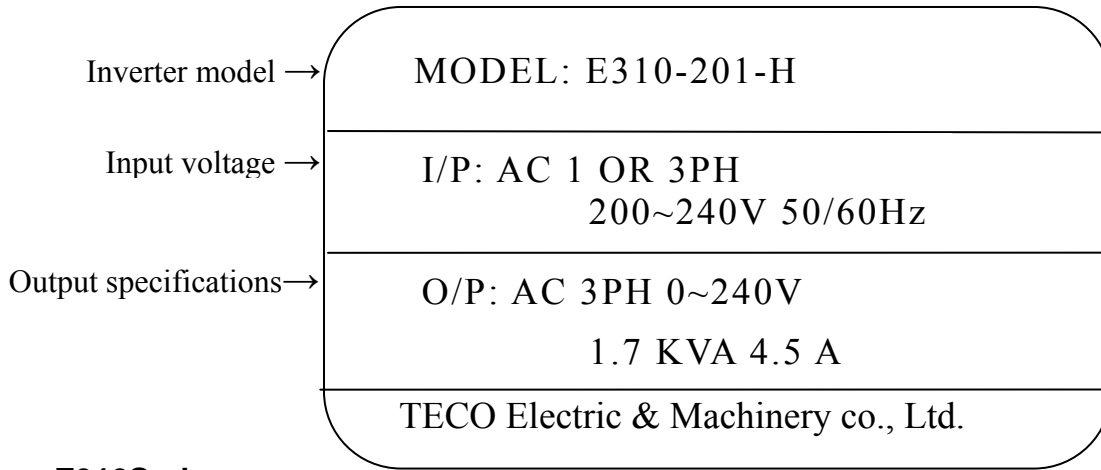

E310Series:

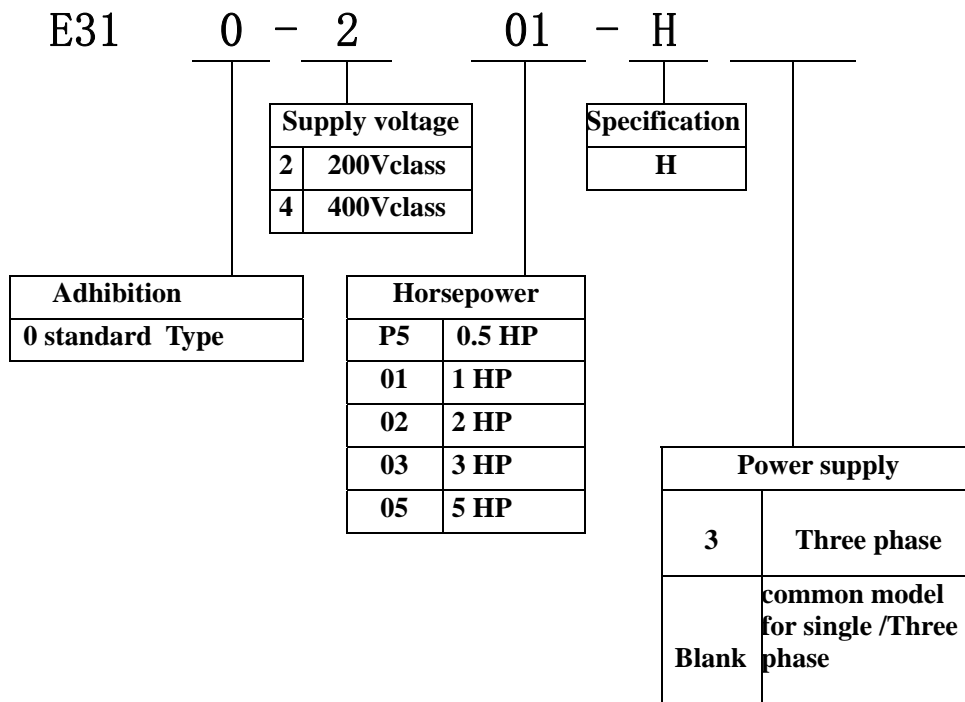

Figure 2-1 Inverter Nameplate

Chapter 3 Ambient Environment and Installation

3.1 Environment

The environment will directly affect the proper operation and the life span of the inverter, so install the inverter in an environment complying with the following conditions:

- Ambient temperature: 14-104°F(-10°C - +40°C)
- Avoid exposure to rain or moisture.
- Avoid oil mist and salinity.
- Avoid dust, lint fibers, and small metal filings.
- Avoid electromagnetic interference (soldering machine, power machine).
- Avoid vibration (stamping, punching machine). Add a vibration-proof pad if the situation cannot be avoided.
- If several inverters are placed in the same control panel, provide heat removal means to maintain temperatures below 40°C.
- Avoid direct sunlight.
- Avoid corrosive liquid and gas.
- Keep away from radioactive and flammable materials.

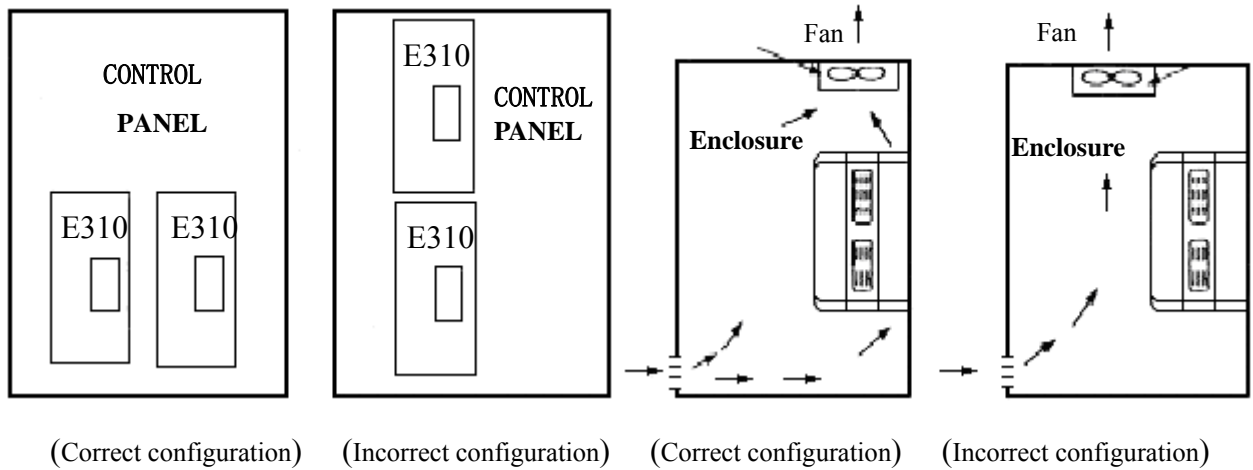

Figure 3-1 Panel and enclosure arrangement for E310 inverters

- Place the inverter facing forward and its top facing upward to assist with cooling.

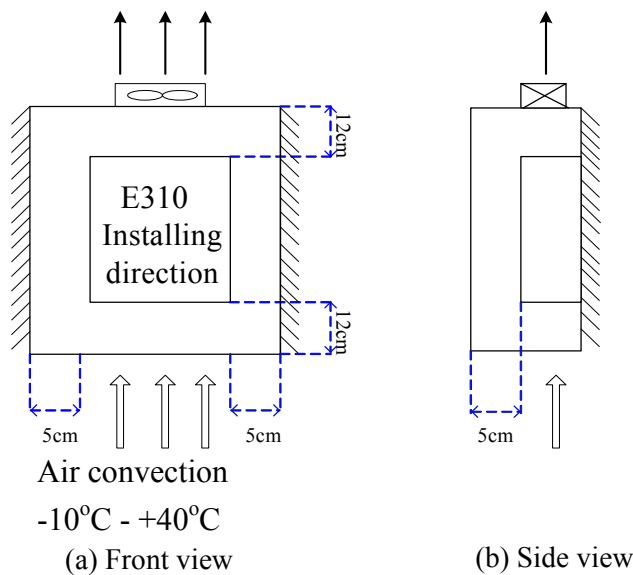
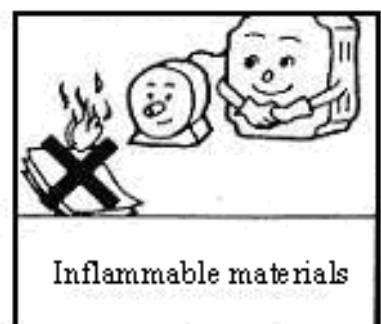
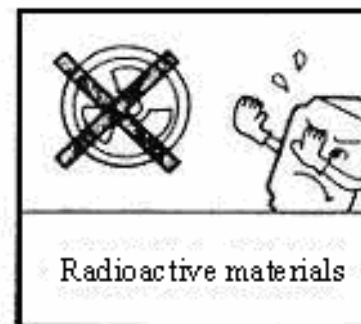
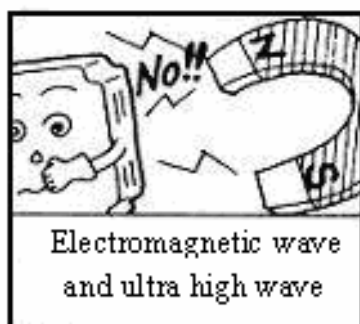
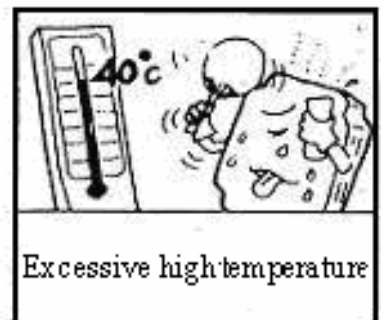
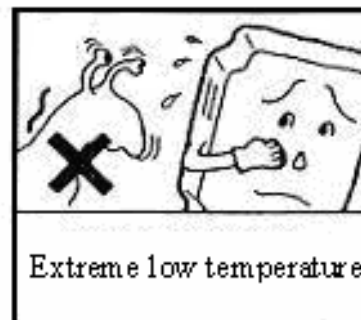
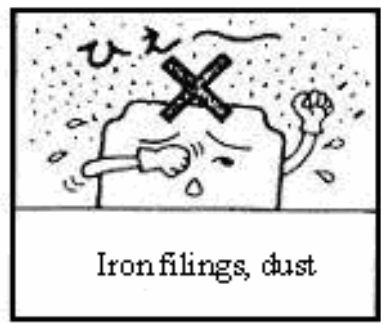
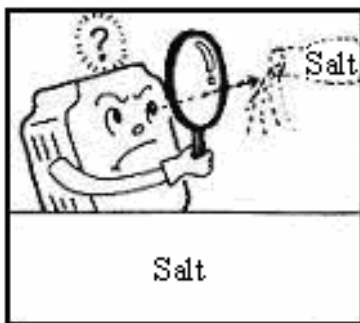
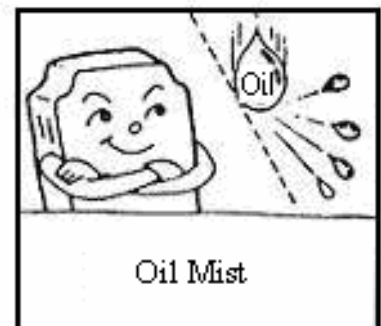
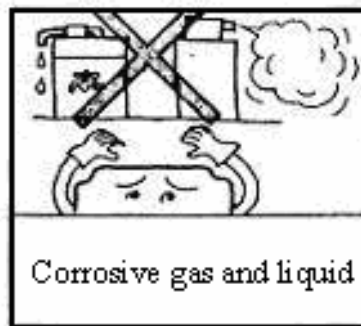
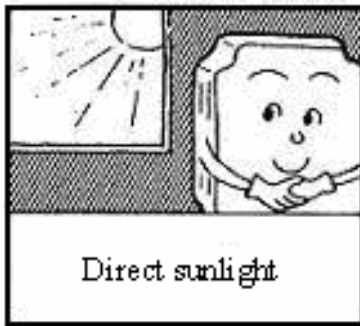

Figure 3-2 Din rail mounting of the E310 Inverter

3.2 Environmental precautions

Do not use the inverter in an environment with the following conditions:



3.3 Electrical Installation

3.3.1 Wiring guidelines

A. Power Cables

Power cables are connected to TM1 terminal block, terminals L1, L2, L3, T1, T2, T3, P, R. Choose power cables according to the following criteria:

- (1) Use copper wires only. Correct wire diameters should be based on ratings at 105°C.
- (2) For rating voltage of wires, the minimum voltage of 200V class type is 300V, and 400 V class type is 600V.

B. Control Cables

Control cables are connected to TM2 control terminal block.

Choose control cables according to the following criteria:

- (1) Use copper wires only. Correct wire diameters should be based on ratings at 105°C.
- (2) For rating voltage of wires, the minimum voltage of 200V class type is 300V, and 400 V class type is 600V.
- (3) To avoid noise interference, do not route power and control cables in the same conduit or trucking.
- (4) Where possible use screened / shielded control cables to minimize electromagnetic interference.
- (5) To avoid ground loops always earth the shield of control cables at one end only.

C. Nominal electrical specifications of the terminal Block TM1:

Horsepower	Power source	Amps	Volts
0.5/1/ 2	200-240V	15	600
1/ 2	380-480V		
3/ 5	380-480V	40	

※Note: Nominal values of input and output signals (TM2 , TM3) – follow the specifications of class 2 wiring.

D. Fuse types

Drive input fuses are provided to disconnect the drive from power in the event that a component fails in the drive's power circuitry. The drive's electronic protection circuitry is designed to clear drive output short circuits and ground faults without blowing the drive input fuses. Table below shows the E310 input fuse ratings.

To protect the inverter most effectively, use fuses with current-limit function.

Horsepower	power supply standard	Fuse types
1/2	200-240V	15A, 600VAC, 100KA I.R.
1	380-480V	5A, 600VAC, 100KA I.R.
2		10A, 600VAC, 100KA I.R.
3		15A, 600VAC, 100KA I.R.
5		20A, 600VAC, 100KA I.R.

※Notice

- To avoid shock hazards, do not touch any electrical component when the power is applied or within five minutes after the power is disconnected. Any inspection should be performed after the charge indicator goes off.
- Do not perform wiring on the inverter with power on. Disregard of this notice may result in serious injury.

3.3.2 Contactor and Circuit Breaker specification and wiring.

Molded-case circuit breaker/magnetic contactor

- Teco bears no responsibility to service for failures caused by the following conditions:
 - (1) A molded-case circuit breaker is not installed, or an improper or overrated breaker is used, between the power source and the inverter.
 - (2) A magnetic contactor, a phase capacitor, or a burst absorber is connected between the inverter and the motor.

model: E310-□□□-XXX	2P5	201	202
Molded-case circuit breaker made by Teco	50E 10A	50E 20A	50E 30A
Magnetic contactor (MC) made by Teco	CN-11		
Main circuit terminals (TM1)	Wire gauge 2.0 mm ² terminal screw M3.5		
Signal terminals (TM2, TM3)	Wire gauge 0.80mm ² (# 18 AWG) terminal screw M3		

model: E310-□□□-XXX	401/402/403/405		
Molded-case circuit breaker made by Teco	50E 15A		
Magnetic contactor (MC) made by Teco	CN-11		
Main circuit terminals (TM1)	Wire gauge 2.0 mm ² terminal screw M3.5		
Signal terminals (TM2, TM3)	Wire gauge 0.80mm ² (# 18 AWG) terminal screw M3		

- Use three-phase squirrel cage induction motor with capacity suitable for the inverter.
- If one inverter is driving several motors, the total current of all motors running simultaneously must be less than the rated current of the inverter, and each motor has to be equipped with a proper thermal relay.
- Do not add capacitive components, such as a phase capacitors, LC or RC, between the inverter and the motor.

3.3.3 Precautions for peripheral applications:

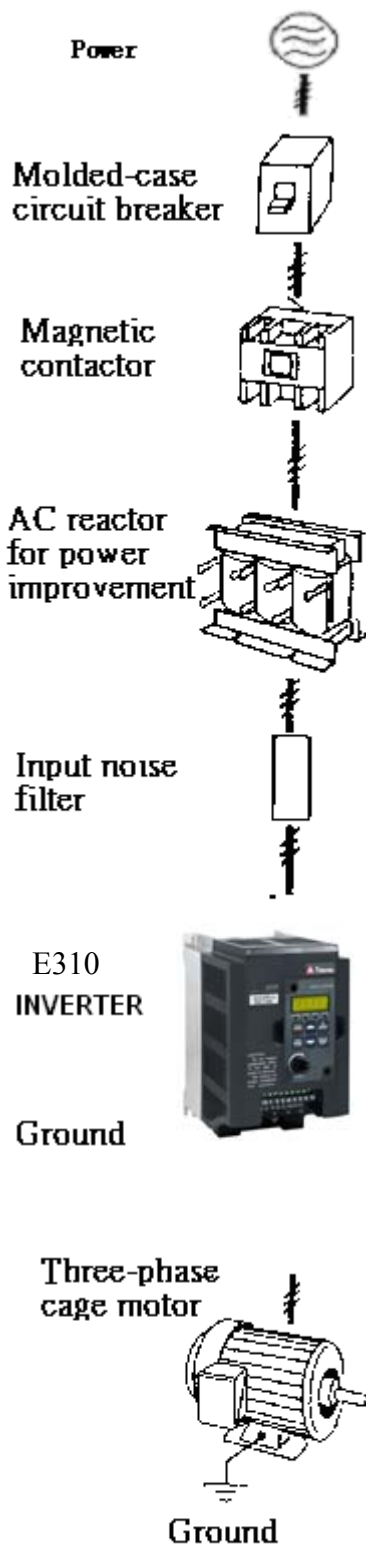

Power supply:

- Make sure the correct voltage is applied to avoid damaging the inverter.
- A molded-case circuit breaker or fused disconnect must be installed between the AC source and the inverter

Molded-case circuit breaker:

- Use a molded-case circuit breaker that conforms to the rated voltage and current of the inverter to control the power ON/OFF and protect the inverter.
- Do not use the circuit breaker as the run/stop switch for the inverter.

Leakage breaker:

- Install a leakage breaker to prevent problems caused by electric leakage and to protect personnel.
- Setting current should be 200mA or above and the operating time at 0.1 second or longer to prevent malfunctions.

Magnetic contactor:

- Normal operations do not need a magnetic contactor. However a contactor has to be installed in primary side when performing functions such as external control and auto restart after power failure, or when using a brake controller.
- Do not use the magnetic contactor as the run/stop switch of the inverter.

AC reactor for power quality improvement:

- When inverters below 200V/400V class 15KW are supplied with high capacity (above 600KVA) power source or an AC reactor can be connected to improve the power performance.

Install fast action fuse:

- To ensure the safety of peripheral devices, please install fast action fuse. Regarding the specification, please refer to P3-3.

Input noise filter:

- A filter must be installed when there are inductive loads affecting the inverter

Inverter:

- Input power terminals L1, L2, and L3 can be used in any sequence regardless of phase.
- Output terminals T1, T2, and T3 are connected to U, V, and W terminals of the motor. If the motor is reversed while the inverter is set to run forward, just swap any two terminals of T1, T2, and T3.
- To avoid damaging the inverter, do not connect the input terminals T1, T2, and T3 to AC input power.
- Connect the ground terminal properly. 200V class: class 3 grounding, <math><100\Omega</math>; 400V class : <math><10\Omega</math>.

Figure 3-3 Typical Installation Schematic

Make external connections according to the following instruction. Check connections after wiring to make sure all connections are correct. (Do not use the control circuit buzzer to check connections)
 (A) Main circuit's wiring must be separated from other high voltage or high current power line to avoid noise interference. Refer to the figures below:

Figure 3-4a) Installation Examples

- The inverter uses dedicated power line

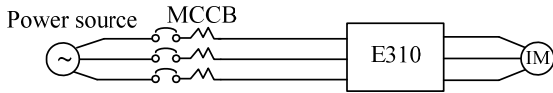

- Add a noise filter or separation transformer when sharing the power line with other machines.

- The inverter shares the power line with other machines

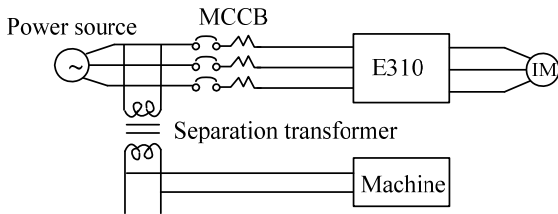
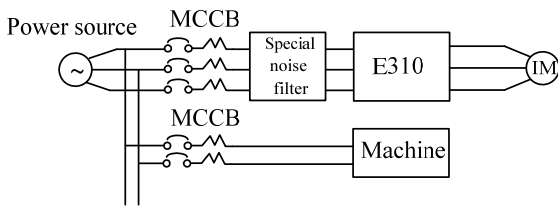

correct

- A general noise filter may not provide correct results

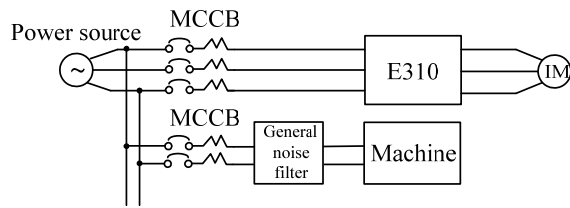

Incorrect

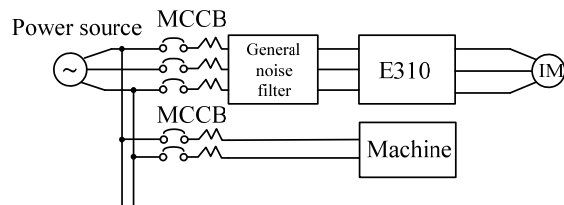

Incorrect

Figure 3-4b) Installation Examples using a filter and Isolation transformer

- A noise filter in the output of the main circuit can suppress conducted noise.
- To prevent radiated noise, the wires should be put in a metal pipe and distance from signal lines of other control equipment should be more than 30 cm.

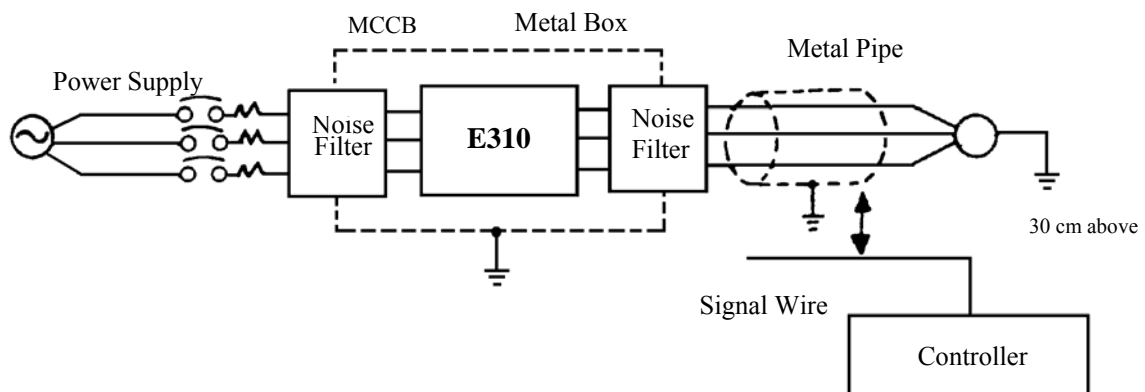

Figure 3-4c) Installation Examples with Adjacent Signal Conductors

- When the connection between the inverter and the motor is too long , consider the voltage drop of the cables. Phase-to-phase voltage drop (V) = $\sqrt{3} \times \text{resistance of wire } (\Omega/\text{km}) \times \text{length of line (m)} \times \text{current} \times 10^{-3}$.
- Carrier frequency must be adjusted based on the motor cable length.

Cable length between the inverter and the motor	Below 150ft	Below 300ft	Above 300ft
Recommended carrier frequency	Below 12KHz	Below 8KHz	Below 5KHz
Setting of parameter 10-03	12	8	5

(B) The control circuit wiring must be separated and routed away from the main circuit control line or other high voltage or current power lines to avoid noise interference

- To avoid erroneous operation caused by noise interference, shield the control circuit wiring with twisted-wires, and connect the shielded wire to a ground terminal. Refer to the figure below. The wiring distance should not exceed 50 meters.

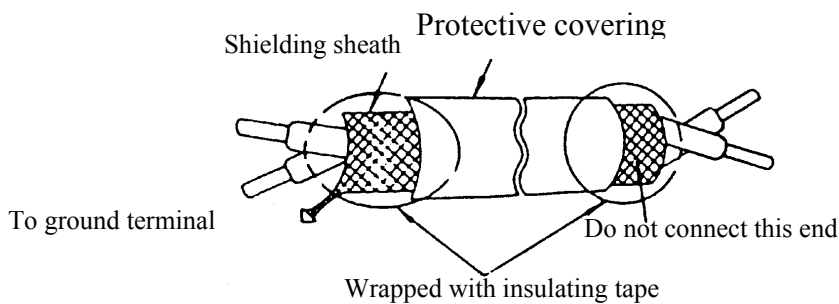

Figure 3-5 Control Cable requirements

(C) Inverter Ground terminal must be connected to installation ground correctly and according to the required local wiring regulations.

For 200V class ground resistance should be 100Ω or less.

For 400V class ground resistance should be 10Ω or less.

- Ground cable size must be according to the required local wiring regulations. The shorter the better.
- Do not share the ground of the inverter with other high current loads (Welding machine, high power motor). Connect the terminals to their own ground.
- Do not make a loop when several inverters share a common ground point.

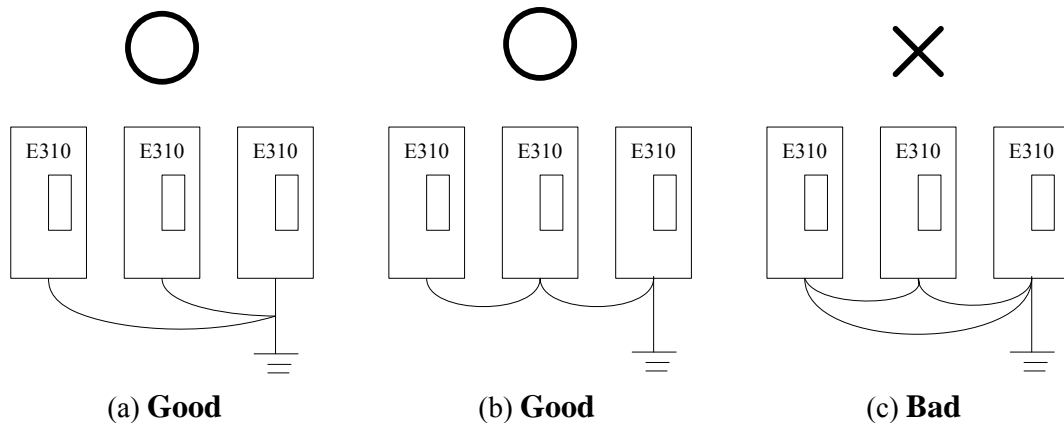

Figure 3-6 Grounding Examples

(D) To ensure maximum safety, use correct wire size for the main power circuit and control circuit. (According to the required local regulations)

(E) Verify that all wiring is correct, wires are intact, and terminal screws are secured.

3.4 Specifications

3.4.1 Product Specifications

Single / Three phase, 200-240V model

Model: E310-□□□-XXX	2P5	201	202
Horsepower(HP)	0.5	1	2
Max Applicable Motor Output (KW)	0.4	0.75	1.5
Rated Output Current(A)	3.1	4.5	7.5
Rated Capacity(KVA)	1.2	1.7	2.9
Max Applicable Motor Output (KW)	Single/Three Phase: 200~240V +10% -15%, 50/60Hz ± 5%		
Max. Output Voltage	Three Phase: 200~240V		
Net Weight (KG)	1.37	1.37	1.47
Allowable momentary power loss time (second)	1.0	1.0	2.0

Three phase, 380 – 480V model

Model: E310-□□□-XXX	401	402	403	405
Horsepower(HP)	1	2	3	5
Max Applicable Motor Output (KW)	0.75	1.5	2.2	3.7
Rated Output Current(A)	2.3	3.8	5.2	8.8
Rated Capacity(KVA)	1.7	2.9	4.0	6.7
Max Applicable Motor Output (KW)	Three phase: 380~480V +10% -15%, 50/60Hz ± 5%			
Max. Output Voltage	Three phase : 380~480V			
Net Weight (KG)	1.33	1.35	2.22	2.25
Allowable momentary power loss time (second)	1.0	1.0	2.0	2.0

3.4.2 General Specifications

	Item	E310
	Control Mode	V/F or Vector Control
Frequency Control	Range	0.01~400.00 Hz
	Start control torque	150%/1Hz (Vector)
	Speed control range	1:100 (Vector)
	Speed Control Precision	±0.5% (Vector)
	Setting resolution	Digital: 0.01Hz, Analog: 0.06Hz/ 60Hz(10bits)
	Keypad setting	Set directly with ▲ ▼ keys or the VR on the keypad
	Display Function	Five digital LED and status indicator; display frequency/ line speed/ DC voltage/ Output voltage/ Current/ Rotation direction/ Inverter parameter/ Fault Log/ Program Version / Heat sink temperature/PID feed back
	External signal setting	1. External potentiometer 0-10V/ 0-20mA 2. Provides up/down controls, speed control or automatic procedure control with multifunctional contacts on the terminal block (TM2)
	Frequency Limit Function	Upper/lower frequency limits and three programmable skip frequencies
	Carrier frequency	1 ~ 12 kHz
	V/F pattern	18 fixed patterns, 1 programable curve
	Acc/Dec control	Two-stage Acc/Dec time (0.1 – 3,600 seconds) and four-stage S curves (refer to descriptions on 10-07.)
	Multifunction analog output	5 functions (refer to description on 2-12)
	Multifunction input	22 functions (refer to description on 01-00~01-05)
	Multifunction output	14 functions (refer to description on 01-09~01-10)
	Other Functions	Momentary Power Loss Restart, Speed Search, Overload Detection, 8 preset speeds. Acc/Dec Switch (2 Stages), S Curves, 3-wire Control, PID control, torque boost, Slip Compensation, Frequency Upper/ Lower Limit, Auto energy saving, Modbus slave and PC/PDA Link, Auto Restart, Encoder input.

Item	E310	
Communication Control	<ol style="list-style-type: none"> Control by RS485 One to one or one to many control. BAUD RATE/STOP BIT/PARITY/bit can be set 	
Braking Torque	About 20% , the model below 20HP with built-in braking transistor and the specified external braking resistors can provide 100%	
Operation temperature	14-120°F(-10 ~ 50°C)	
Storage temperature	4-140°F(-20 ~ 60°C)	
Humidity	0 – 95% Relative Humidity(Non-condense)	
Vibration	1G (9.8m/ S ²)	
Enclosure	IP20	
Protective Functions	Overload protection	The relays to protect the motor (the curve can be set) and the inverter (150 % / 1min)
	Over Voltage	200V class: DC Voltage > 410V 400Vclass: DC Voltage > 820V
	Under Voltage	200V class: DC Voltage < 190V 400Vclass: DC Voltage < 380V
	Momentary Power Loss Restart	Restart can be initiated with spin start after momentary power loss in Max 2 sec.
	Stall Prevention	Stall prevention for Acceleration/ Deceleration/ Operation.
	Short-circuit output terminal	Electronic Circuit Protection
	Grounding Fault	Electronic Circuit Protection
	Other Function	Protection for overheating of heat sink, over torque detection, error contact control, reverse prohibit, prohibit for direct start after power up and error recovery, parameter lock up.

3.5 Wiring diagram E310 series inverter

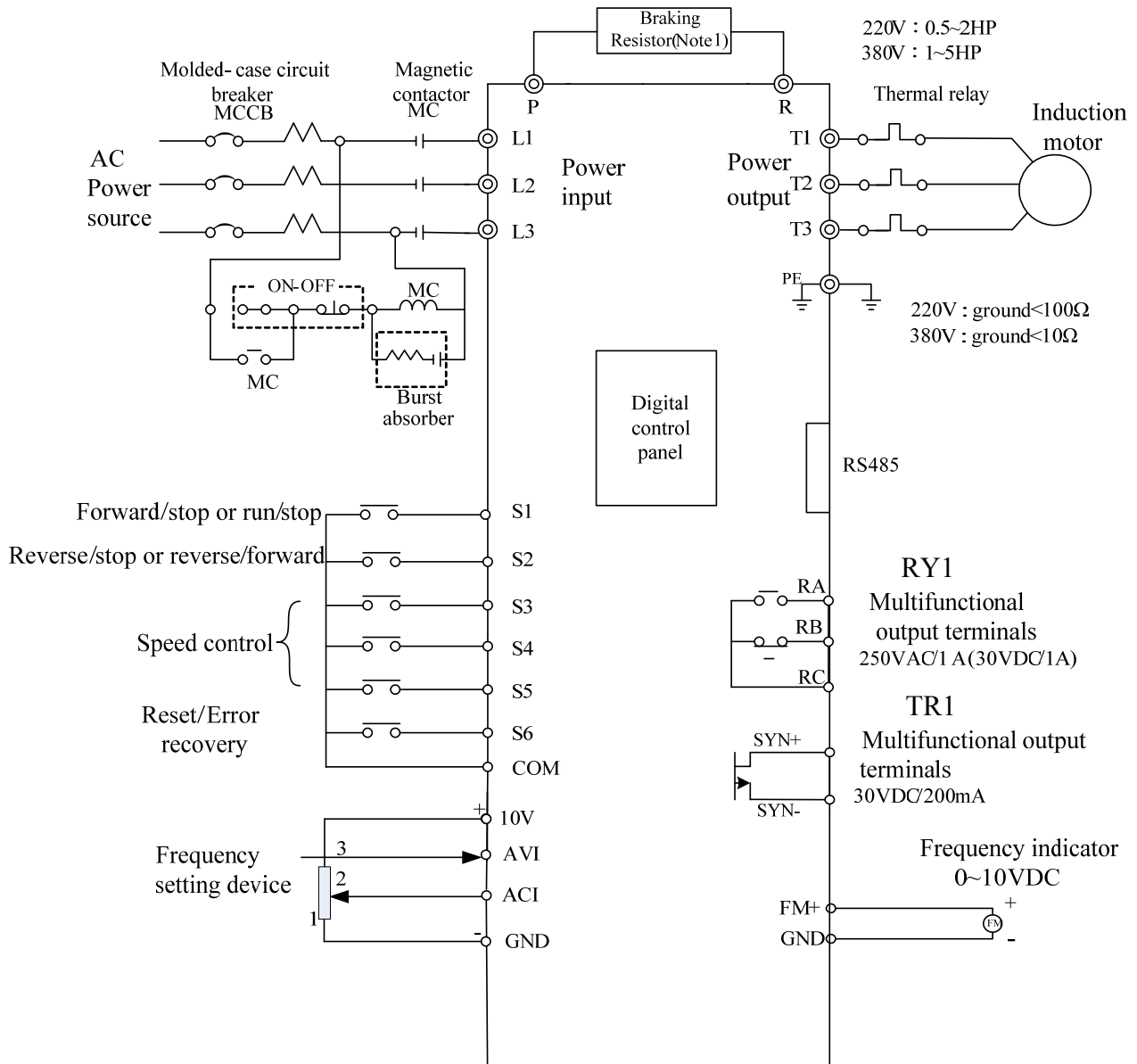

Figure 3-7 Wiring Diagram

Note 1: Please refer to description of main circuit terminals (P, R) and specification of braking resistor for value selection.

2: please avoid connecting output of inverter to the earth.

3.6 Description of connection terminals

Descriptions of main circuit terminals

	Symbol	Description	
TM1	L1	Main power input	Single-phase: L1/ L2 Three-phase: L1/L2/L3
	L2		
	L3		
	P	Braking resistor connection terminal: Used in applications when it is required to stop a high inertia load rapidly. (refer to specifications of the braking resistor)	220V:0.5~2HP, 380V:1~5HP
	R		
	T1	Inverter outputs	
	T2		
T3			

Descriptions of E310 control circuit terminals

	Symbol	Description		
TM2	RA	Normal open contact	Multifunctional output terminals	Contact rated capacity: (250VAC/1A or 30VDC/1A) Contact using description: (refer to parameters 01-09, 01-10)
	RB	Normal close contact		
	RC	Common contact		
	10V	Frequency knob (VR) power source terminal (pin 3)		
	AVI	Analog frequency signal input terminal AVI (0~10VDC/2~10VDC)		
	ACI	PID signal input terminal or Bias signal input terminal ACI(0~20mA /4~20mA)		
	GND	ground		
	SYN+	Positive terminal for multi-function output	30VDC/200mA	
	SYN-	Negative terminal for multi-function output		
TM3	COM	Common for digital input signal for S1~S6 input.		
	S1	multifunction input terminals (refer to parameter 1-00~1-02 description)		
	S2			
	S3			
	COM	Common for digital input signal for S1~S6 input.		
	S4	multifunction input terminals (refer to parameter 1-03~1-05 description)		
	S5			
	S6			
FM+	The positive multifunction analog output signal for multifunction (refer to parameter 2-12 description), the signal for output terminal is 0-10VDC (below 2mA).			

3.7 Outline Dimensions (unit: mm)

(1) Frame1 : single /Three phase: E310-2P5/201/202 Three phase: E310-401/402

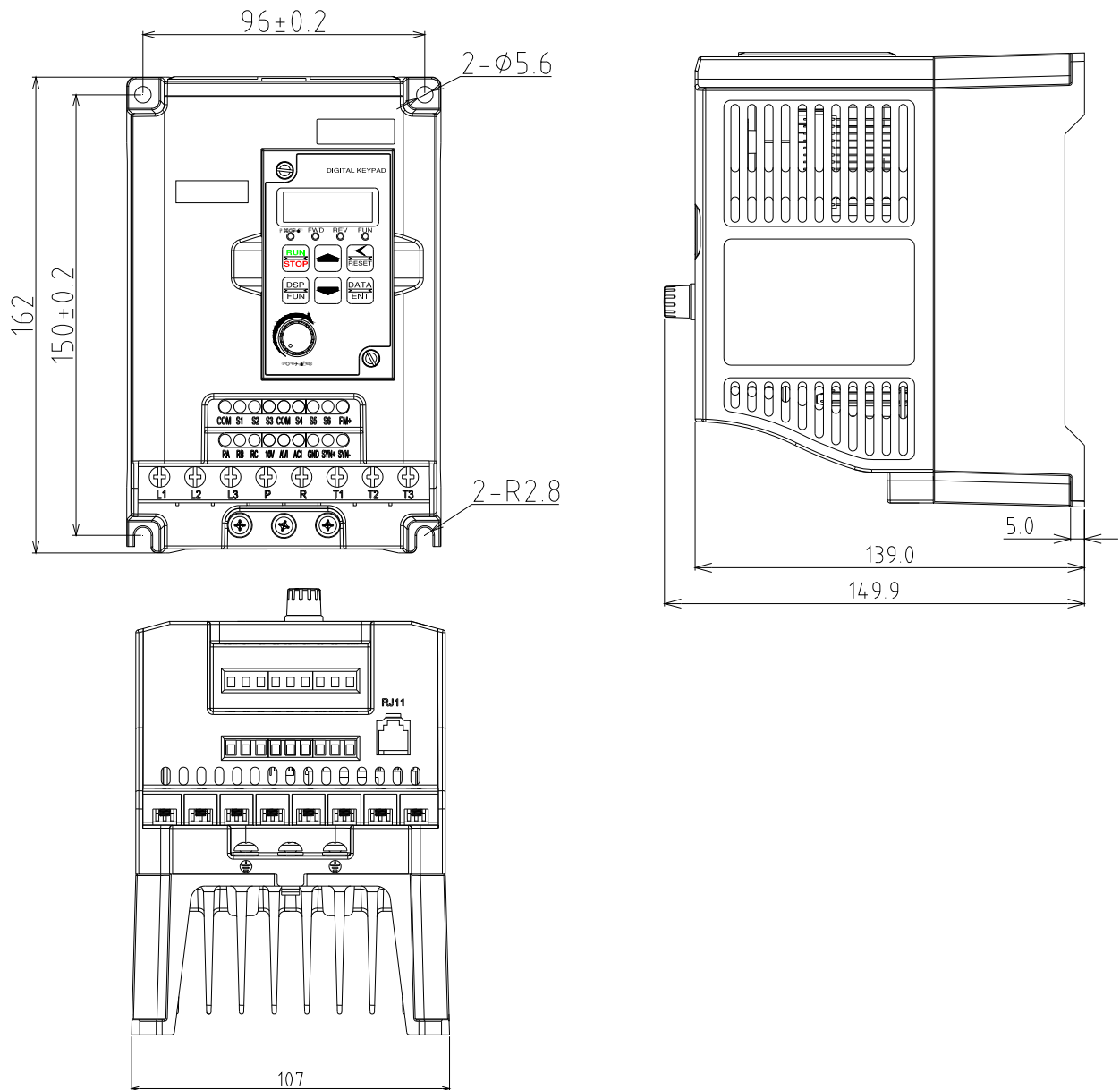

Figure 3-8 Frame size 1 Dimensions

E310-2P5/201/202/401/402

(2) Frame2 : Three phase E310-403/405

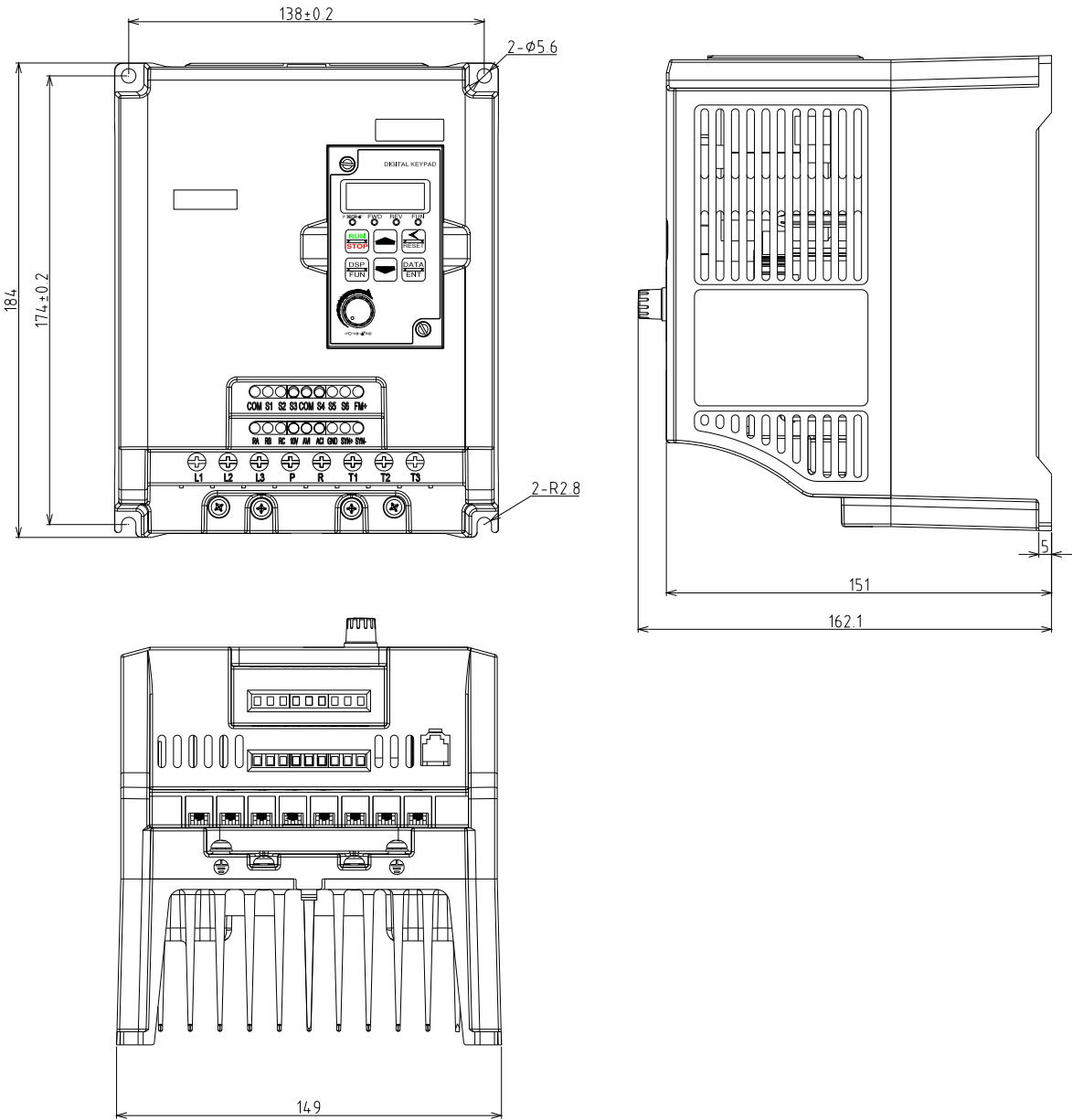

Figure 3-9 Frame size 2 Dimensions

MODEL : E310-403/405

Chapter 4 Software Index

4.1 Keypad Description

4.1.1 Keypad Display and Operation Instruction

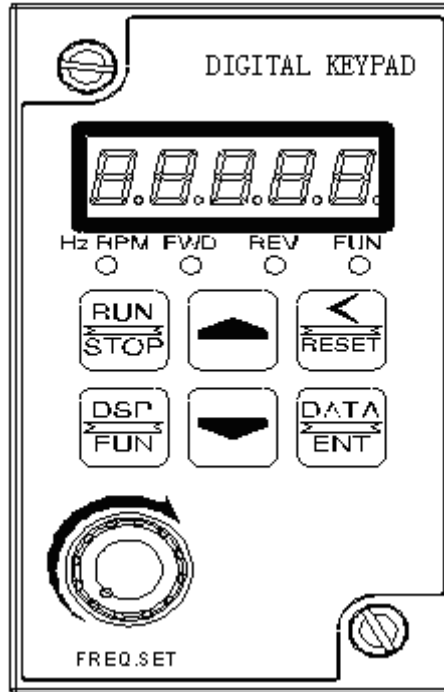

Figure 4-1 Keypad Layout

1. Four actions of FUN mode : Hz/RPM, and display of five 7-segment display. (Refer to operation description of the keypad).
2. FWD LED : Forward Direction, LED action (Flash while stopped, solid Lit during operation).
3. REV LED : Reverse Direction, LED action (Flash while stopped, solid Lit during operation).

⚠ Caution

To avoid keypad damage, do not operate it with a screwdriver or any sharp and hard tool.

4.1.2 Operation Instruction of the LED keypad

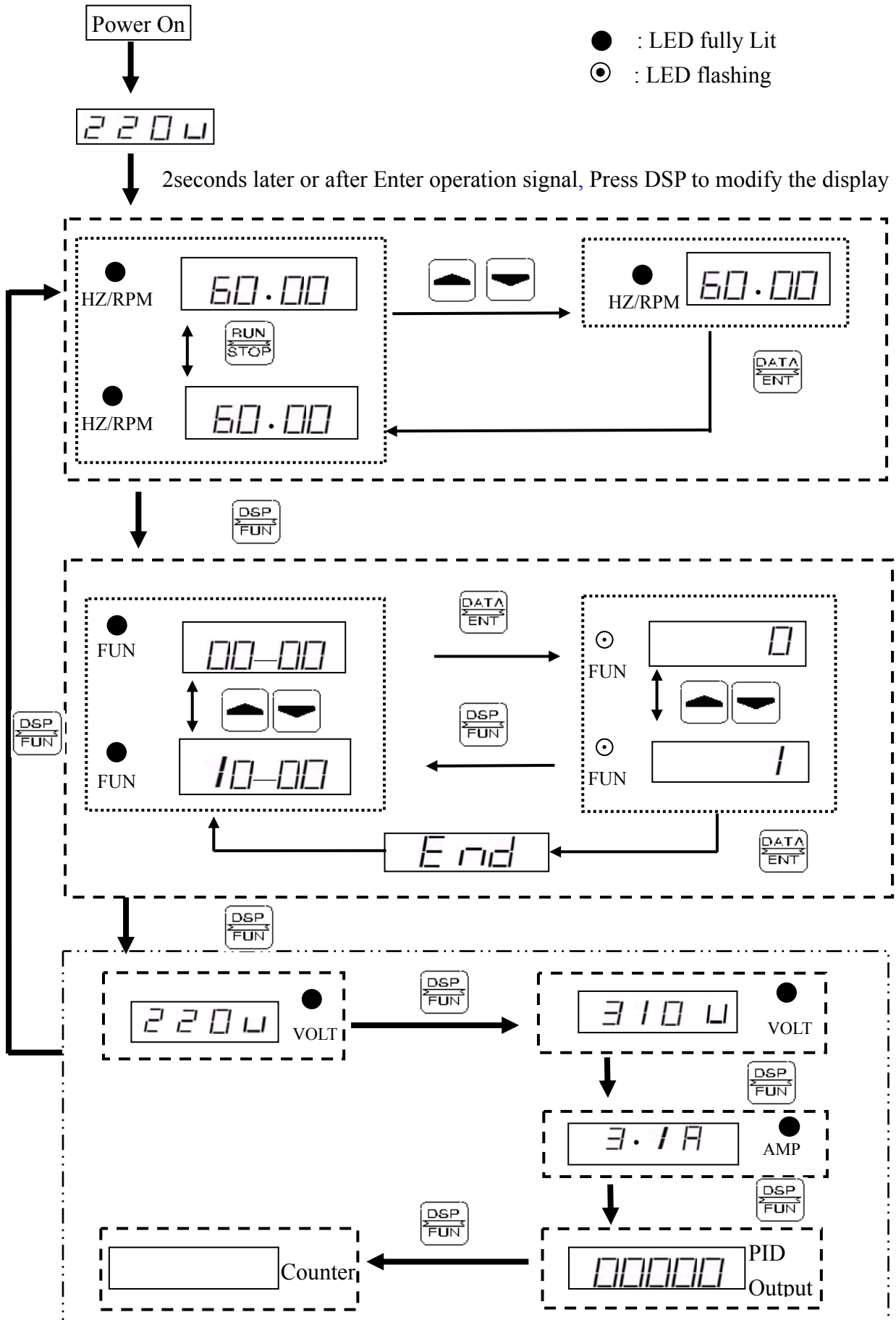

Figure 4-2 LED Keypad Operations Sequence

4.2 Control Mode Selection

The E310 Series inverter has two control modes :

1. V/F Control Mode.
2. General Vector Control Mode.

The user can choose these modes with the digital keypad according to the application requirement. The factory setting is V/F Control Mode. Before operation, please set the control mode and the related motor parameters in accordance with the following flow chart. (The Vector control mode is suitable for the motors with the same power rating as the inverter, or one size bigger or smaller if necessary).

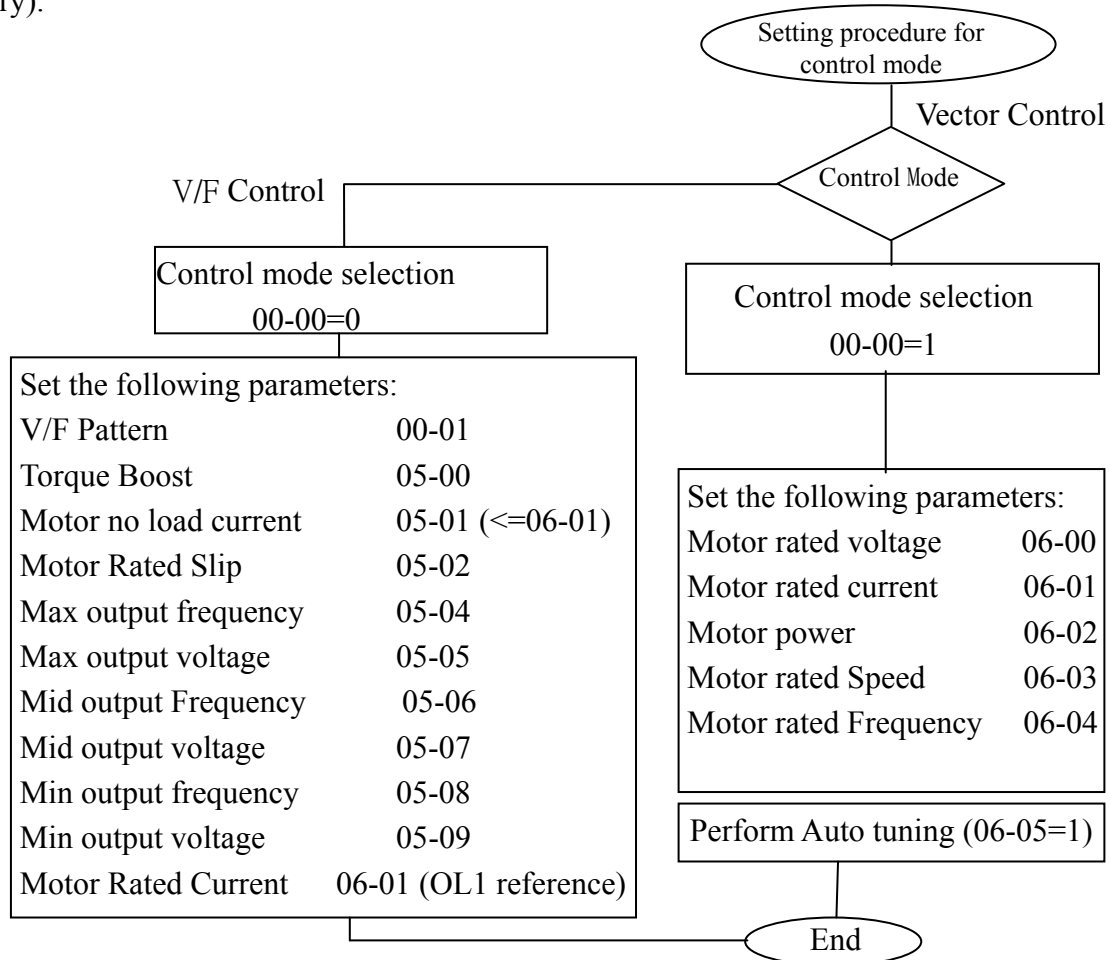

※Note : Figure 4-3 Control Mode Selection Chart

1. Use V/F Control Mode :
 - (1) Use one inverter to drive several motors simultaneously
 - (2) Motor's nameplate is unknown or motor's specifications are too special, it will cause Auto-tuning fault.
 - (3) Specification of inverter and motor differs by more than 1 size.
2. One inverter drives several motors (Only in V/F mode), set the motor parameters according to the following rules :
 - (1). Sum the rated current of all motors for total inverter current.
 - (2). Input correct VF Pattern parameter (05-04~05-09).
3. When the nameplate of the motor is unknown, the inverter will be set by default to parameters according to the standard TECO motor.
4. When parameter 00-00=0, the keypad will display 'Err2' when performing Auto tuning.
5. In VECTOR MODE, the max. & min. value of 06-01~06-05 will be limited by one size higher or lower than TECO standard motor specification. In VF MODE control, there is no limitation.

4.3E310 Programmable Functions List

Parameter Group No.	Description
00-	The basic parameters group
01-	External terminal digital signal input function group
02-	External terminal analog signal input function group
03-	Preset Frequency function group
04-	Start/Stop command group
05-	V/F command group
06-	Motor parameter group
07-	Protection function group
08-	Communication function group
09-	PID function group
10-	Assistant function group
11-	Keypad display group
12-	User parameter group
13-	Auto Run(Auto Sequencer) function group

0- The basic parameters group

FunctionCode No.	Description	Range/Code	Factory Setting	Remarks
00-00	Control Mode	0 : Volts/Hz 1 : Vector	0	
00-01	Volts/Hz Patterns(V/F)	0~18	0/9	*5
00-02	Motor rotation	0 : Forward 1 : Reverse	0	*1
00-03	Main Run Command Source Selection	0 : Keypad 1 : External Run/Stop Control 2 : Communication	0	
00-04	Subsidiary Run Command Source Selection	0 : Keypad 1 : External Run/Stop Control 2 : Communication	0	
00-05	Main Frequency Command Source Selection	0 : Keypad 1 : Potentiometer on Keypad 2 : External AVI Analog Signal Input 3 : External Up/Down Frequency Control 4 : Communication setting Frequency	0	

FunctionCode No.	Description	Range/Code	Factory Setting	Remarks
00-06	Subsidiary Frequency Command Source Selection	0 : Keypad 1 : Potentiometer on Keypad 2 : External AVI Analog Signal Input 3 : External Up/Down Frequency Control 4 : Communication setting Frequency	0	
00-07	Frequency Upper Limit (Hz)	0.01~400.00	50.00/60.00	
00-08	Frequency Lower Limit (Hz)	0.01~399.99	0.00	
00-09	Acceleration Time 1(S)	0.1~3600.0	10.0	*1
00-10	Deceleration Time 1(S)	0.1~3600.0	10.0	*1
00-11	Operation modes for external terminals	0 : Forward/Stop-Reverse/Stop 1 : Run/Stop-Forward/Reverse 2 : 3-Wire Control Mode-Run/Stop	0	
00-12	Jog Frequency (Hz)	0.00~25.00	2.00	*1
00-13	Jog Acceleration Time (MFIT) (S)	0.1~25.5	0.5	*1
00-14	Jog Deceleration Time (MFIT) (S)	0.1~25.5	0.5	*1

1- External terminal digital signal input function group

FunctionCode No.	Description	Range/Code	Factory Setting	Remarks
01-00	Multifunction Input Term. S1	0 : Forward/Stop Command	0	
01-01	Multifunction Input Term. S2	1 : Reverse/Stop Command	1	
01-02	Multifunction Input Term. S3	2 : Preset Speed unit 0 (3-02)	2	
01-03	Multifunction Input Term. S4	3 : Preset Speed unit 1 (3-03)	3	
01-04	Multifunction Input Term. S5	4 : Preset Speed unit 2 (3-05)	4	
01-05	Multifunction Input Term. S6	5 : Jog Forward Command 6 : Jog Reverse Command 7 : Acc/Dec 2 8 : Emergency Stop 9 : Base Block 10 : Main/Alt run Command select 11 : Acc/Dec Disabled 12 : Up Command 13 : Down Command 14 : Main/Alt Frequency Command select 15 : PID Function Disabled 16 : Integration Value Resets to Zero 17 : Reset 18 : KEB function 19 : Auto _ Run Mode 20 : Counter Trigger Signal 21 : Counter Reset	17	
01-06	Multifunction terminal S1 ~ S6 confirm the scan times	1~ 200(X 4ms)	5	
01-07	Up/Down (Hz)	0.00~ 5.00	0.00	

FunctionCode No.	Description	Range/Code	Factory Setting	Remarks
01-08	Up/Down keep Frequency mode	0 : When Up/Down is used, the preset frequency is held as the inverter stops, and the UP/Down function is disabled. 1 : When Up/Down is used, the preset frequency is reset to 0 Hz as the inverter stops. 2 : When Up/Down is used, the preset frequency is held as the inverter stops, and the UP/Down is available.	0	
01-09	Output Relay RY1 Operation Mode	0 : Run	1	
01-10	Output Relay TR1 Operation Mode	1 : Fault 2 : Frequency Reached 3 : Set Frequency 4 : Frequency Threshold Level (> 1-11) - Frequency Reached 5 : Frequency Threshold Level (< 1-11) - Frequency Reached 6 : Auto Restart 7 : Momentary AC Power Loss 8 : Emergency Stop Mode 9 : Base Block Stop Mode 10 : Motor Overload Protection(OL1) 11 : Drive Overload Protection(OL2) 12 : PID Feedback Signal Loss 13 : Top Count Value Attained	0	
01-11	Frequency Output Setting (Hz)	0.00 ~ 400.00	0.00	*1
01-12	Frequency Detection Range	0.00 ~ 30.00	2.00	*1
01-13	S1~ S5 switch type select	xxxx0 : S1 NO xxxx1 : S1 NC xxx0x : S2 NO xxx1x : S2 NC xx0xx : S3 NO xx1xx : S3 NC x0xxx : S4 NO x1xxx : S4 NC 0xxxx : S5 NO 1xxxx : S5 NC	00000	
01-14	S6 switch type select	xxxx0 : S6 NO xxxx1 : S6 NC	00000	

※ “NO”: Normal open, “NC”: Normal close.

2- External terminal analog signal input function group

Function Code No.	Description	Range/Code			Factory Setting	Remarks
02-00	AVI/ACI analog Input signal type select	setting	AVI	ACI	0	
		0	0~10V	0~20mA		
		1	0~10V	4~20mA		
		2	2~10V	0~20mA		
		3	2~10V	4~20mA		
02-01	AVI Signal Verification Scan	1 ~ 100(x 4ms)			50	
02-02	AVI Gain (%)	0 ~1000			100	*1
02-03	AVI Bias (%)	0 ~100			0	*1
02-04	AVI Bias Selection	0 : Positive 1 : Negative			0	*1
02-05	AVI Slope	0 : Positive 1 : Negative			0	*1
02-06	ACI function Select	0 : PID feedback signal 1 : ACI Bias signal input			0	
02-07	ACI Signal Verification Scan	1 ~ 100(x 4ms)			50	
02-08	ACI Gain (%)	0 ~1000			100	*1
02-09	ACI Bias (%)	0.0 ~100.0			0.0	*1
02-10	ACI Bias Selection	0 : Positive 1 : Negative			0	*1
02-11	ACI Slope	0 : Positive 1 : Negative			0	*1
02-12	Analog Output Mode(FM+)	0 : Output Frequency 1 : Frequency Setting 2 : Output Voltage 3 : DC Bus Voltage 4 : Motor Current			0	*1
02-13	Analog Output FM+ Gain (%)	0 ~1000			100	*1
02-14	Analog Output FM+ Bias (%)	0 ~100			0	*1
02-15	FM+ Bias Selection	0 : Positive 1 : Negative			0	*1
02-16	FM+ Slope	0 : Positive 1 : Negative			0	*1

3-preset Frequency function group

Function Code No.	Description	Range/Code	Factory Setting	Remarks
03-00	Preset Speed Control mode Selection	0 : common (Is uniform time(Acc1/Dec1or Acc2/Dec2) 1 : special (is single time Acc0/Dec0~ Acc7/Dec7)	0	

Function Code No.	Description	Range/Code	Factory Setting	Remarks
03-01	Preset Speed 0 (Hz)	0.00 ~ 400.00	5.00	Keypad Freq
03-02	Preset Speed1 (Hz)	0.00 ~ 400.00	5.00	*1
03-03	Preset Speed2 (Hz)	0.00 ~ 400.00	10.00	*1
03-04	Preset Speed3 (Hz)	0.00 ~ 400.00	20.00	*1
03-05	Preset Speed4 (Hz)	0.00 ~ 400.00	30.00	*1
03-06	Preset Speed5 (Hz)	0.00 ~ 400.00	40.00	*1
03-07	Preset Speed6 (Hz)	0.00 ~ 400.00	50.00	*1
03-08	Preset Speed7 (Hz)	0.00 ~ 400.00	60.00	*1
03-09~ 03-16	Reserved		Reserved	
03-17	Preset Speed0-Acctime(s)	0.1 ~ 3600.0	10.0	*1
03-18	Preset Speed0-Dectime(s)	0.1 ~ 3600.0	10.0	*1
03-19	Preset Speed1-Acctime(s)	0.1 ~ 3600.0	10.0	*1
03-20	Preset Speed1-Dectime(s)	0.1 ~ 3600.0	10.0	*1
03-21	Preset Speed2-Acctime(s)	0.1 ~ 3600.0	10.0	*1
03-22	Preset Speed2-Dectime(s)	0.1 ~ 3600.0	10.0	*1
03-23	Preset Speed3-Acctime(s)	0.1 ~ 3600.0	10.0	*1
03-24	Preset Speed3-Dectime(s)	0.1 ~ 3600.0	10.0	*1
03-25	Preset Speed4-Acctime(s)	0.1 ~ 3600.0	10.0	*1
03-26	Preset Speed4-Dectime(s)	0.1 ~ 3600.0	10.0	*1
03-27	Preset Speed5-Acctime(s)	0.1 ~ 3600.0	10.0	*1
03-28	Preset Speed5-Dectime(s)	0.1 ~ 3600.0	10.0	*1
03-29	Preset Speed6-Acctime(s)	0.1 ~ 3600.0	10.0	*1
03-30	Preset Speed6-Dectime(s)	0.1 ~ 3600.0	10.0	*1
03-31	Preset Speed7-Acctime(s)	0.1 ~ 3600.0	10.0	*1
03-32	Preset Speed7-Dectime(s)	0.1 ~ 3600.0	10.0	*1

04-start/stop command group

Function Code No.	Description	Range/Code	Factory Setting	Remarks
04-00	Starting Method Selection	0 : Normal Start 1 : Enable Speed Search	0	
04-01	Stopping Method Selection	0 : braking capacity 1 : Coast to stop	0	
04-02	Keypad Stop Button	0 : Stop Button Enabled 1 : Stop Button Disabled	0	

Function Code No.	Description	Range/Code	Factory Setting	Remarks
04-03	Momentary Power Loss and Restart	0 : Momentary Power Loss and Restart disable 1 : Momentary power loss and restart enable 2 : Momentary power loss and restart enable while CPU is operating. (According to the capacity of DC power)	0	
04-04	Momentary Power Loss Ride-Thru Time (Seconds)	0.0 - 2.0	0.5	
04-05	Auto Restart Method	0 : Enable Speed Search 1 : Normal Start	0	
04-06	Auto Restart Delay Time (Seconds)	0.0 - 800.0	0.0	
04-07	Number of Auto Restart Attempts	0-10	0	
04-08	Reset Mode Setting	0 : Enable Reset Only when Run Command is Off 1 : Enable Reset when Run Command is On or Off	0	
04-09	Direct Running After Power Up	0 : Enable Direct running after power up 1 : Disable Direct running after power up	1	
04-10	Delay-ON Timer (Seconds)	1.8 ~300.0	1.0	
04-11	Kinetic Energy Back-up Deceleration Time	0.0 : Disable 0.1~25.0 : KEB Deceleration Time	0.0	
04-12	Lower Limit of Power Voltage Detect	150.0~210.0/300.0~420.0	190.0/380.0	
04-13	DC Injection Brake Level (%)@start	0.0~150.0	50.0	
04-14	DC Injection Brake Time (Seconds) @start	0.0~25.5	0.5	
04-15	DC Injection Brake Start Frequency (Hz) @stopped	0.10~10.00	1.50	
04-16	DC Injection Brake Level(%)@Stopped	0.0~150.0	50.0	
04-17	DC Injection Brake Time (Seconds) @stopped	0.0~25.5	0.5	

05-V/F command group

Function Code No.	Description	Range/Code	Factory Setting	Remarks
05-00	Volts/Hz Curve Modification (Torque Boost) (%)	0 ~ 30.0	10.0	*5
05-01	Motor No Load Current(Amps AC)	-----		*5

Function Code No.	Description	Range/Code	Factory Setting	Remarks
05-02	Motor rated Slip Compensation (%)	0.0 ~ 100.0	0.0	*5
05-03	v/f max voltage	220V series : 170.0 ~ 264.0 440V series : 323.0 ~ 528.0		*5
05-04	Maximum Frequency (Hz)	0.20 ~ 400.00	50.00/60.00	*5
05-05	Maximum Frequency VoltageRatio (%)	0.0 ~ 100.0	100.0	*5
05-06	Medium Frequency 2(Hz)	0.10 ~ 400.00	25.00/30.00	*5
05-07	Medium Frequency Voltage Ratio2 (%)	0.0 ~ 100.0	50.0	*5
05-08	Medium Frequency1 (Hz)	0.10 ~ 400.00	10.00/12.00	*5
05-09	Medium Frequency Voltage Ratio1 (%)	0.0 ~ 100.0	20.0	*5
05-10	Minimum Frequency (Hz)	0.10 ~ 400.00	0.50/0.60	*5
05-11	Minimum Frequency VoltageRatio (%)	0.0 ~ 100.0	1.0	*5
05-12	V/F start Frequency	0.00 ~ 10.00	0.00	*5

06-Motor parameter group

Function Code No.	Description	Range/Code	Factory Setting	Remarks
06-00	Motor Rated Voltage (VAC)	-----		*4
06-01	Motor Rated Current (Amp AC)	-----		*4
06-02	Motor Rated Power (kW)	-----		*4
06-03	Motor Rated Speed (RPM)	-----		*4
06-04	Motor Rated Frequency (Hz)	-----		*4
06-05	Reserved		Reserved	
06-06	Torque Boost Gain (Vector)	0~ 600		*3*4
06-07	Slip Compensation Gain (Vector)	0 ~ 600		*3*4
06-08	Reserved		Reserved	
06-09	Reserved		Reserved	
06-10	Reserved		Reserved	
06-11	Low-frequency compensation Gain	0 ~ 100	30	

07-Protection function group

Function Code No.	Description	Range/Code	Factory Setting	Remarks
07-00	Trip Prevention Selection	xxxx0 : Enable Trip Prevention During Acceleration xxxx1 : Disable Trip Prevention During Acceleration xxx0x : Enable Trip Prevention During Deceleration xxx1x : Disable Trip Prevention During Deceleration xx0xx : Enable Trip Prevention in Run Mode xx1xx : Disable Trip Prevention in Run Mode x0xxx : Enable over voltage Prevention in Run Mode x1xxx : Disable over voltage Prevention in Run Mode	00000	
07-01	Trip Prevention Level During Acceleration (%)	50 ~ 200	200	Inverter Rated Current 200%
07-02	Trip Prevention Level During Deceleration (%)	50 ~ 200	200	Inverter Rated Current 200%
07-03	Trip Prevention Level In Run Mode (%)	50 ~ 200	200	Inverter Rated Current 200%
07-04	over voltage Prevention Level in Run Mode	350.0 VDC ~ 390.0 VDC 700.0 VDC ~ 780.0 VDC	380.0/ 760.0	
07-05	Electronic Motor Overload Protection Operation Mode	0 : Enable Electronic Motor Overload Protection 1 : Disable Electronic Motor Overload Protection	1	
07-06	Motor type Selection	0 : Electronic Motor Overload Protection Set for Non-Inverter Duty Motor 1 : Electronic Motor Overload Protection Set for Inverter Duty Motor	0	
07-07	Motor Overload Protection Curve Selection	0 : Constant Torque (OL =103 %) (150 % for 1 Minute) 1 : Variable Torque (OL = 113 %) (123 % for 1 Minute)	0	
07-08	Operation After Overload Protection is Activated	0 : Coast-to-Stop After Overload Protection is Activated 1 : Drive Will Not Trip when Overload Protection is Activated (OL1)	0	
07-09	Over torque Detection Selection (OL3)	0 : Disable Over torque Operation 1 : Enable Over torque Operation Only if at Set Frequency 2 : Enable Over torque Operation while the Drive is in Run Mode	0	

Function Code No.	Description	Range/Code	Factory Setting	Remarks
07-10	Operation After Over torque Detection is Activated	0 : Coast-to-Stop After Over torque is Activated 1 : Drive will Continue to Operate After Over torque is Activated (OL3)	1	
07-11	Over torque Threshold Level(%)	30 ~ 300	160	
07-12	Over torque Activation Delay Time (S)	0.0 ~ 25.0	0.1	
07-13	OH over heat Protection (cooling fan control)	0 : Auto (Depends on temp.) 1 : Operate while in RUN mode 2 : Always Run 3 : Disabled	1	

08-Communication function group

Function Code No.	Description	Range/Code	Factory Setting	Remarks
08-00	Assigned Communication Station Number	1~ 32	1	*2*4
08-01	RTU code /ASCII code select	0 : RTU code 1 : ASCII code	0	*2*3
08-02	Baud Rate Setting (bps)	0 : 4800 1 : 9600 2 : 19200 3 : 38400	2	*2*3
08-03	Stop Bit Selection	0 : 1 Stop Bit 1 : 2 Stop Bits	0	*2*3
08-04	Parity Selection	0 : Without Parity 1 : With Even Parity 2 : With Odd Parity	0	*2*3
08-05	Data Format Selection	0 : 8-Bits Data 1 : 7-Bits Data	0	*2*3
08-06	Communication time-out detection time	0.0 ~ 25.5	0.0	
08-07	Communication time-out operation selection	0 : Deceleration to stop (00-10 : Deceleration time 1) 1 : Coast to stop 2 : Deceleration to stop (10-06 : Deceleration time 2) 3 : continue operating	0	
08-08	Err6 fault tolerance times	1 ~ 20	3	
08-09	Drive Transmit Wait Time (ms)	1 ~ 16(×4ms)	2	

09-PID function group

Function Code No.	Description	Range/Code	Factory Setting	Remarks
09-00	PID Mode Selection	0 : Disabled 1 : Bias D Control 2 : Feedback D Control 3 : Bias D Reversed Characteristics Control 4 : Feedback D Reversed Characteristics Control	0	
09-01	Feedback Gain coefficient	0.00 ~ 10.00	1.00	*1
09-02	Proportional Gain (%)	0.0 ~ 10.0	1.0	*1
09-03	Integration Time (S)	0.0 ~ 100.0	10.0	*1
09-04	Differentiation Time (S)	0.00 ~ 10.00	0.00	*1
09-05	PID Offset	0 : Positive 1 : Negative	0	*1
09-06	PID Offset Adjust (%)	0 ~ 109	0	*1
09-07	PID Output Lag Filter Time(S)	0.0 ~ 2.5	0.0	*1
09-08	Feedback Loss Detection Mode	0 : Disabled 1 : Enabled - Drive Continues to Operate After Feedback Loss 2 : Enabled - Drive "STOPS" After Feedback Loss	0	
09-09	Feedback Loss Detection Level (%)	0 ~100	0	
09-10	Feedback Loss Detection Delay Time (S)	0.0 ~ 25.0	1.0	
09-11	Integration Limit Value (%)	0 ~ 109	100	*1
09-12~09-13	Reserved		Reserved	
09-13	Allowable Integration Error Margin (Units) (1 Unit = 1/8192)	0 ~100	0	
09-14	Sleep Frequency Level	0.00 ~ 400.00	0.00	
09-15	Sleep Function Delay Time	0.0 ~ 25.5	0.0	
09-16	Wake up frequency Level	0.00 ~ 400.00	0.00	
09-17	Wake up function Delay Time	0.0 ~ 25.5	0.0	

10-Assistant function group

Function Code No.	Description	Range/Code	Factory Setting	Remarks
10-01	Reverse operation control	0 : Reverse command is enabled 1 : Reverse command is disabled	0	
10-02	Keypad Operation with Up/Down Keys in Run Mode	0 : 'Enter' must be pressed after Frequency change with Up/Down Keys on keypad. 1 : Frequency will be changed directly when Up/Down Keys are Pressed	0	
10-03	Carrier Frequency (kHz)	1~ 12	5	

Function Code No.	Description	Range/Code	Factory Setting	Remarks
10-04	Carrier mode Selection	0 : Carrier mode0 3-phase PW M modulation 1 : Carrier mode1 2-phase PW M modulation 2 : Carrier mode2 2-phase randomized PW M modulation	1	
10-05	Acceleration Time 2 (MFIT) (s)	0.1 ~ 3600.0	10.0	*1
10-06	Deceleration Time 2 (MFIT) (s)	0.1 ~ 3600.0	10.0	*1
10-07	S-Curve Acc/Dec 1 (s)	0.0 ~ 4.0	0.2	
10-08	S-Curve Acc/Dec 2(s)	0.0 ~ 4.0	0.2	
10-09	S-Curve Acc/Dec 3 (s)	0.0 ~ 4.0	0.2	
10-10	S-Curve Acc/Dec 4 (s)	0.0 ~ 4.0	0.2	
10-11	Skip Frequency 1 (Hz)	0.00 ~ 400.00	0.00	*1
10-12	Skip Frequency 2 (Hz)	0.00 ~ 400.00	0.00	*1
10-13	Skip Frequency 3 (Hz)	0.00 ~ 400.00	0.00	*1
10-14	Skip Frequency Bandwidth (±Hz)	0.00 ~ 30.00	0.00	*1
10-15	Carrier Frequency Reduction by temperature raising	0 : disabled 1 : enabled	0	
10-16	Auto Voltage Regulation (AVR)	0 : AVR function disabled 1 : AVR function enabled	1	
10-17	Count Down Completion	0 ~9999	0	

11-Keypad display group

Function Code No.	Description	Range/Code	Factory Setting	Remarks
11-00	Display Mode	xxxx0 : Disable Motor Current Display xxxx1 : Enable Motor Current Display xxx0x : Disable Motor Voltage Display xxx1x : Enable Motor Voltage Display xx0xx : Disable Bus Voltage Display xx1xx : Enable Bus Voltage Display x0xxx : Disable temperature Display x1xxx : Enable temperature Display 0xxxx : Disable PID feedback Display 1xxxx : Enable PID feedback Display	00000	*1
11-01	Custom Units (Line Speed) Value	0~65535	1800	*1
11-02	Custom Units (Line Speed) Display Mode	0 : Drive Output Frequency is Displayed 1 : Line Speed is Displayed in Integer (xxxxx) 2 : Line Speed is Displayed with One Decimal Place (xxxx.x) 3 : Line Speed is Displayed with Two Decimal Places (xxx.xx) 4 : Line Speed is Displayed with Three Decimal Places (xx.xxx)	0	*1
11-03-06	Reserved		Reserved	
11-07	Counter display	0 : Disable data Display 1 : Enable data Display	0	

12-User parameter group

Function Code No.	Description	Range/Code	Factory Setting	Remarks
12-00	Drive Horsepower Code		----	*3
12-01	Software Version	----	----	*3
12-02	Fault Log (Last 3 Faults)		----	*3
12-03	Accumulated Operation Time1 (Hours)	0~23	----	*3
12-04	Accumulated Operation Time2 (Days)	0~65535	----	*3
12-05	Accumulated Operation Time Mode	0 : Time Under Power 1 : Run Mode Time Only	0	*3
12-06	Reset Drive to Factory Settings	1150 : Reset to the 50Hz factory setting 1160 : Reset to the 60Hz factory setting	----	
12-07	Parameter Lock	0 : Enable all Functions 1 : 03-01~03-08 cannot be changed 2 : All Functions cannot be changed Except 03-01~ 03-08 3 : Disable All Function	0	
12-08	Parameter password	00000~65535	00000	

13-Auto Run function group

Function Code No.	Description	Range/Code	Factory Setting	Remarks
13-00	Auto Run(sequencer) mode selection	0 : Disabled. 1 : Single cycle. (Continues to run from the unfinished step if restarted). 2 : Periodic cycle. (Continues to run from the unfinished step if restarted). 3 : Single cycle, then holds the speed Of final step to run.(Continues to run from the unfinished step if restarted). 4 : Single cycle. (starts a new cycle if restarted). 5 : Periodic cycle. (starts a new cycle if restarted). 6 : Single cycle, then hold the speed of final step to run. (starts a new cycle if restarted).	0	
13-01	Auto _ Run Mode Frequency Command 1	0.00 ~ 400.00 (Hz)	0.00	
13-02	Auto _ Run Mode Frequency Command 2			
13-03	Auto _ Run Mode Frequency Command 3			
13-04	Auto _ Run Mode Frequency Command 4			
13-05	Auto _ Run Mode Frequency Command 5			
13-06	Auto _ Run Mode Frequency Command 6			

Function Code No.	Description	Range/Code	Factory Setting	Remarks
13-07	Auto_Run Mode Frequency Command 7			
13-08~ 13-15	Reserved		Reserved	
13-16	Auto_Run Mode Running Time Setting 0	0.0 ~ 3600.0 (second)	0.0	
13-17	Auto_Run Mode Running Time Setting 1			
13-18	Auto_Run Mode Running Time Setting 2			
13-19	Auto_Run Mode Running Time Setting 3			
13-20	Auto_Run Mode Running Time Setting 4			
13-21	Auto_Run Mode Running Time Setting 5			
13-22	Auto_Run Mode Running Time Setting 6			
13-23	Auto_Run Mode Running Time Setting 7			
13-23~ 13-31	Reserved		Reserved	
13-32	Auto_Run Mode Running Direction 0	0: stop 1: forward 2: reverse	0	
13-33	Auto_Run Mode Running Direction 1			
13-34	Auto_Run Mode Running Direction 2			
13-35	Auto_Run Mode Running Direction 3			
13-36	Auto_Run Mode Running Direction 4			
13-37	Auto_Run Mode Running Direction 5			
13-38	Auto_Run Mode Running Direction 6			
13-39	Auto_Run Mode Running Direction 7			

※Notes : *1 Can be modified during run

*2 cannot be modified while communication is active

*3 do not change while making factory setting

*4 the parameter will be changed by replacing model

*5 only available in V/F mode

4.4 Parameter Function Description

Group0- The basic parameters group

00-00 : Control Mode 0 : V/F mode 1 : Vector mode (General Purpose)

To select the appropriate vector control mode or V/F mode according to the load characteristics.

1. If V/F mode is selected, please set parameters, group5 to comply with the load features.

Vector is best suited to control the general load or rapidly-changed torque load.

00-01 : Volts/Hz Patterns (V/F) = 0 ~ 18

1.00-01= 0 ~17, V / F Pattern. (Refer to group5)

2.00-01=18 , Flexible V/F pattern, programmable according to parameters 05-04 ~ 05-09.

00-02 : Motor rotation = 0 : forward 1 : reverse

Note: when 10-01 is set to 1, 00-02 is not set to 1

00-03 : Main Run Command Source Select

=0 : Keypad =1 : External Run/Stop Control

=2 : Communication

00-04 : Alternative Run Command Source Select

=0 : Keypad =1 : External Run/Stop Control

=2 : Communication

1. 00-03/00-04=0, the inverter is controlled by the keypad.

2. 00-03/00-04=1, the inverter is controlled by the external terminals, and the Stop key for emergency stop is operational. (Refer to 04-02 description)

※Note: 00-03/00-04=1, please refer to parameter 04-03 , 04-04 , 04-06 , 04-07 for detailed description in order to ensure safety of operators and machines.

3. 00-03/00-04=2, the inverter is controlled by Communication.

4. When 01-00 ~ 01-05 is set 10 (Main/Alt Control Signal Select) ,if the terminal is ON, the inverter is controlled by parameter 00-03,if the terminal is Off, the inverter is controlled by parameter 00-04.

00-05 : Main Frequency Command Source Select

=0 : UP/DOWN of Keypad

=1 : Potentiometer on Keypad

=2 : External AVI Analog Signal Input

=3 : External Up/Down Frequency Control

=4 : Communication setting Frequency

00-06 : Alternative Frequency Command Source Select

=0 : UP/DOWN of Keypad

=1 : Potentiometer on Keypad

=2 : External AVI Analog Signal Input

=3 : External Up/Down Frequency Control

=4 : Communication setting Frequency

1. Please refer to description of parameter group 01-00 ~ 01-05 (multifunction input terminals) for the function Up/Down terminal.

2. The priority in reading frequency is Jog> preset speed> ▲ ▼ on keypad or Up / Down or communication control.

3. When 01-00 ~ 01-05 is set 14 (Main/Alt Frequency Command Select) ,if the terminal is ON, the inverter frequency command is set by parameter 00-05,if the terminal is Off, the inverter frequency command is set by parameter 00-06.

00-07 : Frequency Upper limit(Hz) 0.01 ~ 400.00

00-08 : Frequency Lower limit(Hz) 0.01 ~ 399.99

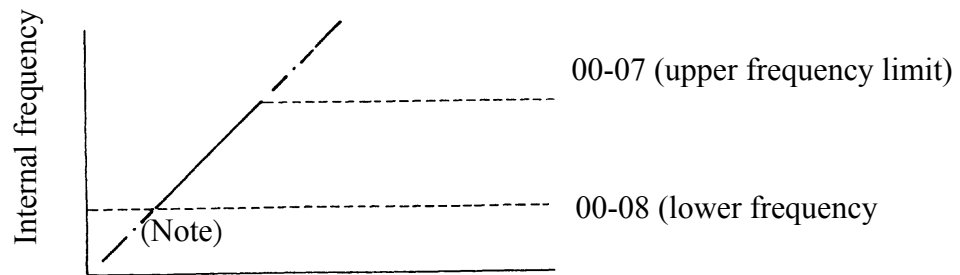

Figure 4-4 Frequency reference limits

※Note: When 00-08 = 0 Hz and frequency command is 0 Hz; the inverter will stop at 0 speed.
When 00-08 > 0 Hz and frequency command ≤ 00-08, the inverter will output the 00-08 preset value.

00-09 : Acceleration time 1 (s) = 0.1 ~ 3600.0

00-10 : Deceleration time 1 (s) = 0.1 ~ 3600.0

1. Formula for calculating acceleration and deceleration time : The denominator is base on the rated frequency of motor.

$$\text{acceleration time} = \frac{00-09(\text{ or } 10-05) \times \text{preset frequency}}{06-04}$$

$$\text{deceleration time} = \frac{00-10(\text{ or } 10-06) \times \text{preset frequency}}{06-04}$$

2. When 01-00 ~ 01-05 is set 07 (the second acceleration and deceleration time) , the first acceleration/ deceleration or the second acceleration/ deceleration/ will be set by OFF or ON the external input terminal.

3. When 01-00 ~ 01-05 is set 05/06 (Jog) , Jog run is controlled by external terminals.

The acceleration and deceleration action will be at Jog acceleration and deceleration time.

The list setting :

Function	Acc/ Dec time 1 (00-09/0-10)	Acc/ Dec time 2 (10-05/10-06)	JOG Acc/Dec time (00-13/00-14)
preset value	00-05/00-06 determines the output frequency	00-05/00-06 determines the output frequency	Run at 00-12 Jog frequency
01-00 ~ 01-05=05/06 Jog command	Off	Off	On
01-00 ~ 01-05=07 Toggle Acc/Dec time	Off	On	Off

2. 10-01=1, the reverse command is unavailable

00-11 : Operation modes for external terminals

0 : Forward/stop-reverse/stop

1 : Run/stop-forward/reverse

2 : 3-wire control mode -run/stop

- 1.) When operation command 00-03/00-04 = 0 (external terminal), 00-11 is valid.
- 2.) When operation command 00-03/00-04 = 1 (external terminal control), the stop button for emergency is available. (Refer to 04-02 for detail description).
- 3.) That both forward and reverse commands are ON will be treated as STOP.

1. 00-11 = 0, Control mode is as below:

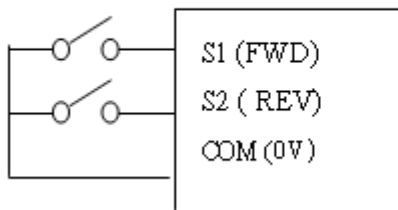

2. 00-11 = 1, Control mode is as below:

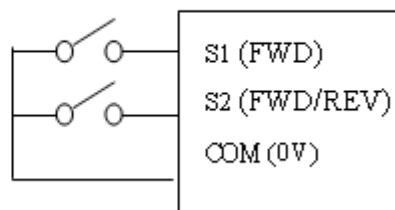

Figure 4-5 Terminal Board Drive Operation Modes

3. 00-11 = 2, Control mode is as below:

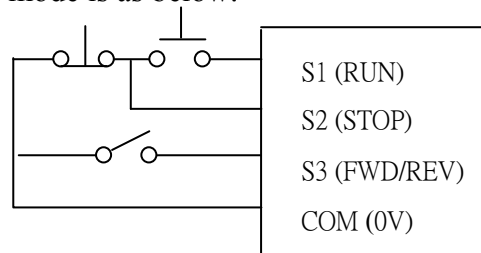

Figure 4-6 3-Wire start/stop wiring

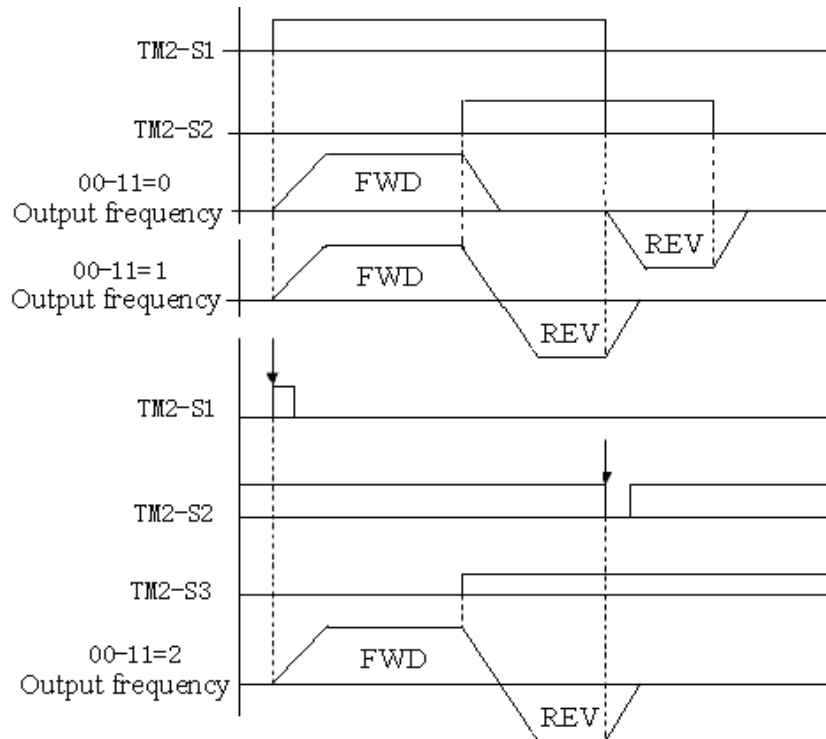

Figure 4-7 Drive start/stop operation sequences

※Note: 1.As 3 wire control mode is selected, the terminal S1, S2 and S3 is not controlled by 01-00, 01-01 and 01-02.

- | | | |
|----------------|---|----------------------|
| 00-12 : | Jog Frequency (Hz) | =1.00 ~ 25.00 |
| 00-13 : | Jog Acceleration Time (MFIT) (S) | =0.1 ~ 25.5 |
| 00-14 : | Jog Deceleration Time (MFIT) (S) | =0.1 ~ 25.5 |

Example : When 1-00(S1)=5 , 1-01(S2)=6 (Jog), Jog run is controlled by external terminals, S1 on is Jog-forward, S2 on is Jog-reverse.

Group1- External terminal digital signal input function group

Multifunction input terminals (TM2 S1 ~ S6) controlling :

- | | |
|------------------|--|
| 01-00~05: | 0 : Forward/Stop Command |
| | 1 : Reverse/Stop Command |
| | 2 : Preset Speed unit 0 (3-02) |
| | 3 : Preset Speed unit 1 (3-03) |
| | 4 : Preset Speed unit 2 (3-05) |
| | 5 : JOG Forward Command |
| | 6 : JOG Reverse Command |
| | 7 : Acc/Dec time 2 |
| | 8 : Emergency Stop |
| | 9 : Base Block |
| | 10 : Main/sub Control Signal Select |
| | 11 : Acc/Dec Disabled |

- 12 : Up Command**
- 13 : Down Command**
- 14 : Main/sub Control Signal Select**
- 15 : PID Function Disabled**
- 16 : Integration Value Resets to Zero**
- 17 : Reset**
- 18 : KEB function**
- 19 : Auto _ Run Mode**
- 20 : Counter Trigger Signal**
- 21 : Counter Reset**

A. The terminals S1- S6 on terminal block (TM2) are multifunction input terminals. The 22 functions shown above can be set for these terminals.

B. Function Description for 1-00~05 :

1. 01-00~05=0/1(Forward/Reverse/Stop)

As forward command is ON, the inverter runs and stops when the command is OFF. The 1-00 factory setting is forward.

As reverse command is ON, the inverter runs and stops when the command is OFF. The 1-01 factory setting is reverse.

2. 01-00~05=2/3/4 (Frequency Command 1/2/4 at 3-02/3-03/3-05)

When External multifunction input terminals are ON, the inverter is operates at the preset speed and the duration is determined by the time the input is ON. The corresponding preset frequency will be according to preset value of parameters 3-01 to 3-07 and in relation to the operation of input terminals 1 to 3. as shown in the table below:

Output frequency preset value	Multifunction terminal 3 Preset value =4	Multifunction terminal 2 Preset value =3	Multifunction terminal 1 Preset value =2
3-01	0	0	0
3-02	0	0	1
3-03	0	1	0
3-04	0	1	1
3-05	1	0	0
3-06	1	0	1
3-07	1	1	0
3-08	1	1	1

3. 01-00~05=5/6(Forward/ Reverse JOG)

When Jog operation, is selected, the inverter operates at the Jog acceleration and deceleration times. The corresponding jog frequency parameter is shown below:

The priority order of frequency : Jog Speed→Preset Speed→Keypad frequency or external frequency signal

4. 01-00~05=7 (Acc/Dec time selection)

This input selects the acceleration 1/ deceleration 1 or acceleration 2/ deceleration 2.

5. 01-00~05=8 : External Emergency Stop.

The inverter will decelerate to stop by 10-06 setting and Flash E.S as the emergency stop signal is received regardless of 04-01 setting. After the emergency stop signal is removed, turn the RUN switch OFF and then ON again, or press the run key in keypad mode, the inverter will restart again up and ramps up to the command frequency.

If the emergency signal is released before the inverter stops completely, the inverter still carries out the emergency stop. The 01-09/01-10 determines the action of the error terminal. If 01-09/01-10=0: the fault is not enabled when the external emergency signal input. If 01-09/01-10=8, the fault is actuated when the emergency signal input.

6. 01-00~05=9 : Base Block

The inverter immediately stops output, and the motor does a Coast with flashing B.B.

8. 01-00~05=10 : Main/sub Control Signal Selection

When External multifunction input terminals are off, the inverter is operated by 00-03.

When External multifunction input terminals are on, the inverter is operated by 00-04.

9. 1-00~05=11 : Disable acceleration and deceleration

The acceleration and deceleration action is unavailable until the disable signals are released.

The action is illustrated in the graph below:

Note : Operation Switch is OFF, the command of disable

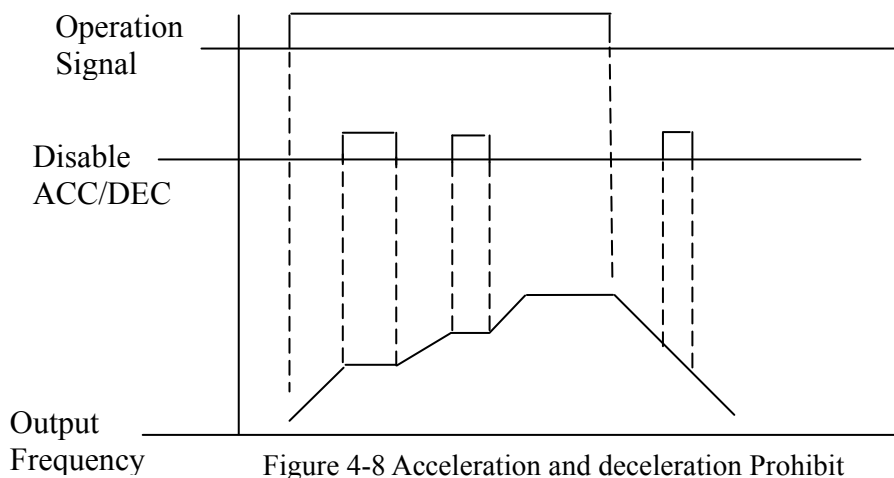

Figure 4-8 Acceleration and deceleration Prohibit

10. 1-00~05=12, 13: UP/DOWN Function (Actual ACC/DEC time is based on the setting) :

- (1) 00-05/00-06 = 3 to use the UP/DOWN Function. The other frequency signals are ignored.
- (2) Set 01-07=0 and 01-08=0. The inverter accelerates to the preset value of 03-01 when in RUN, and then it maintains a constant speed. As the inverter receives either the UP/DOWN command, it will accelerate / decelerate until the command is released. The inverter runs at the speed setting at the time of release. The inverter will ramp stop or Free-Run stop which is determined by the 04-01 as long as the inverter receives the STOP command. The frequency at Stop time will be stored in 03-01. The UP/DOWN KEY is invalid when the inverter is stopped. It is necessary to use the Keypad to modify the preset parameters.
- (3) Set 01-08 = 1, the inverter will operate from 0Hz when the operation terminal is ON. The action of UP/DOWN is the same as above. The inverter will ramp stop or free-run stop as determined by 04-01 setting when it receives the Stop Command. The next operation will start at 0 Hz.
- (4) UP/Down Signals simultaneously pressed are invalid
- (5) 01-07≠ 0, the inverter accelerates to the setting of 03-01 and maintains speed. When the UP/Down terminal is on, setting frequency is the value 03-01±01-07, and the inverter will accelerate/ decelerate to frequency 03-01. The upper frequency limit and lower frequency limit also restrict the operation. If the signal of UP/ DOWN is maintained over 2 seconds, the inverter will begin to accelerate/ decelerate. If 01-07=0, the operation is the same, until the UP/ DOWN signal is released. Please refer to the time diagram of 01-07.

11. 1-00~05=14 Main/sub Frequency Command Selection

When External multifunction input terminals are off, the inverter Frequency Command is operated by 00-05.

When External multifunction input terminals are on, the inverter Frequency Command is operated by 00-06.

12. 01-00~05=15(PID Function Disable)

When the PID Function Disable is ON, PID is not controlled by 09-00.

13. 01-00~05=16 (Integration Value Resets to Zero)

When the multifunction terminal 01-00~05 is set at 16 and the input terminal is on, the Integration Value of PID Resets to Zero.

14. 01-00~05=17(Reset Command)

The Reset command is same as the Reset Key on the panel. When the command is OFF, the inverter does not respond.

15. 01-00~05=18 (Power Source Detect for KEB)

Please refer to 4-11 description.

16. 01-00~05=19(Auto _ Run Mode)

The function of auto-run is like a simple built-in PLC function, when the external terminal function is set to 19, and turns on. Autorun function will be executed according to group 13.(Please refer to group13)

17. 01-00~05=20(Counter Trigger Signal)

when the external terminal s6 is set a function of 20,after turning it on then off once the counter value increase 1.

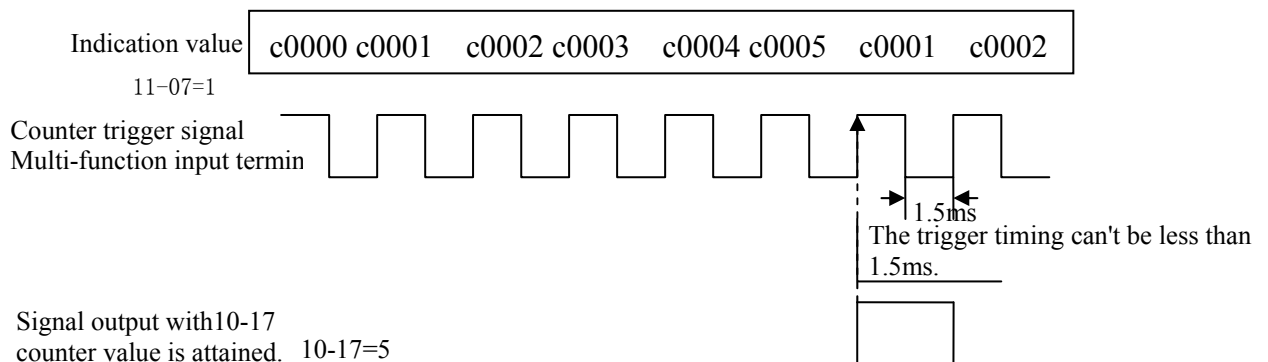

In vector mode, the external terminal S6 function of "counter trigger signal input" is disabled.

18. 01-00~05=21(Counter Reset)

When anyone of the external terminals S1~S6 is set a function of 21 and turned on, the counter value will be cleared, and display "c0000", only after this signal turns off, the inverter can receive trigger signal and count up.

Digital /Analog input signal scan times :

01-06: Multifunction terminal S1 ~ S6 confirm the scan times (x 4ms),1~200 times

1. TM2 terminal is used for scanning. If there are the same signals continuously input for N times, the inverter will treat the signal as normal. During the signal evaluation, if the scan times are less than N, the signal will be treated as noise.
2. Each scan period is 4ms.
3. The user can specify the scan times interval duration according to the noise environment. If the noise is serious, increase the value of 01-06, however the response will be slower.

Step of Up/Down Function (Hz):

01-07: Up/Down (Hz) 0.00 ~ 5.00

There are two modes covered below:

1. 01-07 = 0.00, the operation is just as the original one. When the UP terminal is ON, the frequency increases while the DOWN terminal is ON, the frequency decreases. (Refer to the following graph).

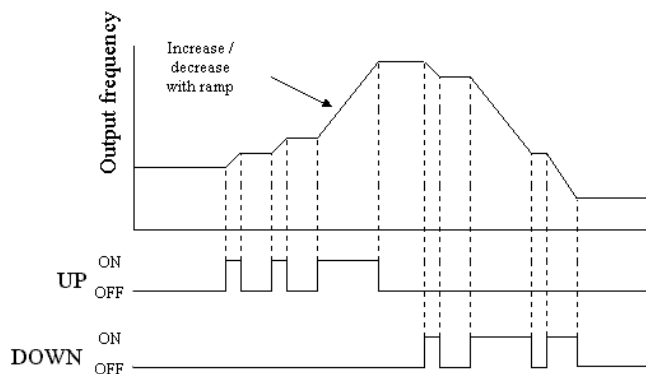

Figure 4-9 UP/DOWN original mode example

2. 01-07 = 0.01 to 5.00, and UP/ DOWN terminal ON, is equivalent to a step increase/ decrease at the increment frequency in 01-07. If UP/DOWN is pressed over 2 seconds, the original UP/DOWN mode is restored (Please refer to the following diagram)

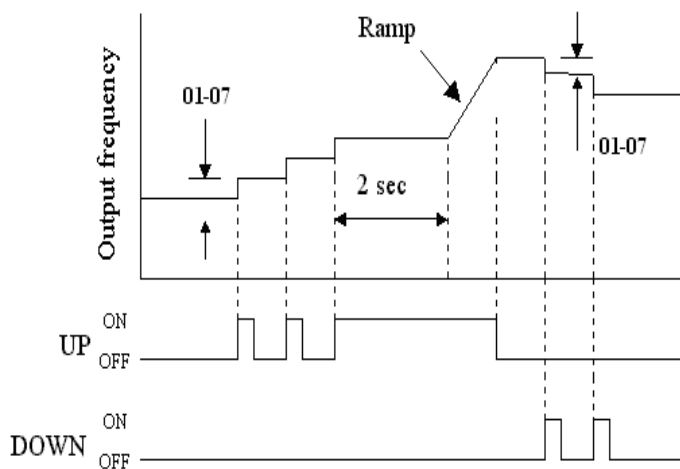

Figure 4-10 UP/DOWN with incremental steps

Stop Mode Using Up/Down:

01-08 : Up/Down keep Frequency mode

0 : When Up/Down is used, the preset frequency is held as the inverter stops, and the UP/Down function is disabled.

1 : When Up/Down is used, the preset frequency is reset to 0 Hz as the inverter stops.

2 : When Up/Down is used, the preset frequency is held as the inverter stops, and the UP/Down is available.

1. 01-08=0 : the inverter will accelerate to the speed set in parameter 03- 01 as receiving the Run command and run at such certain speed. The inverter begins to accelerate (decelerate) as the UP (Down) terminal is energized. The inverter will hold the speed as the UP/DOWN command released. When the Run Signal releases, the inverter will ramp stop or stop which determined by the 04-01. It will store the frequency when the run signal is removed. UP/DOWN keys are idle

when the inverter is stopped. The keypad is available to modify the preset frequency (03-01). If 1-08=2, the UP/Down is available as the inverter stops.

- 01-08=1 : as the Run terminal is energized, the inverter operates from 0 Hz, the Function of UP/DOWN is same as the above description. When the Run signal is released, the inverter will ramp stop or stop output (determined by 04-01) to 0 Hz. The next run command will always begin from 0 Hz.

Multifunction output terminals control :

01-09 : Output Relay RY1 Operation Mode (RC, RB, RA terminal)

01-10 : Output Relay TR1 Operation Mode (SYN+, SYN- terminal)

0 : Run

1 : Fault

2 : Frequency Reached

3 : Set Frequency (01-11 ±01-12)

4 : Frequency Threshold Level (> 01-11) - Frequency Reached

5 : Frequency Threshold Level (< 01-11) - Frequency Reached

6 : Auto-restart

7 : Momentary AC Power Loss

8 : Emergency Stop Mode

9 : Base Block Stop Mode

10 : Motor Overload Protection

11 : Drive Overload Protection

12 : Over-torque Threshold Level

13 : Top Count Value Attained

14 : Preliminary Counter Value Attained

01-11 : Frequency Reached Output Setting =0.00 ~ 400.00Hz

01-12 : Frequency Detection Range =0.00 ~ 30.00Hz

01-09/10= 2:

The preset frequency is reached (\pm 01-12)

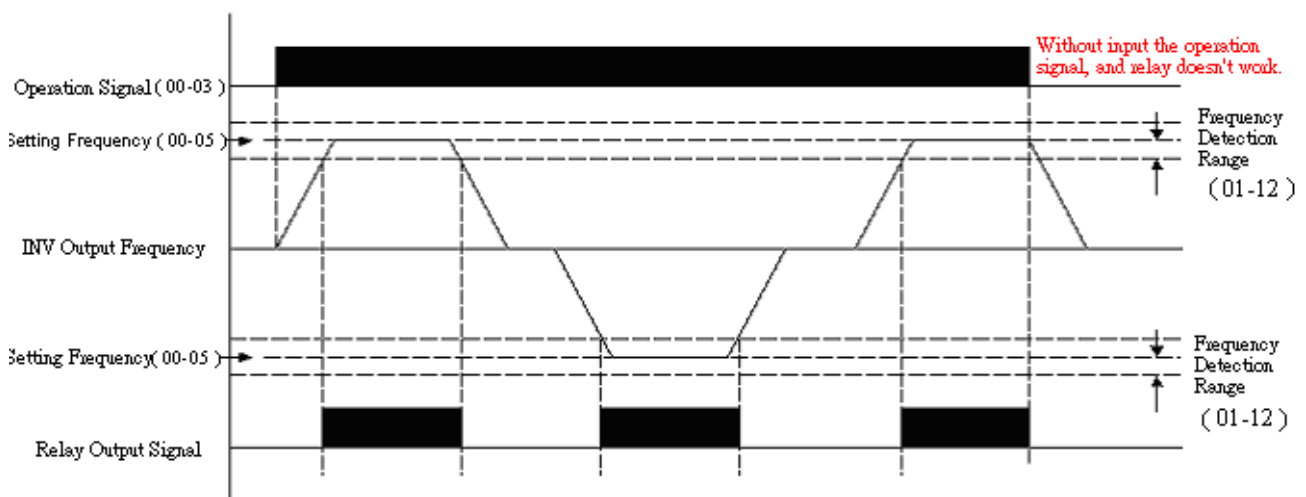

(Multifunction output terminal (01-09/01-10)=2)

Figure 4-11 Frequency reached example

01-09/10= 3:

Arbitrary frequency consistency $F_{out} = 01-11 \pm 01-12$

Operation Frequency Reached Arbitrary Frequency (01-11 \pm 01-12)

Operation conditions :

- A. | Input Frequency-Frequency Command(00-05) < Frequency Threshold Level (01-12)
- B. | Input Frequency-Detecting Level(01-11) | < Frequency Threshold Level (01-12)

Without input the operation signal or command frequency no consistency, and relay does not activate

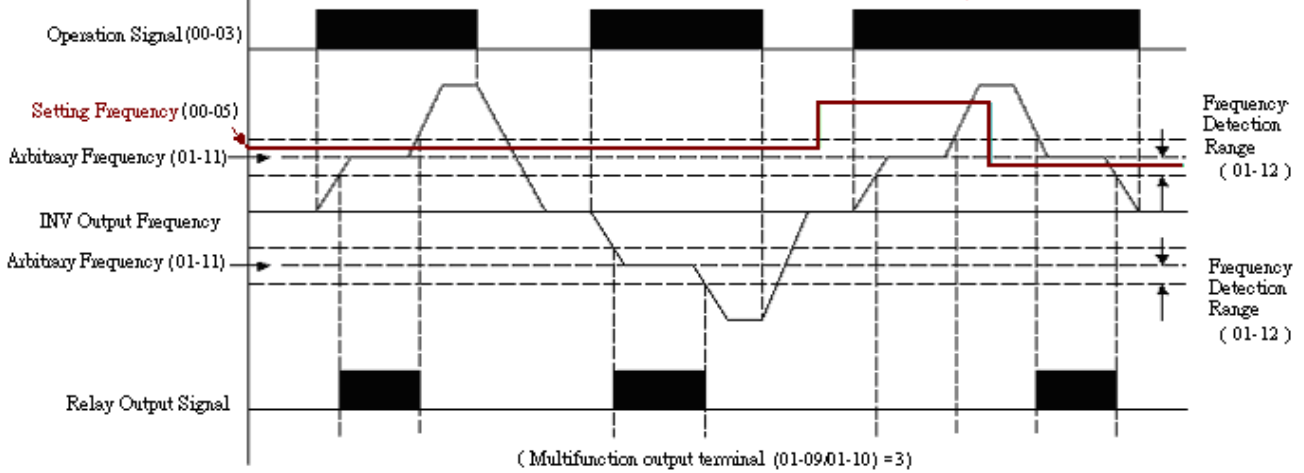

Figure 4-12 Frequency within specified range example

01-09/10= 4 : Frequency detection $F_{out} > 01-11$

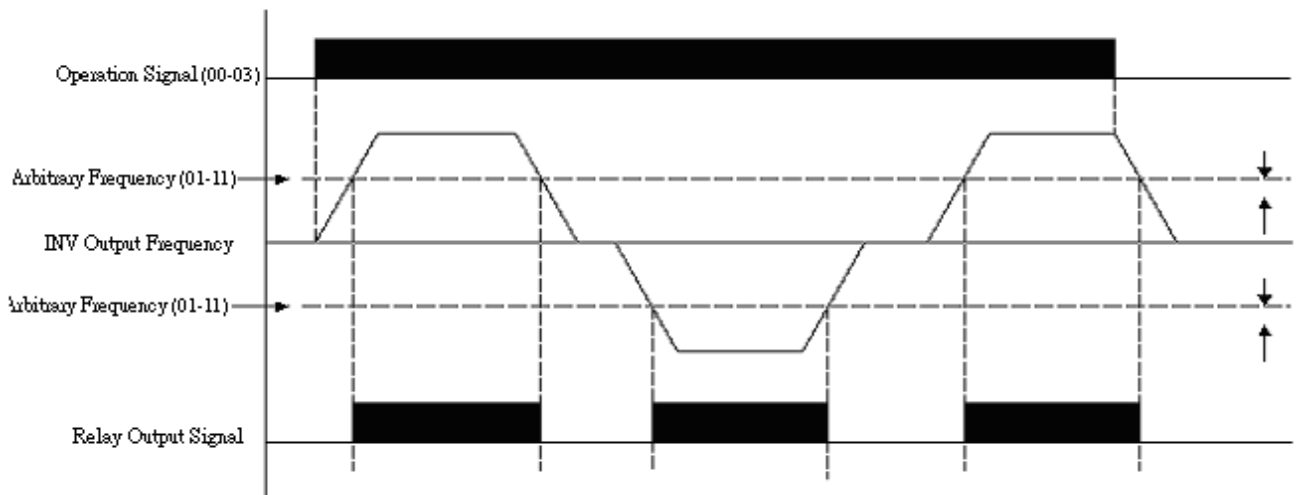

Figure 4-13 Frequency outside of range example

01-09/10= 5 : Frequency detection $F_{out} < 01-11$

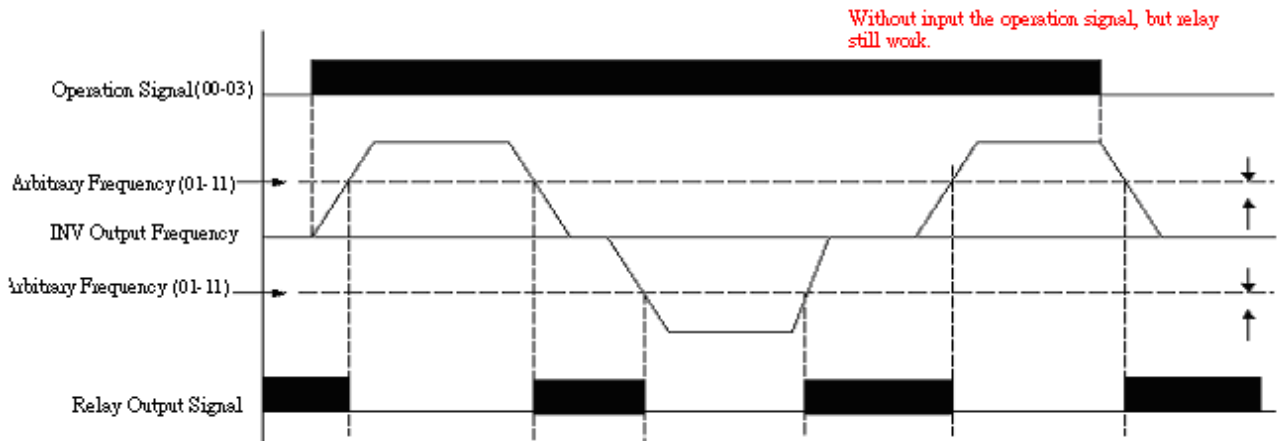

Figure 4-14 Frequency at or below specified range example

1-09/10=12 : over torque detection

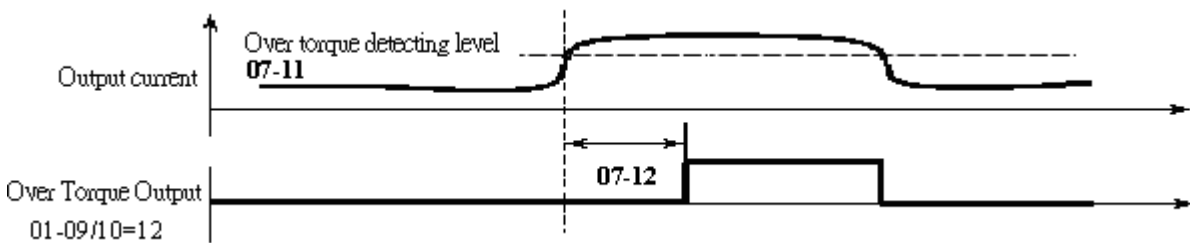

Figure 4-15 Over torque detection example

01-09/10=13

Terminal output is activated when counter reaches the Top Count Value.

01-13: S1 ~ S5 switch type select			
xxxx0	: S1	NO	xxxx1 : NC
xxx0x	: S2	NO	xxx1x : NC
xx0xx	: S3	NO	xx1xx : NC
x0xxx	: S4	NO	x1xxx : NC
0xxxx	: S5	NO	1xxxx : NC
01-14: S6 switch type select			
xxxx0	: S6	NO	
xxxx1	: S6	NC	

※Note: “NO” : Normal open, “NC” : Normal close.

The switches type is decided by 01-13/01-14,

Because of different types of switches, select switches type is necessary.

If set 01-13=0 0 0 0, means S1~S5 types of switches is Normal open, otherwise, if each bit of 01-13 is set to “1”, types of switches is Normal close.

Don't set 00-03/00-04=1, before you set 01-13, 01-14 (external terminal controlled)

Group2- External terminal analog signal input function group

02-00 : AVI/ACI analog Input signal type select

- =0 : AVI 0~10V, ACI 0~20mA
- =1 : AVI 0~10V, ACI 4~20mA
- =2 : AVI 2~10V, ACI 0~20mA
- =3 : AVI 2~10V, ACI 4~20mA

02-01 : AVI signal verification Scan Time 1~100 (×4ms)

02-02 : AVI Gain(%) 0 ~ 1000

02-03 : AVI Bias(%) 0.0 ~ 100.0

02-04 : AVI Bias Selection 0 : positive 1 : Negative

02-05 : AVI Slope 0 : positive 1 : Negative

02-06 : ACI function Select

- =0 : PID feedback signal
- =1 : ACI Bias signal input

1. 02-06=0 (PID feedback input)

When 02-06 is set 0 means the PID feedback input terminal is controlled by the setting of 09-00.

2. 02-06=1 (Bias Input)

ACI To regulate the Offset of the Keypad VR or AVI analog input, only the signal of 0~20 mA or 4~20mA .

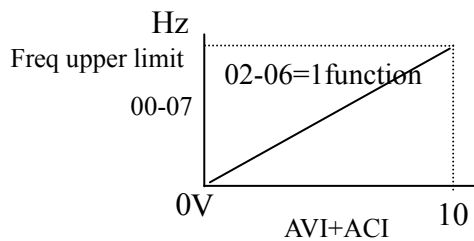

02-07 : ACI signal verification Scan Time 1~100 (× 4ms)

02-08 : ACI Gain(%) 0 ~ 1000

02-09 : ACI Bias(%) 0 .0~ 100.0

02-10 : ACI Bias Selection 0 : positive 1 : Negative

02-11 : ACI Slope 0 : positive 1 : Negative

Note : When 02-06 is set to 1, settings of 02-07~02-11 will not be effective.

Example:

The setting of figure 4-18A:

	2-02	2-03	2-04	2-05	2-09
	/2-08	/2-09	/2-10	/2-11	
A	100%	50%	0	0	100%
B	100%	0%	0	0	100%

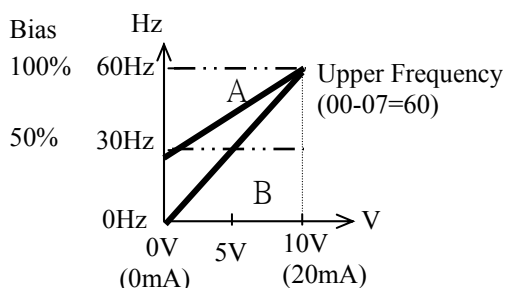

The setting of figure 4-18B:

	2-02	2-03	2-04	2-05	2-09
	/2-08	/2-09	/2-10	/2-11	
C	100%	50%	0	1	100%
D	100%	0%	0	1	100%

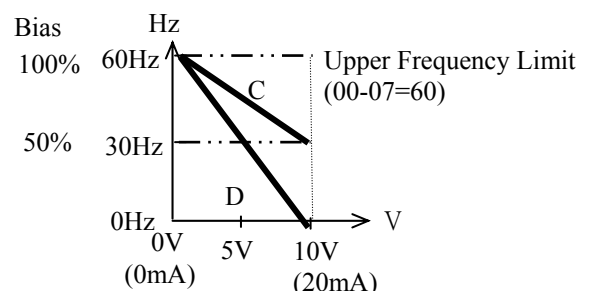

Group3- preset Frequency function group

03-00 : Preset Speed Control mode Selection =0 : common Is uniform time(Acc1/Dec1or Acc2/Dec2) =1 : Special (is single time Acc0/Dec0 ~ Acc7/Dec7)
Setting frequency 03-01~03-08 : Preset Speed 0 ~ Preset Speed 7(Hz) : =0.00 ~ 400.00
Setting time 03-17~03-32 : Preset Speed 0~7 Acceleration time(second) : =0.1 ~ 3600.0 Preset Speed 0~7 Deceleration time(second) : =0.1 ~ 3600.0

1. When 03-00 is set to 0, Acc-time (Dec-time) is determined by the 00-09/00-10(10-05/10-06).
2. When 03-00 is set to 1, Acc-time (Dec-time) is determined by the 03-01~03-08.

Function Description:

- 1) Formula for calculating acceleration and deceleration time: The denominator is base on the rated frequency of motor (06-04).

$$\text{Actual Acctime} = \frac{\text{Acctime parameter} \times \text{preset frequency}}{06-04}$$

$$\text{Actual Dectime} = \frac{\text{Dectime parameter} \times \text{pr eset frequency}}{06-04}$$

Example: 06-04=50hz (motor Rated frequency), 03-02=10hz (preset speed),
 03-19=5s (Acc time), 03-20=20s (Dec-time),

$$\text{Preset speed 1 Actual Acc time} = \frac{03-19 \times 10(\text{hz})}{06-04} = 1(\text{s})$$

$$\text{Preset speed 1 Actual Dec time} = \frac{03-20 \times 10(\text{hz})}{06-04} = 4(\text{s})$$

- 2) When 03-00 is set to 1, the time has two modes to be set:

Example: 00-03=1, 01-00=0 (S1=RUN/STOP),

01-01=1 (S2=forward/reserve),

01-02=2 (S3=preset speed1), 01-03=3 (S4= preset speed 2),

01-03=4 (S5= preset speed 4);

mode1: When the run command is uncontinuous, calculate acceleration and deceleration time of each segment like this

$$a = \frac{(03-17) \times (03-01)}{06-04}, b = \frac{(03-18) \times (03-01)}{06-04}, c = \frac{(03-19) \times (03-02)}{06-04}, d = \frac{(03-20) \times (03-02)}{06-04} \dots\dots$$

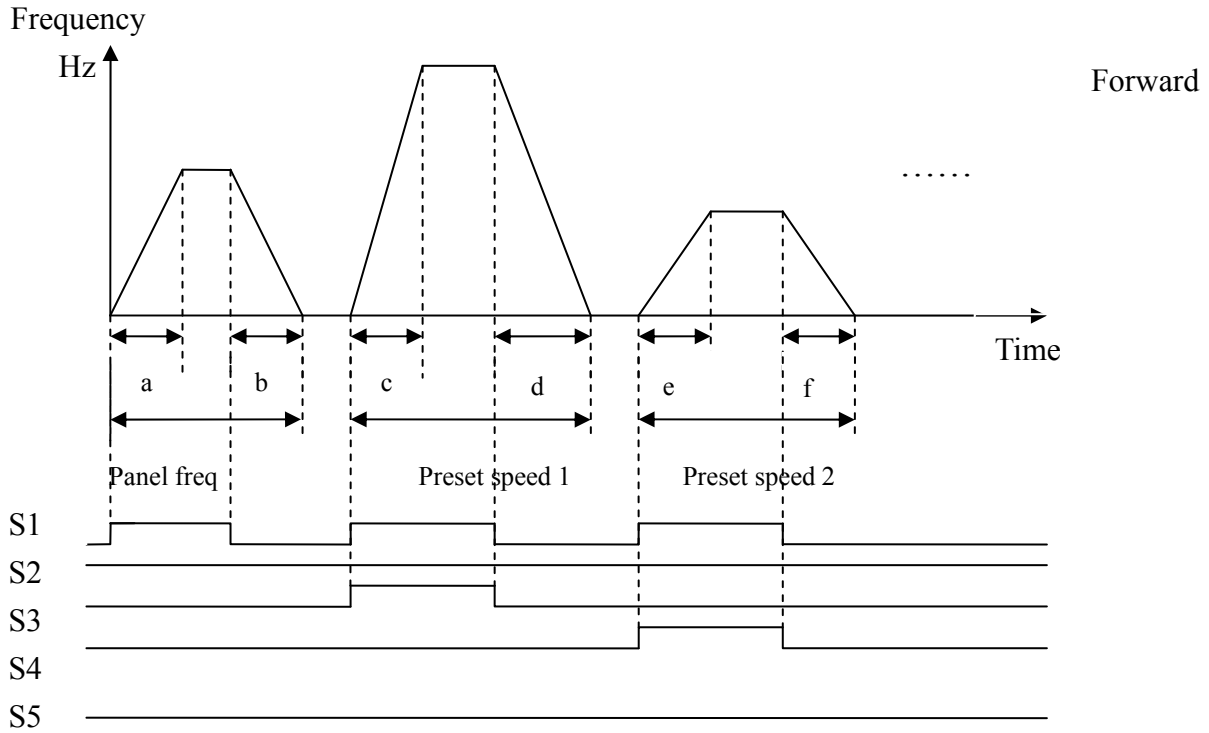

mode2: When the run command is continuous , calculate acceleration and deceleration time of each segment like this

$$a = \frac{(03-17) \times (03-01)}{06-04}, \quad b = \frac{(03-20) \times [(03-01) - (03-02)]}{06-04}, \quad c = \frac{(03-21) \times [(03-03) - (03-02)]}{06-04}$$

$$d = \frac{(03-24) \times (03-03)}{06-04}, \quad e = \frac{(03-23) \times (03-04)}{06-04}, \quad f = \frac{(03-26) \times (03-04)}{06-04}, \quad g = \frac{(03-25) \times (03-05)}{06-04},$$

$$h = \frac{(03-26) \times (03-05)}{06-04} \dots\dots$$

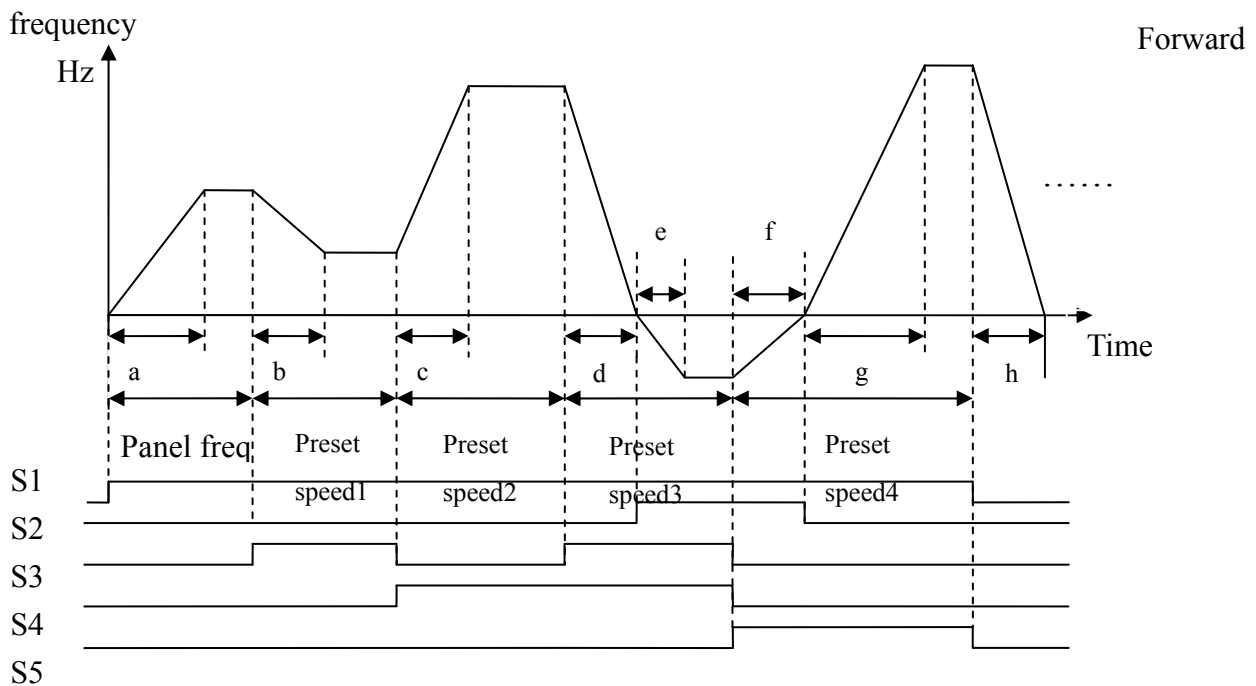

Group4- Start/Stop command group

04-00 : Starting Method Selection

=0 : Normal start

=1 : Enable Speed Search

- 1.04-00=0: On starting, the inverter accelerates from 0 to target frequency in the set time.
- 2.04-00=1: On starting, the inverter accelerates to target frequency from the detected speed of motor.

04-01 : Stopping Method Selection

=0: braking capacity

=1: Coast to stop

- 1.04-01=0 : the inverter will decelerate to 0Hz in preset deceleration time after receiving the stop command.
- 2.04-01=1: the inverter will stop output as receiving the stop command. The motor will inertia Coast to stop.

04-02 : Stop Key on keypad

=0 : Stop Button Enabled

=1 : Stop Button Disabled

- 04-02=0, The STOP key is available for controlling the inverter to stop.

04-03 : Momentary power loss and restart

=0 : Momentary Power Loss and Restart disable

=1 : Momentary power loss and restart enable

=2 : Momentary power loss and restart enable while CPU is operating.

(According to the capacity of DC power)

04-04 : Momentary Power Loss Ride-Thru Time (Seconds) : 0.0 ~ 2.0 second

- 1.If the input power supply due to sudden increase in supply demand by other equipment results in voltage drops below the under voltage level, the inverter will stop output at once. If the power supply voltage level recovers in the 04-04 preset time, it will spin start tracing from the trip frequency, or otherwise the inverter will trip with 'LV-C' fault displayed.
2. The allowable power loss time differs with the models. The range is from 1second to 2 second.
3. 04-03=0: as power lost, the inverter will not start.
4. 04-03=1: if the loss time is less than the value of 04-04, the inverter will Spin Start in 0.5 second as the power is resumed and restart times are infinite.
5. 04-03=2:the power lost for long time, before the inverter lost the control power for the CPU, the inverter will restart according to the 00-03 and 04-05 setting and status of external switch as the resumed.

Note: 00-03=1 04-05=0 04-03=1 or 2 after a power loss for a long time, please turn OFF the power and power switches to avoid any possible injury to operators and machines when the power is resumed unexpectedly.

04-05 : Auto Restart Method:

=0 : Enable Speed Search

=1 : Normal Start

1. 04-05=0: When auto-restarting the inverter will detect the rotating speed of the motor. The Motor will be controlled to accelerate from the present speed to the target speed.
2. 04-05=1: The inverter restart from 0 speed to set frequency in acceleration time when auto-restart.

04-06 : Auto Restart Delay Time (Seconds) : 0 ~ 800.0 second

04-07 : Number of Auto Restart Attempts : 0 ~ 10 times

1. 04-07=0: The inverter will not auto restart after trips due to fault.

2. 04-07>0, 04-06= 0:

The inverter will conduct SPIN START in 0.5 second after trips due to fault. The motor will Coast to stop while the output is switched off, once the rotating speed is determined then it will accelerate or decelerate from this speed to the running speed before the fault.

3. 04-07>0, 04-06>0:

The output will be stopped for a period which is determined by the 04-06 after a fault trip. Then, spin start to set target frequency.

4. Auto restart after a fault will not function while DC injection braking or decelerating to stop.

04-08 : Reset Mode Setting

0 : Enable Reset Only when Run Command is Off

1 : Enable Reset when Run Command is On or Off

04-08=0 Once the inverter is detected a fault, please turn Run switch Off and then On again to perform reset, otherwise restarting will not be possible.

04-09 : Direct Running After Power Up

0 : Enable Direct running after power up

1 : Disable Direct running after power up



Danger:

1. 04-09=0 and the inverter is set external terminal controlled (00-03/00-04=1), if the run switch is ON as power is supplied, the inverter will auto start. It is recommend that the power is turned off and the run switch is also off to avoid possibility of injury to operators and machines as the power is reapplied.

Note: IF this mode is required all safety measures must be considered including warning labels.

2. 04-09=1 and the inverter is set external terminal controlled (00-03/00-04=1), if the run switch is ON as power is supplied, the inverter will not auto start and the display will flash with STP1.

It is necessary to turn OFF the run switch and then ON to start normally.

04-10 : Delay-ON Timer (Seconds) : 1.8 ~ 300.0 second

As power on and 04-09=0, the inverter will perform auto restart in the setting time for delay.

04-11 : Kinetic Energy Back-up Deceleration Time (S)

= 0.0 : Disable

= 0.1~25.0 : KEB Deceleration Time

04-11 = 0 KEB function disable 04-11≠ 0 KEB function enables

Example : 220V system

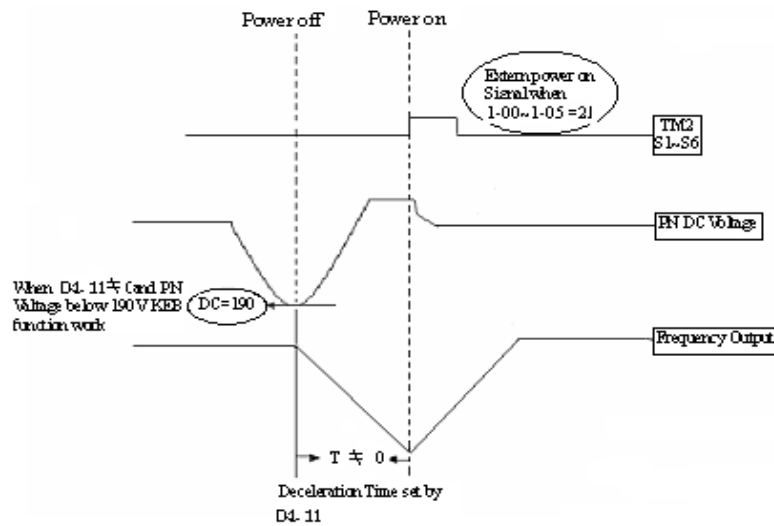

Figure 4-18 KEB function diagram

※**Note:**

1. When 04-11≠0, the momentary power loss and Restart is disabled, the inverter will do KEB Function.
2. When input power is turned off, CPU detects the DC bus Voltage and as soon as DC bus Voltage becomes lower than 190V (220V system) or 380V (440V system), then the KEB function is activated.
3. When KEB function is enabled, the inverter decelerate to zero by 04-11, and the inverter stop
4. IF the power on signal enabled during the KEB function, the inverter accelerate to original frequency.

04-12 : Lower Limit of Power Voltage Detect = 150.0 ~ 210.0/300.0 ~ 420.0

04-13 : DC Injection Brake Level(%) @start = 0.0 ~ 150.0

04-14 : DC Injection Brake Time (Seconds) @start = 0.0 ~ 25.5

04-15 : DC Injection Brake Start Frequency (Hz) @Stopped = 0.10 ~ 10.00

04-16 : DC Injection Brake Level (%)@Stopped = 0.0 ~ 150.0

04-17 : DC Injection Brake Time (Seconds)@stopped = 0.0 ~ 25.5

1. 04-17 / 04-15 is the action time and start frequency of DC braking, as graph below:

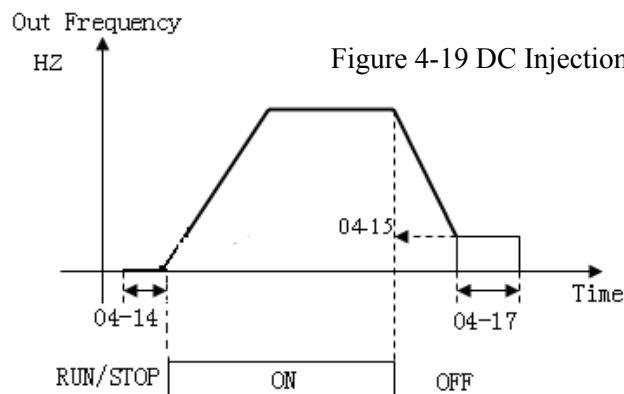

Figure 4-19 DC Injection Braking Example

Group5- V/F command group

V/F PATTERN Selection

- 05-00 : Volts/Hz Curve Modification (Torque Boost) (%) = 0 ~ 30.0**
- 05-01 : Motor no load current(Amps AC) -----**
- 05-02 : Motor rated Slip Compensation (%) = 0.0 ~ 100.0**
- 05-03 : v/f Maximum voltage (Vac)**
- 05-04 : Maximum Frequency (Hz) = 0.20 ~ 400.0Hz**
- 05-05 : Maximum Frequency Voltage Ratio (%) = 0.0 ~100.0**
- 05-06 : Medium Frequency2 (Hz) = 0.10 ~400.0Hz**
- 05-07 : Medium Frequency Voltage Ratio2(%) = 0.0 ~100.0**
- 05-08 : Medium Frequency1 (Hz) = 0.10 ~400.0Hz**
- 05-09 : Medium Frequency Voltage Ratio1 (%) = 0.0 ~100.0**
- 05-10 : Minimum Frequency (Hz) = 0.10 ~400.0Hz**
- 05-11 : Minimum Frequency Voltage Ratio (%) = 0.0 ~100.0**
- 05-12 : V/F start Frequency = 0.00~ 10.00**

1.00-01=18, set the V/F pattern freely complying with 05-04 ~ 05-09 (Refer to following diagram)

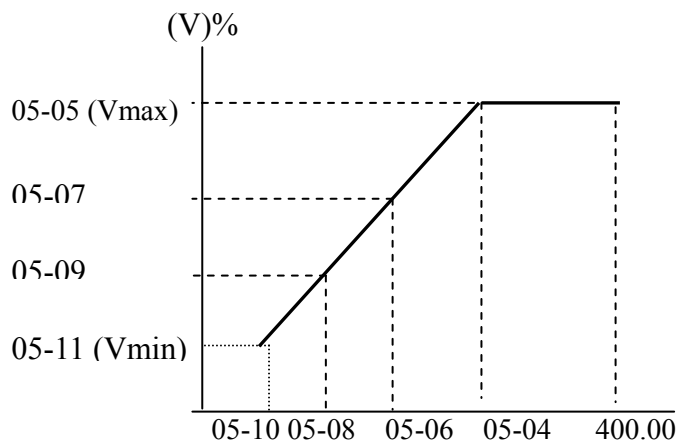
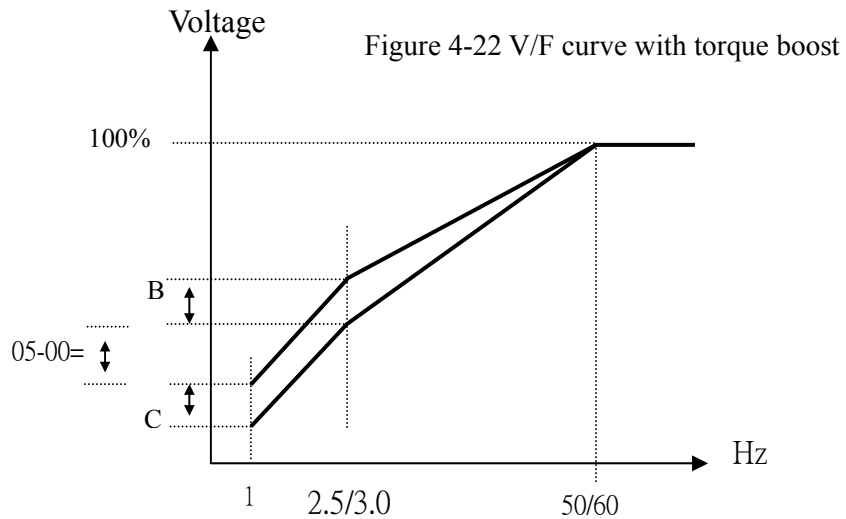

Figure 4-20 Custom V/F Settings

00-01	B	C
0 / 9	7.5%	4.5%
1 / 10	10.0%	7.0%
2	11.0%	8.5%
3	12.0%	9.5%
4	17.5%	4.0%
5	25.0%	5.0%
11	11.0%	8.0%
12	12.0%	9.0%
13	20.5%	7.0%
14	28.5%	8.0%
6 / 15	45.0%	1.0%
7 / 16	55.0%	1.0%
8 / 17	65.0%	1.0%

3. The inverter will output the value of B, C voltage (refer to 00-01) plus the 05-00 V/F pattern setting. The starting torque will be raised as shown.



※Note: 05-00=0, Torque boost function is invalid

4. When the induction motor is in running, there must be slip due to the load. It is necessary to boost voltage to improve the precision of the speed.

$$\text{Slip frequency boost} = \frac{\text{Output Current}-(05-01)}{(06-01)-(05-01)} \times (05-02)$$

Note : 06-01=motor rated current
05-01=motor no load current

05-02 approximate value=
$$\frac{(\text{Motor synchronization speed}- \text{Rated speed})}{\text{Motor synchronization speed}}$$

↑
Marked on the motor nameplate

$$\text{Motor synchronization speed (RPM)} = \frac{120}{\text{Motor Poles}} \times \text{Motor rated frequency (50Hz or 60Hz)}$$

Example: 4 Poles, 60Hz induction motor synchronization speed = $\frac{120}{4} \times 60 = 1800$ RPM

※ Note: Motor no load current (05-01) differs with the inverter capacities (12-00) (Refer to 06-01 note). It should be regulated according to actual conditions.

Group6- Motor parameter group

- 06-00 : Motor Rated Voltage (VAC)**
- 06-01 : Motor Rated Current (Amp AC)**
- 06-02 : Motor Rated Power (kW)**
- 06-03 : Motor Rated Speed (RPM)**
- 06-04 : Motor Rated Frequency (Hz)**

06-06 : Torque boost gain (Vector)

Performance: If the motor load is determined to be too large increase the output torque.

$$\Delta T_e \doteq (\text{load current } I) \times (\text{compensation gain Gain})$$

• Torque/Speed curve pattern :

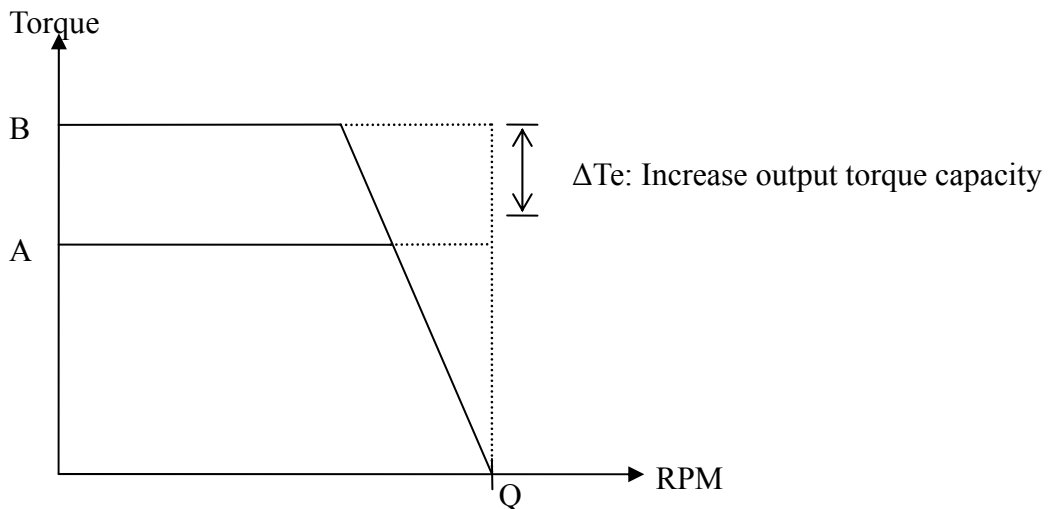

A: before torque boost

B: after torque boost

Figure 4-23 Output Torque Capacity

- Operating frequency range : 0~Motor rate frequency
- When the motor output torque is not enough and increase 06-06 setting value.
- When the motor is erratic or vibrates decrease 06-06 setting value.
- The max. Output torque limit to the inverter is current rated.
- If increase 06-06 setting value then the output current is too large. Please increase 06-07 setting value on the same time.

06-07 : Slip compensation gain (vector)

Performance : If the motor load appears too large, increase slip compensation.

$$\Delta F_{\text{slip}} \doteq I \times \text{Gain}$$

(load current) (compensation gain)

- Torque/Speed curve pattern :

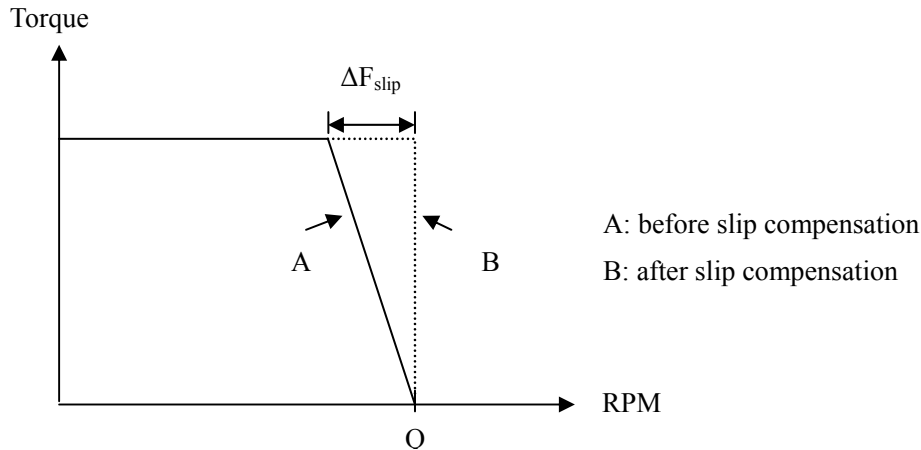

Figure 4-24 Slip Compensation

- Operating frequency range : 0~motor rated frequency.
- When the motor output rotation speed is too low increase 06-07 setting value.
- When the motor is erratic or vibrates, decrease 06-07 setting value.
- The max. output rotation speed limit to the motor max. setting frequency.
- If increase 06-07 setting value then the output current is too large. Increase 06-05 setting value at the same time.

06-11 : Low frequency voltage compensation

Performance : During low frequency

Increase 06-11 setting value to increase output voltage and low frequency torque.

Decrease 06-11 setting value to decrease output voltage and low frequency torque.

- Output voltage/frequency curve pattern :

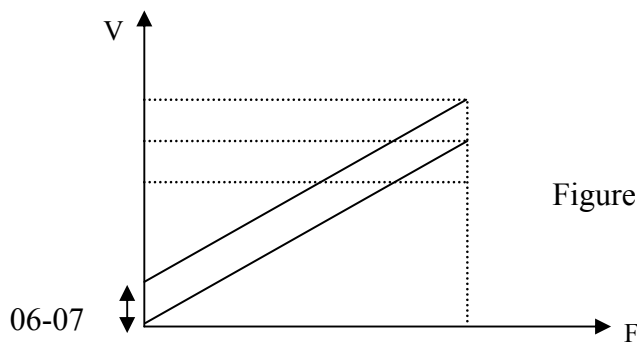

Figure 4-25 Low Frequency Voltage Compensation

- Operating frequency range : 0~12HZ / 60HZ 0~10HZ / 50HZ
- During low frequency use :
 - When the motor output torque is insufficient, increase 06-07 setting value.
 - When the motor is vibrating excessively, decrease 06-07 setting value.

Group7- Protection function group

07-00: Trip Prevention Selection

- =xxxx0 : Enable Trip Prevention During Acceleration**
- =xxxx1 : Disable Trip Prevention During Acceleration**
- =xxx0x : Enable Trip Prevention During Deceleration**
- =xxx1x : Disable Trip Prevention During Deceleration**
- =xx0xx : Enable Trip Prevention in Run Mode**
- =xx1xx : Disable Trip Prevention in Run Mode**
- =x0xxx : Enable over voltage Prevention in Run Mode**
- =x1xxx : Disable over voltage Prevention in Run Mode**

07-01 : Trip Prevention Level During Acceleration (%)	50 ~ 200
07-02 : Trip Prevention Level During Deceleration (%)	50 ~ 200
07-03 : Trip Prevention Level In Run Mode (%)	50 ~ 200
07-04 : Over voltage Prevention Level in Run Mode	350.0 VDC ~ 390.0 VDC 700.0 VDC ~ 780.0 VDC

Note:

1. In acceleration, the inverter will delay the acceleration time if the time is too short resulting in the over current in order to prevent the inverter trips.
2. In deceleration, the inverter will delay the acceleration time if the time is too short resulting in the over voltage of DC VUS in order to prevent the inverter trips with 'OV' displayed.
3. Some mechanical characteristics (such as press) or unusual breakdown (seize due to insufficient lubrication, uneven operation, impurities of processed materials, etc.) will cause the inverter to trip, thus inconvenience users. When the operating torque of the inverter exceeds the setting of 07-03, the inverter will lower the output frequency following the deceleration time, and return to the normal operation frequency after the torque get steady.

07-05: Electronic Motor Overload Protection Operation Mode :

- 0 : Enable Electronic Motor Overload Protection**
- 1 : Disable Electronic Motor Overload Protection**

07-06 : Motor type selection:

- 0 : Electronic Motor Overload Protection Set for Non-Inverter Duty Motor**
- 1 : Electronic Motor Overload Protection Set for Inverter Duty Motor**

07-07 : Motor Overload Protection Curve Selection:

- 0 : Constant Torque (OL = 103 %) (150 % for 1 Minute)**
- 1 : Variable Torque (OL = 113 %)(123 % for 1 Minute)**

07-08 : Operation After Overload Protection is Activated

- 0 : Coast-to-Stop After Overload Protection is Activated**
- 1 : Drive Will Not Trip when Overload Protection is Activated (OL1)**

Description of the thermal relay function:

1. 07-07 = 0: To protect the general mechanical load, as long as the load is less than 103% rated current, the motor continue to run. The load is larger than 150% rated current, the motor will run for 1 minute. (Refer to following curve (1)).
= 1: To protect HVAC load(FAN、 PUMP...so on): as long as the load is less than 113% rated current, the motor continue to run. The load is larger than 123% rated current, the motor will run for 1 minute.

2. The heat sinking function will not be as effective when the motor run at low speed. So the thermal relay action level will decline at the same time. (The curve 1 will change to curve 2).
3. 07-06 = 0: Set 06-04 as the rated frequency of the serve motor.
4. 07-08 = 0: the inverter coast to stop as the thermal relay acts and flash OL1. Press the 'Reset' or the external reset terminal to continue to run
= 1: the inverter continues to run as the thermal relay acts and flash OL1. Until the current decline to 103% or 113 % (determined by 9-10), OL1 will disappear.

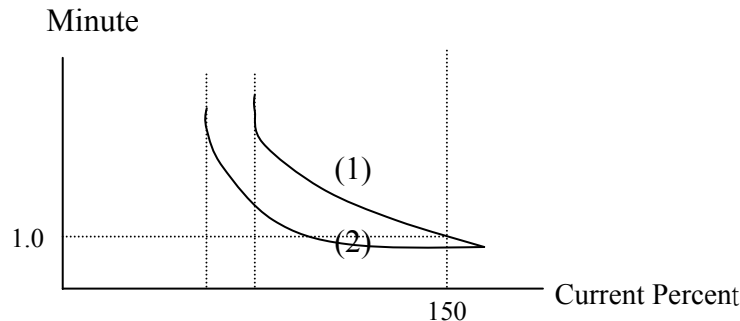

07-09 : Over torque Detection Selection(OL3)

= 0 : Disable Over torque Operation

= 1 : Enable Over torque Operation Only if at Set Frequency

= 2 : Enable Over torque Operation while the Drive is in Run Mode

07-10 : Operation After Over torque Detection is Activated

= 0 : Coast-to-Stop After Over torque is Activated

= 1 : Drive will Continue to Operate After Over torque is Activated

07-11 : Over torque Threshold Level(%) : 30~300

07-12 : Over torque Activation Delay Time (S) : 0.0~25.0

1. Over Torque is detected when the output torque level exceeds the level set in Parameter 07-11 (Inverter rated torque is 100%) and if it is detected for a duration of time which is set in parameter 07-12.
2. 07-10 = 0 : If there is over torque, the inverter coasts to stop and flashes OL3. It is necessary to press 'RESET' or external terminal to continue to run.
= 1 : If there is over torque, the inverter can continue to run and flashes OL3 until the output torque is less than the 07-11 set value.
3. Parameter 01-09/10(Multifunction output terminal) = 12, the output terminal signal will be set for over torque condition.

Note: Over torque detection will be enabled only when parameter 07-09 is set to options 1 or 2.

07-13 : OH over heat Protection (cooling fan control)

0 : Auto (Depends on temp.)

1 : Operate while in RUN mode

2 : Always Run

3 : Disabled

1. 07-13=0 : The fan runs as the inverter senses temperature rises. Thusly, extend the service period.
2. 07-13=1 : The fan runs while the inverter is running.
3. 07-13=2 : The fan is continuously running regardless of the action of the inverter.
4. 07-13=3 : The fan is **Disabled**.

Group9- PID function group

1 PID function description

The **Proportional, Integral and Derivative** control function provides closed-loop control, or regulation of a system process variable (Flow, Pressure, temperature, etc). This regulation is obtained by comparing a feedback signal with a reference (target) signal, which results in an error signal. The PID control algorithm then performs calculations on this error signal, based upon the PID parameter group9. The result of the PID algorithm is then used as the new frequency reference, or is added to the existing speed reference. The PID target value can be set by parameter 00-05/006, for example the frequency command (target) can be set from Operator keypad, AI1 Analogue input or multi function analog input terminals. Select the PID control feedback signal from external terminal AI2 for a current signal (0-20ma) or a voltage (0-10vdc), depending on setting of Jumper 3 on control board and setting of parameter 2-06.

See PID block diagram below.

※Note : PID Function is available for controlling the output flow, external fan flow and temperature.
The PID block diagram is as follows :

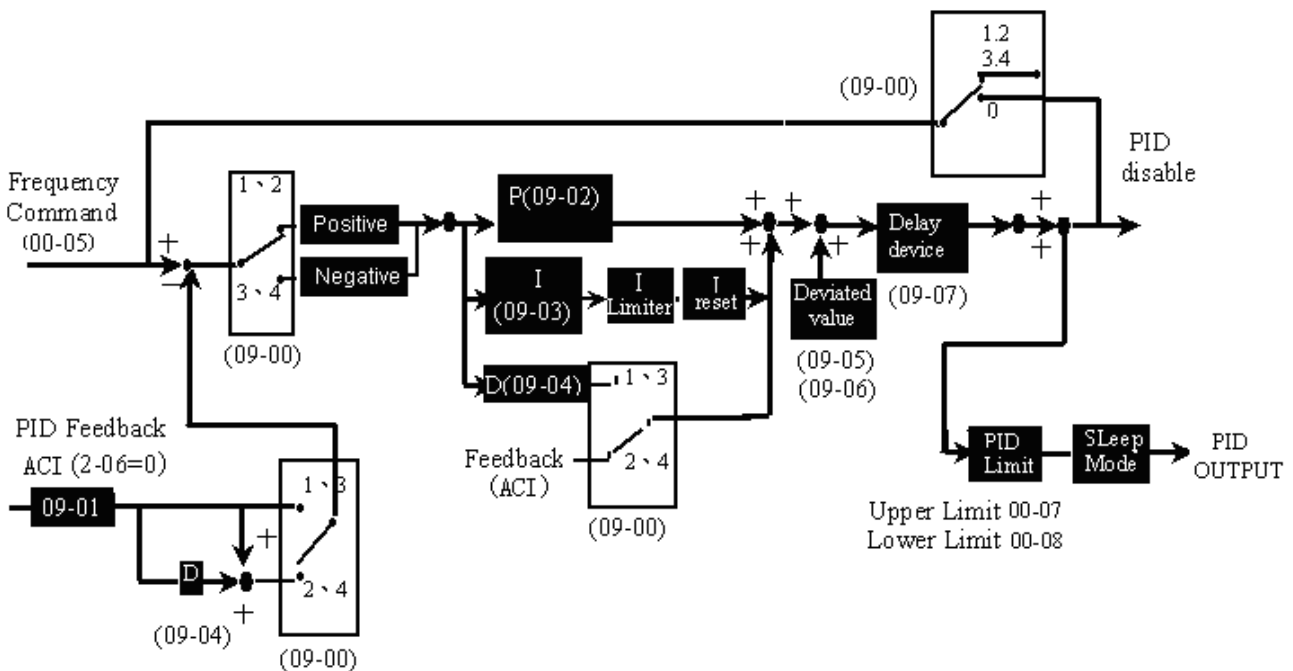

Figure 4-26 PID block diagram

1. To enable PID control, set 02-06=0, ACI on TM2 is defined as the PID feedback signal.
2. The set point in the above diagram is the 00-05/00-06 input frequency.

2 PID Group 9 parameter descriptions

09-00: PID operation selection

- =0 : disable
- =1 : enable (Deviation is D-controlled)
- =2 : Feedback D-controlled
- =3 : D Reverse characteristic controlled
- =4 : Feedback D characteristic controlled

09-00 =1, D is the deviation of (target value –detected value) in the unit time (09-04).

=2, D is the deviation of the detected values in unit time (09-04).

=3, D is the deviation of (target value – detected value) in the unit time (09-04). If the deviation is positive, the output frequency decreases, vice versa.

=4, D is the deviation of detected value in unit time (09-04). When the deviation is positive, the frequency decreases, vice versa.

09-01 : Feedback Gain coefficient (%) 0.00 ~10.00

09-01 is the calibration gain. Deviation = set point –(feedback signal×09-01)

09-02 : Proportional Gain(%) 0.00 ~ 10.00

09-02 : Proportion gain for P control.

09-03 : Integration Time(s) 0.0 ~100.0

09-03 : Integrate time for I control

09-04 : Differentiation Time(s) 0.00 ~ 10.00

09-04 : Differential time for D control

09-05: PID Offset 0 : Positive Direction 1 : Negative Direction

09-06 : PID Offset Adjust (%) 0 ~ 109

09-05/09-06: Calculated PID output is offset by 09-06 (the polarity of offset is according to 09-05).

09-07: PID Output Lag Filter Time(s) 0.0 ~ 2.5

09-07: Update time for output frequency.

09-08 : Feedback Loss Detection Mode

- 0 : Disable
- 1 : Enable – Drive Continues to Operate After Feedback Loss
- 2 : Enable – Drive “STOPS” After Feedback Loss

09-08= 0: Disable; 09-08= 1 : detect, continue running, and display ‘PDER’; 09-08= 2: detect, stop, and display ‘PDER’.

09-09 : Feedback Loss Detection Level (%) 0 ~ 100

09-09 is the level for signal loss. Error = (Set point – Feedback value). When the error is larger than the loss level setting, the feedback signal is considered lost.

09-10 : Feedback Loss Detection Delay Time (s) 0.0 ~25.5

09-10 : the minimum time to consider the feedback signal lost.

09-11 : Integration Limit Value (%) 0 ~ 109

09-11 : the Limiter to prevent the PID from saturating.

09-13 : Allowable Integration Error Margin (Unit) (1 Unit = 1/8192) =0 ~ 100

09-13=0 ~ 100% unit value : Restart the tolerance after the integrator reset to 0.

09-14 : Sleep Frequency Level (Hz) = 0.00 ~ 400.00

09-15 : Sleep Function Delay Time (S) = 0.0 ~ 25.5

09-16 : Wake up frequency Level (Hz) = 0.00 ~ 400.00

09-17 : Wake up function Delay Time (S) = 0.0 ~ 25.5

PID SLEEP MODE:

09-00=1(PID Enable)

02-06=0(PID FEEDBACK Enable)

00-05=PID setting frequency source (Target Value)

09-14 : set the sleep threshold frequency, Unit : HZ

09-15 : set the time for sleep delay, Unit : sec

09-16 : set the wake threshold frequency, Unit : HZ

09-17 : set the time for wake delay, Unit : sec

When PID output frequency is less than the sleep threshold frequency and exceeds the time of sleep delay, the inverter will decelerate to 0 and enter PID sleep mode.

When PID output frequency is larger than the Wake threshold frequency for Wake start the inverter will reactivate and enter PID wake mode. The time diagram is as follow:

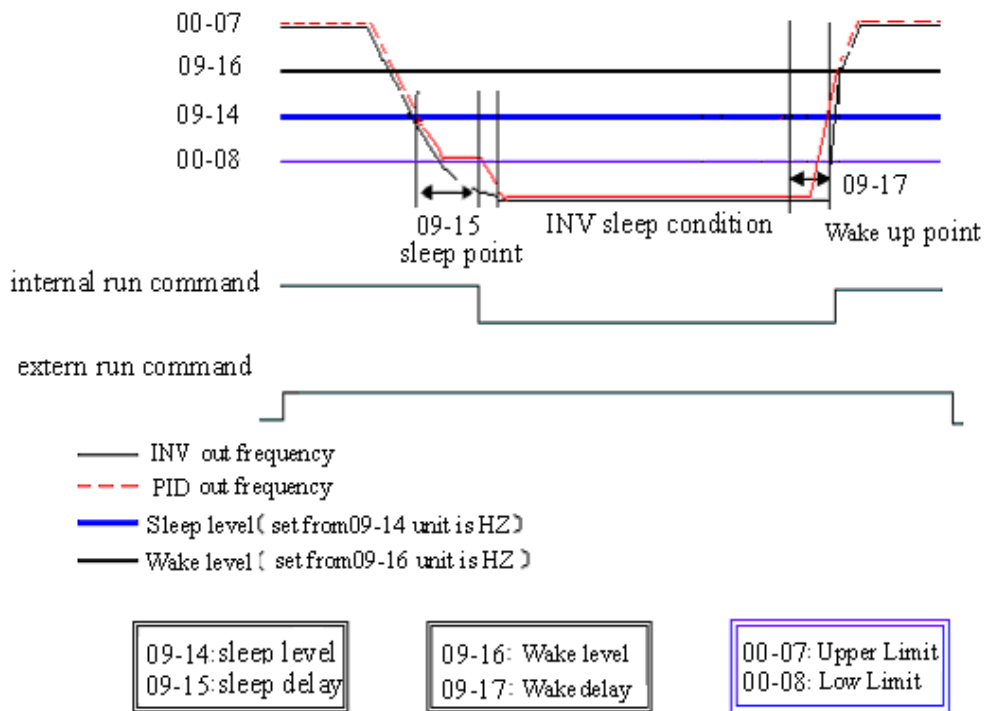

Figure 4-27 PID sleep wake mode diagram

Group10- Assistant function group

10-01: Prevention of Reverse operation

0 : Reverse command is enabled

1 : Reverse command is disabled

10-01=1, the reverse command is **disabled**.

10-02 : Keypad Operation with Up/Down Keys in Run Mode

0 : 'Enter' must be pressed after frequency change with Up/Down Keys on keypad.

1 : Frequency will be changed directly when Up/Down Keys are Pressed

10-03 : Carrier Frequency (KHz) 1-12

10-03	Carrier Frequency	10-03	Carrier Frequency	10-03	Carrier Frequency		
1	1KHz	5	5KHz	9	9KHz		
2	2KHz	6	6KHz	10	10KHz		
3	3KHz	7	7KHz	11	11KHz		
4	4KHz	8	8KHz	12	12KHz		

Note:

- In applications where there is excessive audible noise from the motor or it is required to reduce electrical interference (RFI) from the inverter caused by use of long cable then the carrier frequency can be adjusted. To reduce electromagnetic interference due to long cable etc, decrease carrier frequency. To reduce motor audible noise, increase carrier frequency.
- The carrier frequency as minimum should be set higher than ten times the max running frequency. Example : If the Max running frequency=400Hz, then set the carrier Frequency higher than 4 KHz. If the Max running frequency =300Hz, then set the carrier frequency higher than 3 KHz.
- In the vector control mode, set carrier frequency lower than 6K, to reduce noise, set random carrier frequency mode(10-04 = 2)

10-04 : Carrier mode selection

=0 : Carrier mode0 3-phase PWM modulation

=1 : Carrier mode1 2-phase PWM modulation

=2 : Carrier mode2 2-phase randomized PWM modulation

- 10-04=0 : Carrier mode0 is recommended in environments where low noise is required. Correct ambient temperature and cooling is necessary.
- 10-04=1 : Carrier mode 1 is recommended in locations where fan or pumps is required.
- 10-04=2 : Carrier mode 2 Help to slow down the temperature raise, prolong life-span of IGBT and control electromagnetism noise.

Note: When the inverter is running at high speed and high carrier frequency is selected then, please set 10-04=1 this can reduce the IGBT switching losses (heat loss).

10-05 : Acceleration Time 2 (MFIT) (s) 0.1 ~ 3600.0

10-06 : Deceleration Time 2 (MFIT) (s) 0.1 ~ 3600.0

10-07 : S-Curve Acc/Dec 1 (s) 0.0 ~ 4.0

10-08 : S-Curve Acc/Dec 2(s) 0.0 ~ 4.0

10-09 : S-Curve Acc/Dec 3 (s) 0.0 ~ 4.0

10-10 : S-Curve Acc/Dec 4 (s) 0.0 ~ 4.0

Use S Curve parameters where a smooth acceleration or deceleration action is required, this will prevent possible damage caused to machines by sudden acceleration/deceleration.

Four parameters can be selected as shown on the diagram below:

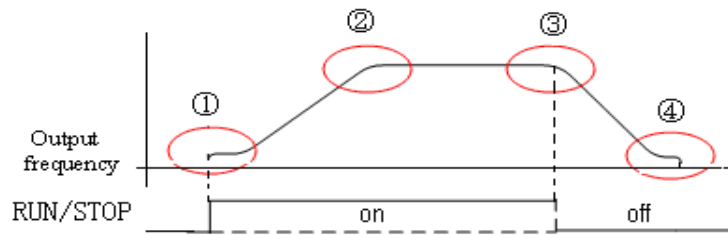

Figure 4-28 S-Curve Characteristics

Note:

- a. Regardless of the stall prevention period, actual acceleration and deceleration time = preset acceleration / deceleration time + S curve time.
- b. Please set the S curve time separately in the parameter (10-07~10-10)
- c. When S curve time (10-07~10-10) is set as 0, the S curve function is disabled.
- d. Note : The calculating of S curve time is based on the rated frequency of motor (06-04), Please refer to the parameter (00-09/00-10).

10-11 : Skip frequency 1(Hz)	= 0.00 ~ 400.00
10-12 : Skip frequency 2(Hz)	= 0.00 ~ 400.00
10-13 : Skip frequency 3(Hz)	= 0.00 ~ 400.00
10-14 : Skip frequency range (± Hz)	= 0.00 ~ 30.00

Skip frequency parameters can be used to avoid mechanical resonance in certain applications.
 Example: 10-1=10.00(Hz); 10-12=20.00(Hz); 10-13=30.00(Hz); 10-14=2.00(Hz).

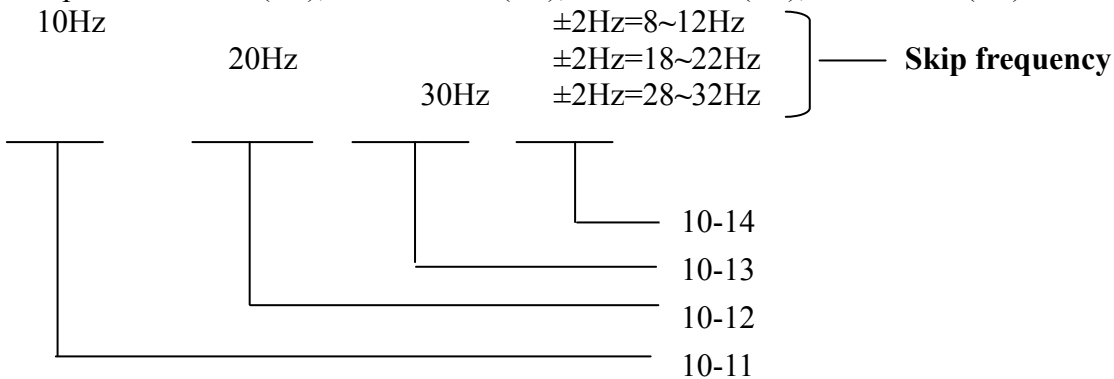

10-15 : Carrier Frequency reduced by temperature raising
=0 : disable =1 : Enable

When inverter is temperature overrun 80°C on keypad display(11-00=01000), Carrier Frequency reduced 4K.when inverter is temperature reduced less than 70°C, Carrier Frequency resume.

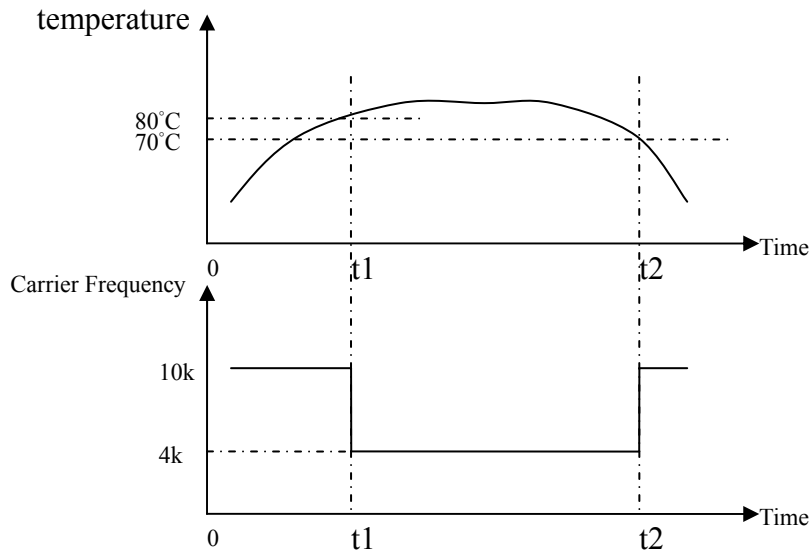

10-16 : Auto Voltage Regulation (AVR):

0 : AVR Function disable 1 : AVR Function enable

AVR function automatically regulates the AC motor drive output voltage to the Maximum Output Voltage

10-17 : Count Down Completion =00~9999

This parameter sets purpose value of E310 built-in counter, this counter can take external terminal S6 as a trigger in control circuit. When count value reaches purpose value ,multi-RELAY output terminal acts.

Group11-keypad display group

11-00 : Display Mode

=xxxx0 : Disable Motor Current Display	=xxxx1 : Enable Motor Current Display
=xxx0x : Disable Motor Voltage Display	=xxx1x : Enable Motor Voltage Display
=xx0xx : Disable Bus Voltage Display	=xx1xx : Enable Bus Voltage Display
=x0xxx : Disable temperature Display	=x1xxx : Enable temperature Display
=0xxxx : Disable PID feedback Display	=1xxxx : Enable PID feedback Display

11-01 : Custom Units (Line Speed) Value =0~65535

The max preset line value of 11-01 is equal to the rated frequency (06-04) of the motor. For instance, given line speed 1800 is equal to display 900 when output is 30Hz while the operation frequency is 60Hz.

11-02 : Custom Units (Line Speed) Display Mode

0 : Drive Output Frequency is Displayed
1 : Line Speed is Displayed in Integer (xxxxx)
2 : Line Speed is Displayed with One Decimal Place (xxxx.x)
3 : Line Speed is Displayed with Two Decimal Places (xxx.xx)
4 : Line Speed is Displayed with Three Decimal Places (xx.xxx)

When 11-02=1/2/3/4, line speed is displayed while the inverter is running or stopped.

11-07 : Counter display =0 Disable data Display =1 Enable data Display

Group12- User parameter group

12-00 : Drive Horsepower Code

12-00	Inverter Model	
20P5	E310-	20P5
2001		2001
2002		2002

12-00	Inverter Model	
4001	E310-	4001
4002		4002
4003		4003
4005		4005

12-01 : Software Version

12-02 : Fault Log (Latest 3 times)

1. When the inverter trips on a fault, the previous fault log stored in 2.xxx will be transferred to 3.xxx, the one in 1.xxx to 2.xxx. The present fault will be stored in the empty register 1.xxx. The fault stored in 3.xxx is the last one of the most recent three, while the one 1.xxx is the latest.
2. When pressing 'ENTER' at 12-02, the fault 1.xxx will be displayed first. Press ▲, to read 2.xxx→3.xxx→1.xxx press ▼ and the order is 3.xxx→2.xxx→1.xxx→3.xxx.
3. When pressing 'Reset' at 12-02, the three fault log will be cleared when the reset key is pressed. The log content will change to 1.---, 2.---, 3.---.
4. E.g. the fault log content is '1.OC-C'; this indicates the latest fault is OC-C, etc.

12-03 : Accumulated Operation Time 1 (Hours) : 0 ~ 23

12-04 : Accumulated Operation Time 2 (Days) : 0 ~ 65535

12-05 : Accumulated Operation Time Mode 0 : Power on time 1 : Operation time

1. When the operation time is to 23 as the elapsed time 1 is set. The next hour will be carried to operation 12-04. Meanwhile, the recorded value will be cleared to 0000, and the record value of operation duration 2 will be 01.
2. Description of operation time selection :

Preset value	Description
0	Power on, count the accumulated time.
1	Inverter operation, count the accumulated operation time

12-06 : Reset Drive to Factory Settings

1150 : Reset to the 50Hz factory setting

1160 : Reset to the 60Hz factory setting

12-07 : Parameter lock

0 : Enable all Functions

1 : 03-01~ 03-08 cannot be changed

2 : All Functions cannot be changed Except 03-01~ 03-08

3 : Disable All Function

12-08 : Parameter password = 00000 ~ 65535

This function is used to prevent parameter from being modified by disrelated personnels, keep parameter safety.

When a password has been set, parameters cannot be modified, and it is forbidden to reset to factory set.

(1) Setting password:

- ① open 12-08, "00000" is shown on keypad, input password, press "enter", display "End" .
- ② When open 12-08 again, display "00001", input password again, press "enter", display "LOC" display .
If setting is different from the first time, display "Err2", setting failed

(2) cancel password:

- ① open 12-08, display "00002", input the correct password, press "enter" key, display "End" , Disable the password is succeeded.
If typing a wrong password, display "LOC"(password is still holded)

Note: set 12-08=00000, password can't work

Group13- Auto Run (Auto Sequencer) function group

Auto Run(sequencer) mode selection:

13-00:

0 : Disabled.

1 : Single cycle. (Continues to run from the unfinished step if restarted).

2 : Periodic cycle. (Continues to run from the unfinished step if restarted).

3 : Single cycle, then holds the speed of final step to run.

(Continues to run from the unfinished step if restarted).

4 : Single cycle. (Starts a new cycle if restarted).

5 : Periodic cycle. (Starts a new cycle if restarted).

6 : Single cycle, then hold the speed of final step to run.

(Starts a new cycle if restarted).

13-01 : Auto _ Run Mode Frequency Command 1 (0.00 ~ 400.00Hz)

13-02 : Auto _ Run Mode Frequency Command 2 (0.00 ~ 400.00Hz)

13-03 : Auto _ Run Mode Frequency Command 3 (0.00 ~ 400.00Hz)

13-04 : Auto _ Run Mode Frequency Command 4 (0.00 ~ 400.00Hz)

13-05 : Auto _ Run Mode Frequency Command 5 (0.00 ~ 400.00Hz)

13-06 : Auto _ Run Mode Frequency Command 6 (0.00 ~ 400.00Hz)

13-07 : Auto _ Run Mode Frequency Command 7 (0.00 ~ 400.00Hz)

13-16 : Auto _ Run Mode Running Time Setting 0 (0.0 ~ 3600.0s)

13-17 : Auto _ Run Mode Running Time Setting 1 (0.0 ~ 3600.0s)

13-18 : Auto _ Run Mode Running Time Setting 2 (0.0 ~ 3600.0s)

13-19 : Auto _ Run Mode Running Time Setting 3 (0.0 ~ 3600.0s)

13-20 : Auto _ Run Mode Running Time Setting 4 (0.0 ~ 3600.0s)

13-21 : Auto _ Run Mode Running Time Setting 5 (0.0 ~ 3600.0s)

13-22 : Auto _ Run Mode Running Time Setting 6 (0.0 ~ 3600.0s)

13-23 : Auto_ Run Mode Running Time Setting 7 (0.0 ~ 3600.0s)		
13-32 : Auto_ Run Mode Running Direction 0 (0 : STOP	1 : forward	2 : reverse)
13-33 : Auto_ Run Mode Running Direction 1 (0 : STOP	1 : forward	2 : reverse)
13-34 : Auto_ Run Mode Running Direction 2 (0 : STOP	1 : forward	2 : reverse)
13-35 : Auto_ Run Mode Running Direction 3 (0 : STOP	1 : forward	2 : reverse)
13-36 : Auto_ Run Mode Running Direction 4 (0 : STOP	1 : forward	2 : reverse)
13-37 : Auto_ Run Mode Running Direction 5 (0 : STOP	1 : forward	2 : reverse)
13-38 : Auto_ Run Mode Running Direction 6 (0 : STOP	1 : forward	2 : reverse)
13-39 : Auto_ Run Mode Running Direction 7 (0 : STOP	1 : forward	2 : reverse)

Note:

1. Auto Run (sequencer) various modes can be selected by parameter 13-00.
2. Auto Run (sequencer) mode set up parameters are parameters (13-01 ~ 13-39).
3. Auto run mode (sequencer) operation as selected by parameter 13-00 can be set up as follows : -
 - a. **Setting multi-step frequency commands**, by using the available multi-step frequency commands 0~7 as required can be set by parameters (13-00 ~ 13-07).
 - b. **Setting multi-step run time**, by parameters (13-16 ~ 13-23) for each required step.
 - c. FWD/REV direction can be selected by setting of parameters (13-32 ~ 13-39).
 - d. d. Auto_ Run Mode Frequency Command 0 is 3-01, running time is 13-16, Running Direction 13-32.

Some examples in auto_run mode as follows:

(A) Single Cycle Running (13-00= 1, 4)

The inverter will run for a single full cycle based upon the specified setting mode. Then, it will stop.

- For example :

13-00=1 (or 4)

- Panel Frequency (3-01)=15 Hz 13-01=30Hz 13-02=50Hz 13-03=20Hz
 13-16=20s 13-17=25s 13-18=30s 13-19=40s
 13-32=1 13-33=1 13-34=1(FWD) 13-35=2(REV)
- 13-04 ~ 13-07=0Hz , 13-20 ~ 13-23=0s , 13-36 ~ 13-39=0

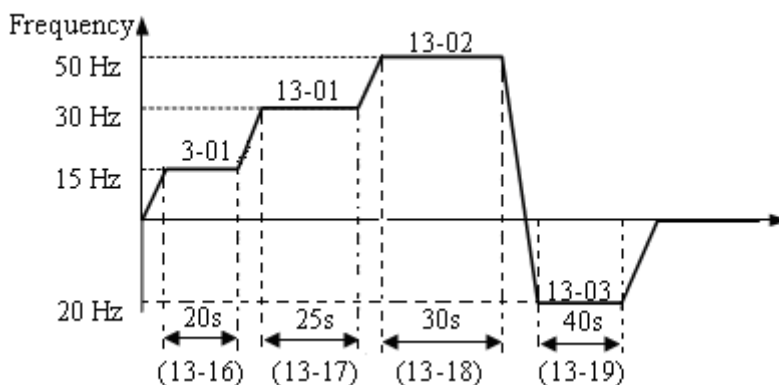

Figure 4-29 Single cycle auto run

(B) Periodic cycle Running (13-00=2, 5)

The inverter will repeat the same cycle periodically.

For example:

13-00=2(or 5)

13-01 ~ 13-03 , 13-16 ~ 13-23 , 13-32 ~ 13-39 : Same setting as the example (A)

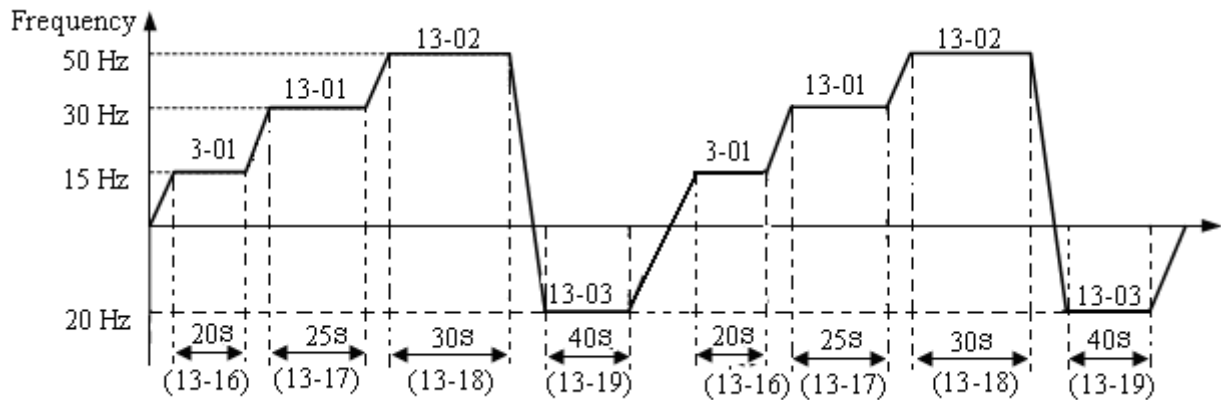

Figure 4-30 Periodic cycle auto run

(C) Auto_Run Mode for Single Cycle (13-00 = 3, 6)

The speed of final step will be held to run.

For example:

13-00 = 3(or 6)

Panel Frequency (3-01) = 15 Hz	13-01=30Hz	13-02=50Hz	13-07=20Hz
13-16=20s	13-17=25s	13-18=30s	13-23=40s
13-32=1	13-33=1	13-34 = 1	13-39=1(FWD)
13-04 ~ 13-06=0Hz , 13-20 ~ 13-22=0s , 13-35 ~ 13-38 = 0			

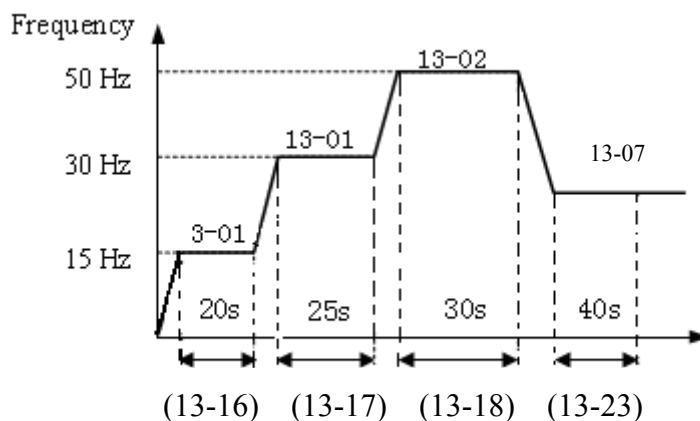

Figure 4-31 Single cycle auto run: final step hold

Note: 13-00 = 1~3 : If the inverter stops and re-starts, it will continue running from the unfinished step, according to the setting of 13-00.

= 4~6 : If the inverter stops and re-starts, it will begin a new cycle and continue running according to the setting of 13-00.

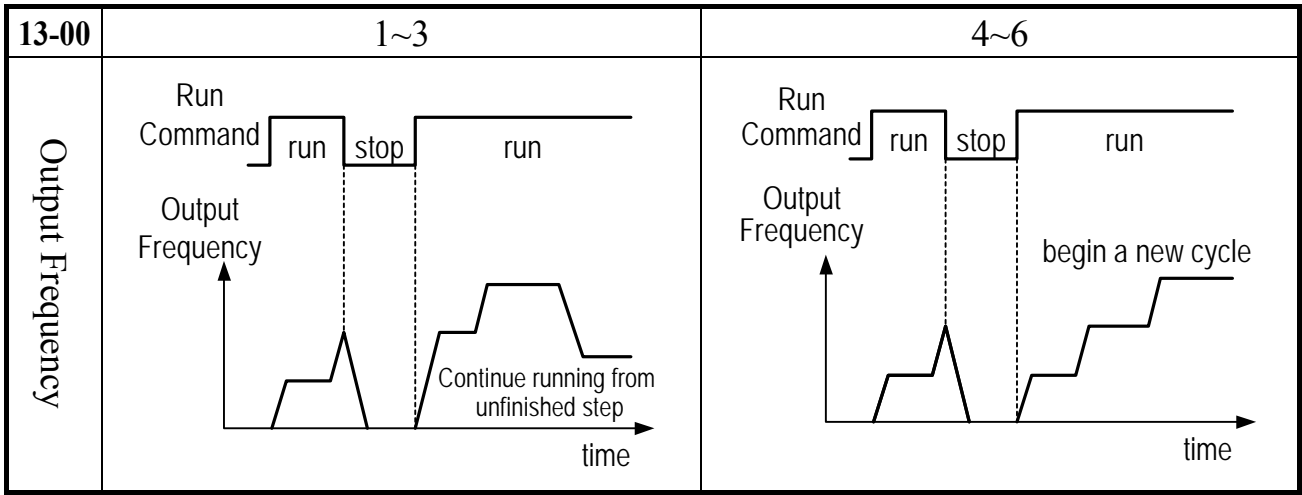

Figure 4-32 AUTO_RUN cycle with interrupt

- ACC/DEC time follow the setting of 00-09/00-10 or 10-05/10-06 in Auto Run Mode.

Chapter 5 Troubleshooting and maintenance

5.1. Error display and corrective action

5.1.1. Faults which can not be recovered manually

1. Faults which can not be recovered manually

Display	Fault	Cause	Corrective action
-OV-	Voltage too high when stopped	Detection circuit malfunction	Return the inverter
-LV-	Voltage too low when stopped	<ol style="list-style-type: none"> 1. Power voltage too low 2. Pre-charge resistor or fuse burnt out. 3. Detection circuit malfunction 	<ol style="list-style-type: none"> 1. Check if the power voltage is correct 2. Replace the pre-charge resistor or the fuse 3. Return the inverter
-OH-	The inverter is overheated when stopped	<ol style="list-style-type: none"> 1. Detection circuit malfunction 2. Ambient temperature too high or bad ventilation 	<ol style="list-style-type: none"> 1. Return the inverter 2. Improve ventilation conditions
CTER	Current Sensor detection error	Current sensor error or circuit malfunction	Return the inverter
EPR	EEPROM problem	Faulty EEPROM	Replace EEPROM

2. Faults which can be recovered manually and automatically

Display	Fault	Cause	Corrective Action
OC-S	Over current at start	<ol style="list-style-type: none"> 1. Short circuit between the motor coil and the case 2. Short circuit between motor coil and ground 3. the IGBT module damaged 	<ol style="list-style-type: none"> 1. Inspect the motor 2. Inspect the wiring 3. Replace the transistor module
OC-D	Over-current at deceleration	The preset deceleration time is too short.	Set a longer deceleration time
OC-A	Over-current at acceleration	<ol style="list-style-type: none"> 1. Acceleration time too short 2. The capacity of the motor exceeds the capacity of the inverter 3. Short circuit between the motor coil and the case 4. Short circuit between motor wiring and ground 5. the IGBT module damaged 	<ol style="list-style-type: none"> 1. Set a longer acceleration time 2. Replace inverter with one that has the same rating as that of the motor 3. Check the motor 4. Check the wiring 5. Replace the IGBT module
OC-C	Over-current at fixed speed	<ol style="list-style-type: none"> 1. Transient load change 2. Transient power change 	<ol style="list-style-type: none"> 1. Increase the capacity of the inverter 2. Repeat parameter auto tuning (06-05= 1) 3. Reduce stator resistance (06-06) if the above actions are ineffective
OV-C	Excessive Voltage during operation/ deceleration	<ol style="list-style-type: none"> 1. Deceleration time setting too short or excessive load inertia 2. Power voltage varies widely (fluctuates) 	<ol style="list-style-type: none"> 1. Set a longer deceleration time 2. Add a brake resistor or brake module 3. Add a reactor at the power input side 4. Increase inverter capacity
Err4	Unacceptable CPU interrupt	External noise interference	Return unit if this happens regularly

3. Faults which can be recovered manually but not automatically

Display	Fault	Cause	Corrective Action
OC	Over-current during stop	<ol style="list-style-type: none"> 1. Detection circuit malfunction 2. Bad connection for CT signal cable 	<ol style="list-style-type: none"> 1. Check the noise between Power line and motor line 2. Return the inverter for repair
OL1	Motor overload	<ol style="list-style-type: none"> 1. Excessive load 2. Incorrect settings for 06-01, 07-05~08 	<ol style="list-style-type: none"> 1. Increase the motor capacity 2. set 06-01, 07-05~08 correctly
OL2	Inverter overload	Excessive Load	Increase the inverter capacity
OL3	Over torque	<ol style="list-style-type: none"> 1. Excessive Load 2. Incorrect settings for 07-11, 07-12 	<ol style="list-style-type: none"> 1. Increase the inverter capacity 2. set 07-11, 07-12 correctly
LV-C	Voltage too low during operation	<ol style="list-style-type: none"> 1. Power voltage too low 2. Power voltage varies widely (fluctuates) 	<ol style="list-style-type: none"> 1. Improve power quality or increase the value of 4-04 2. Set a longer acceleration time 3. Add a reactor at the power input side 4. Increase the motor capacity

5.1.2. Special conditions

Display	Fault	Description
STP0	Zero speed at stop	Occurs when preset frequency <0.1Hz
STP1	Fail to start directly On power up.	<ol style="list-style-type: none"> 1. If the inverter is set for external terminal control mode (00-03/00-04=1) and direct start is disabled (04-09=1) The inverter cannot be started and will flash STP1. The run input is active at power-up, refer to descriptions of (04-09). 2. Direct start is possible when 04-09=0.
STP2	Keypad Stop Operated when inverter in external Control mode.	<ol style="list-style-type: none"> 1. With the function of Stop key enabled by (04-02=0) And if the Stop key is pressed while the inverter is set to external control mode (00-03/00-04=1) then, the inverter will stop according to the setting of 04-01 and the error message, 'STP2' flashes after stop. Release and re-activate the run contact to restart the inverter. 2. If the inverter is in communication mode and the Stop key is enabled (04-02=0), the inverter will stop in the way set by 04-01 when Stop key is pressed during operation and then flashes STP2. The Host controller has to send a Stop command then a Run command to the inverter for it to be restarted. 3. Stop key will be disabled when 04-02=1
E.S.	External Rapid stop	The inverter will decelerate to stop and then flash E.S., when input external Rapid stop signal via the multifunctional input terminal activates (refer to descriptions of 01-00~01-05).

b.b.	External base block	The inverter stops immediately and then flashes b.b., when external base block is input by the multifunctional input terminals. (Refer to descriptions of 01-00~01-05).
PDER	PID feedback loss	PID feedback loss detect
COT	Communication error	Communication error detect (refer group 8)

5.1.3. Operation errors

Display	Error	Cause	Corrective Action
LOC	Parameter and frequency reverse already locked	<ol style="list-style-type: none"> 1. Attempt to modify frequency parameter while 12-07>0 2. Attempt to reverse while 10-01=1 	<ol style="list-style-type: none"> 1. Set 12-07=0 2. Set 10-01=0
Err1	Keypad operation error	<ol style="list-style-type: none"> 1. Press ▲ or ▼ while 00-05/00-06>0 or running at preset speed. 2. Attempt to modify the Parameter. <p>Can not be modified during operation (refer to the parameter list).</p>	<ol style="list-style-type: none"> 1. The ▲ or ▼ is available for modifying the parameter only when 00-05/00-06=0 2. Modify the parameter in STOP mode.
Err2	Parameter setting error	<ol style="list-style-type: none"> 1. 00-08 is within the range of 10-11 ± 10-14 or 10-12 ± 10-14 or 10-13 ± 10-14 2. 00-07 ≤ 00-08 3. Setting error while Performing Auto tuning. (e.g. 00-03/00-04 ≠ 0, 00-05/00-06 ≠ 0) 	<ol style="list-style-type: none"> 1. Modify 10-11~10-13 or 10-14 2. Set 00-07 > 00-08 3. Set 00-03/00-04=0 and 05/00-06=0, during Auto tuning
Err5	Modification of parameter is not available in communication	<ol style="list-style-type: none"> 1. Control command sent during communication. 2. Attempt to modify the function 08-02 ~ 08-05 during communication 	<ol style="list-style-type: none"> 1. Issue enable command before communication 2. Set parameters 08-02 ~ 08-05 function before communication
Err6	Communication failed	<ol style="list-style-type: none"> 1. Wiring error 2. Communication parameter setting error. 3. Check-Sum error 4. Incorrect communication protocol 	<ol style="list-style-type: none"> 1. Check hardware and wiring 2. Check Functions 08-02 ~ 08-05
Err7	Parameter conflict	<ol style="list-style-type: none"> 1. Attempt to modify the function 12-00/12-06. 2. Voltage and current detection circuit is abnormal 	If Reset is not possible, please Return the inverter

5.2 General troubleshooting

Status	Checking point	Remedy
Motor can not run	Is power applied to L1, L2, and L3 terminals (is the charging indicator lit)?	<ul style="list-style-type: none"> • Is the power applied? • Turn the power OFF and then ON again. • Make sure the power voltage is correct. • Make sure screws are secured firmly.
	Is there voltage across the output terminals T1, T2, and T3?	<ul style="list-style-type: none"> • Turn the power OFF and then ON again.
	Is overload causing the motor to stall?	<ul style="list-style-type: none"> • Reduce the load so the motor will run.
	Are there any abnormalities in the inverter?	<ul style="list-style-type: none"> • See error descriptions to check wiring and correct if necessary.
	Is forward or reverse run command issued?	
	Has the analog frequency signal been input?	<ul style="list-style-type: none"> • Is analog frequency input signal wiring correct? • Is voltage of frequency input correct?
	Is the operation mode setting correct?	<ul style="list-style-type: none"> • Operate through the digital keypad .
Motor runs in wrong direction	Are wiring for output terminals T1, T2, and T3 correct?	<ul style="list-style-type: none"> • Wiring must match U, V, and W terminals of the motor.
	Are wiring for forward and reverse signals correct?	<ul style="list-style-type: none"> • Check for correct wiring.
The motor speed can not be regulated.	Is the wiring for the analog frequency inputs correct?	<ul style="list-style-type: none"> • Check for correct wiring.
	Is the setting of operation mode correct?	<ul style="list-style-type: none"> • Check the operation mode of the operator.
	Is the load too excessive?	<ul style="list-style-type: none"> • Reduce the load.
Motor running speed too high or too low	Check the motor specifications (poles, voltage...) correct?	<ul style="list-style-type: none"> • Confirm the motor specifications.
	Is the gear ratio correct?	<ul style="list-style-type: none"> • Confirm the gear ratio.
	Is the setting of the highest output frequency correct?	<ul style="list-style-type: none"> • Confirm the highest output frequency.
Motor speed varies unusually	Is the load too excessive?	<ul style="list-style-type: none"> • Reduce the load.
	Does the load vary excessively?	<ul style="list-style-type: none"> • Minimize the variation of the load. • Increase capacities of the inverter and the motor.
	Is the input power erratic or is a phase loss occurring?	<ul style="list-style-type: none"> • Add an AC reactor at the power input side if using single-phase power. • Check wiring if using three-phase power.

5.3 Quick troubleshooting of E310

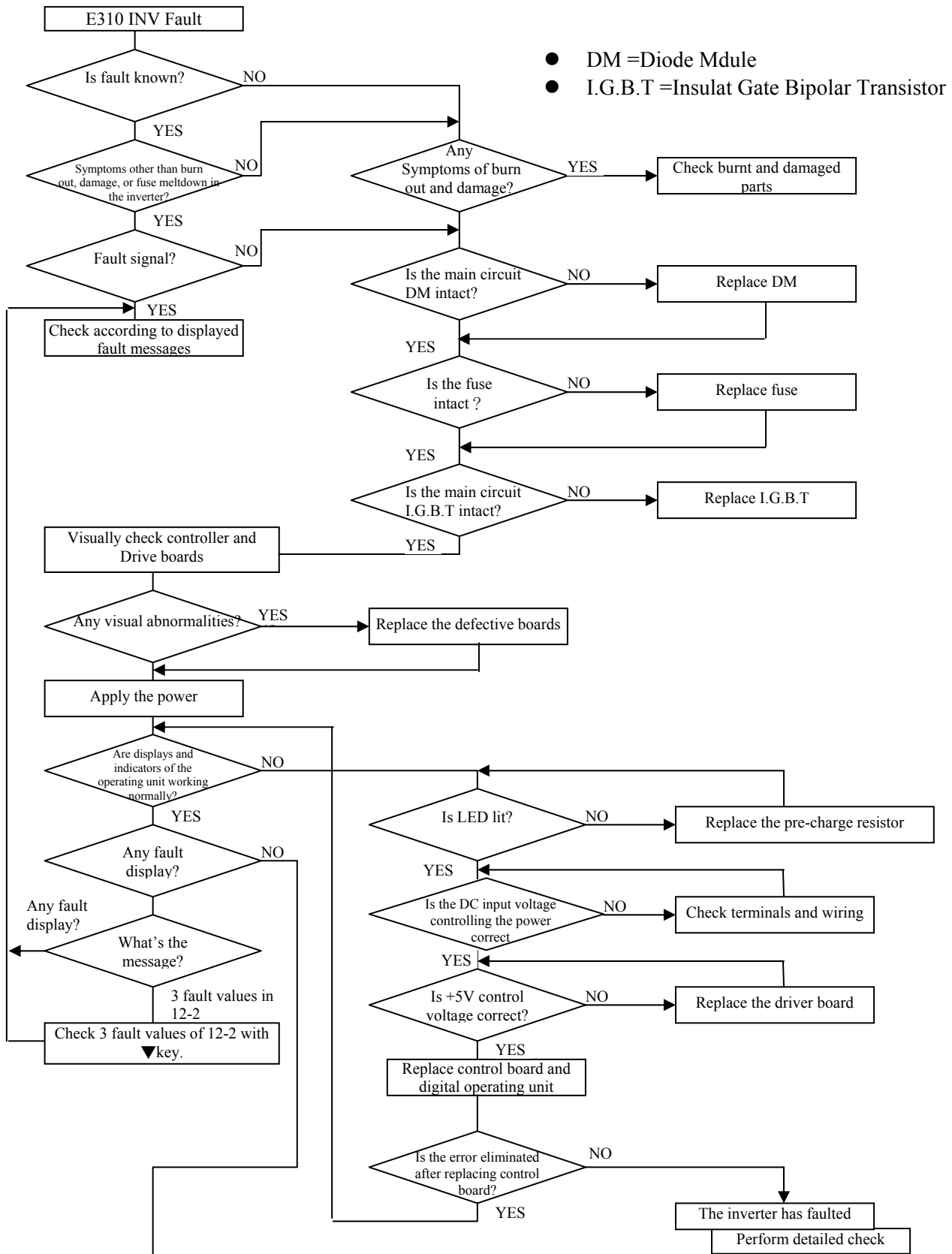

- DM =Diode Mdule
- I.G.B.T =Insulat Gate Bipolar Transistor

*to next page

*From previous page

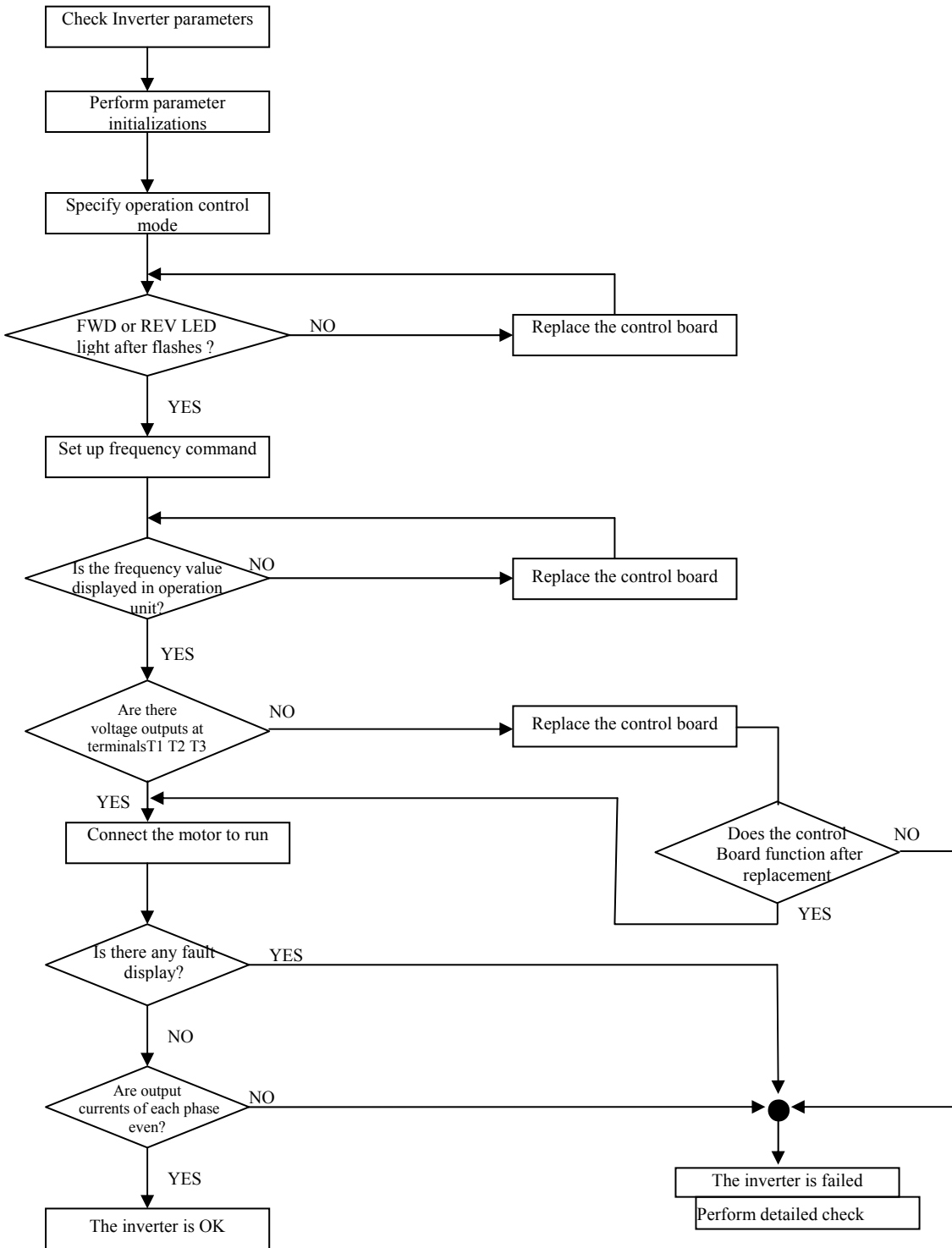

Figure 5-1 E310 fault display and troubleshooting flow chart

Troubleshooting for OC, OL error displays

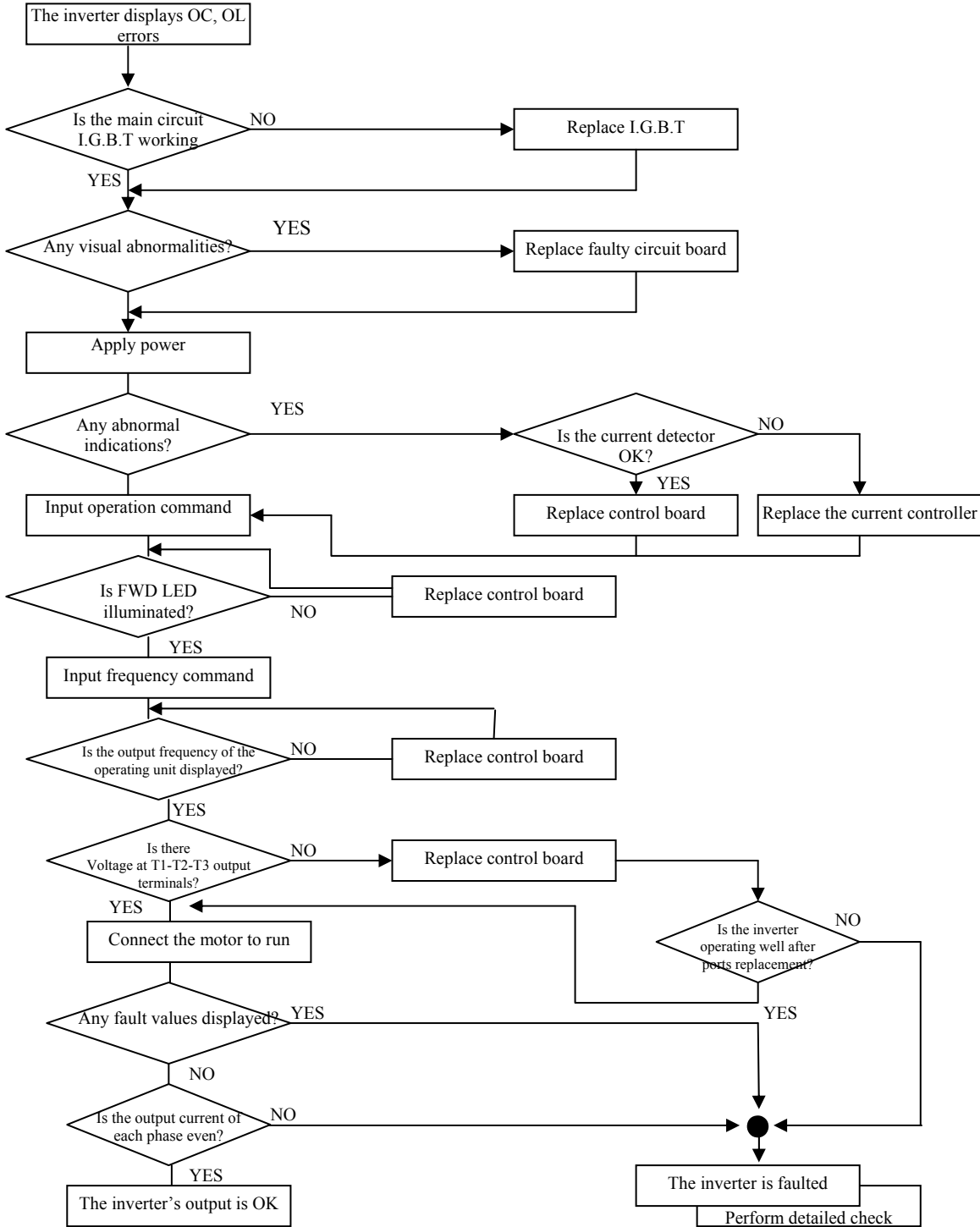

Figure 5-2 OC, OL Fault Display Flow Chart

Troubleshooting for OV, LV error

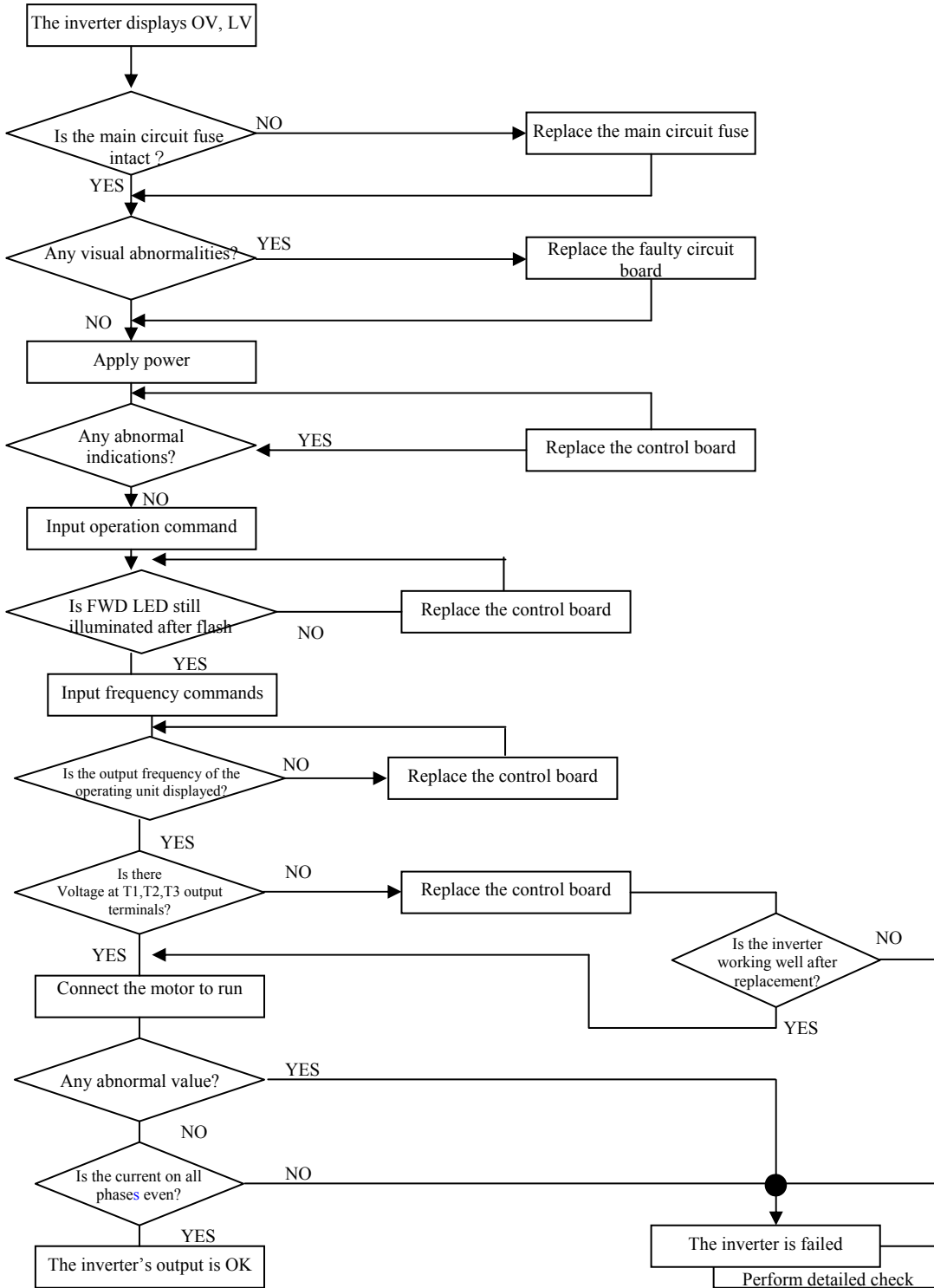
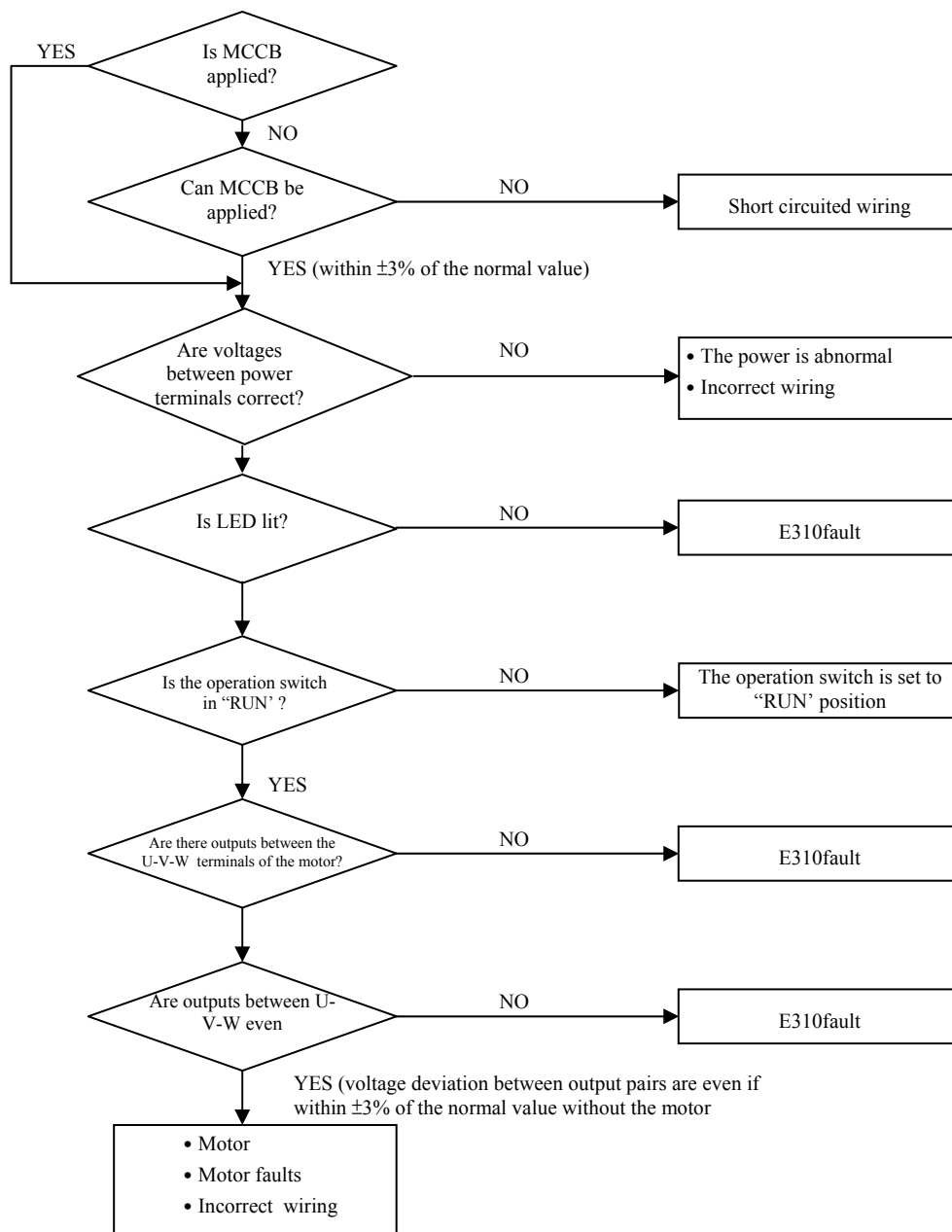

Figure 5-3 OV, LV Fault Display Flow Chart

The motor can not run



● Figure 5-4 Motor RUN failure Flow chart

Motor Overheating

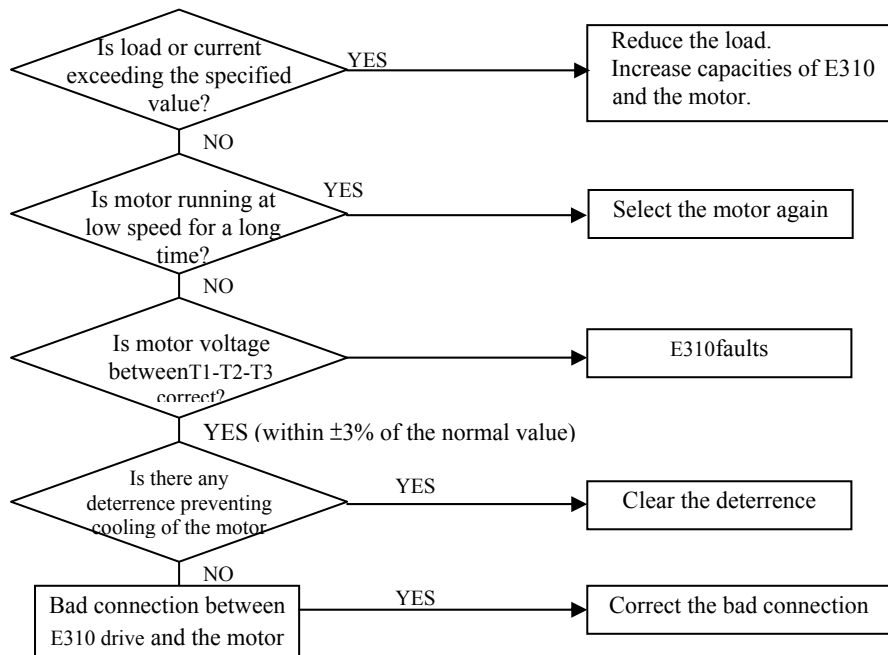

Figure 5-5 Motor Overheat Troubleshooting Flow Chart

Motor runs unevenly

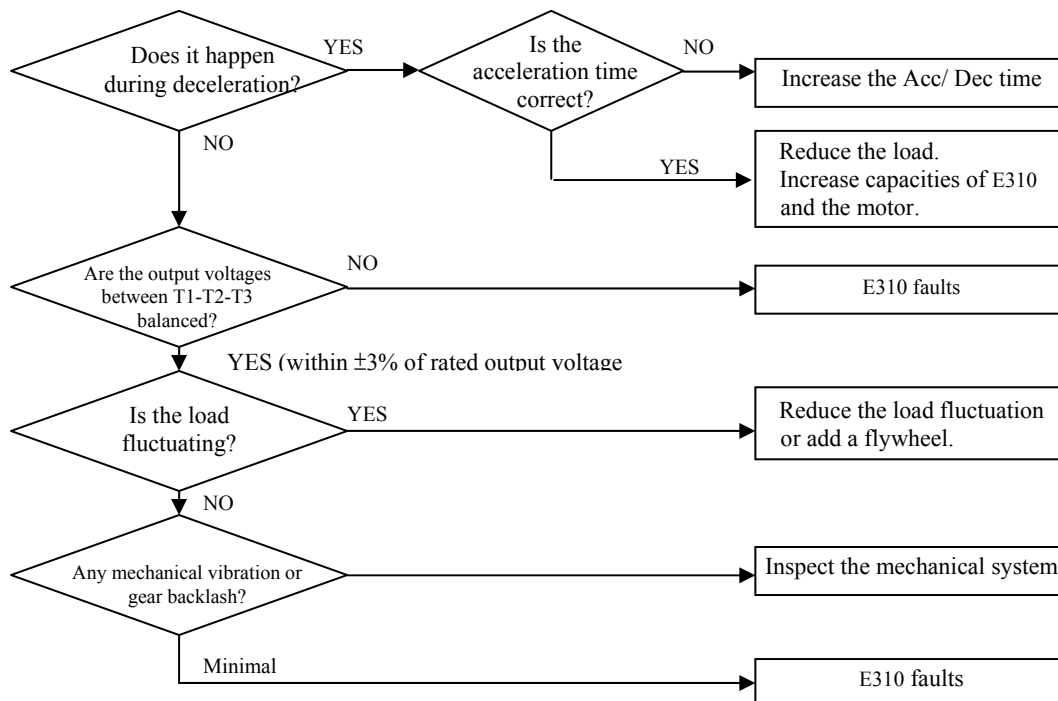

Figure 5-6 Motor Instability Troubleshooting Flow Chart

5.4 Routine and periodic inspection

To ensure stable and safe operations, check and maintain the inverter at regular intervals.

The table below lists the items to be checked to ensure stable and safe operations.

Check these items 5 minutes after the “Charge” indicator goes out to prevent injury to personnel by residual electric power.

Items	Details	Checking period		Methods	Criteria	Remedies
		Daily	1Year			
Ambient conditions around the machine	Confirm the temperature and humidity at the machine	<input type="radio"/>		Measure with thermometer and hygrometer according to installation notices.	Temperature: -10 – 40°C (14-120°F) Humidity: Below 95% RH	Improve the ambient or relocate the drive to a better area.
	Are there inflammable materials in the vicinity?	<input type="radio"/>		Visual check	Keep area clear	
Installation and grounding of the inverter	Any unusual vibration from the machine	<input type="radio"/>		Visual, hearing check	No vibration	Secure screws
	Is the grounding resistance correct?		<input type="radio"/>	Measure the resistance with a multi-tester	200Vclass: below 100Ω 400V class: below 10Ω	Improve the grounding
Input power voltage	Is the voltage of the main circuit correct?	<input type="radio"/>		Measure the voltage with a multi-tester	Voltage must conform with the specifications	Improve input voltage
External terminals and internal mounting screws of the inverter	Are secure parts loose?		<input type="radio"/>	Visual check Check with a screwdriver	Secure terminals and no rust	Secure or send back for repair
	Is the terminal base damaged?		<input type="radio"/>			
	Visual rust stains present?		<input type="radio"/>			
Internal wiring of the inverter	Any unusual bends or breaks?		<input type="radio"/>	Visual check	No abnormalities	Replace or send back for repair
	Any damage of the wire insulation?		<input type="radio"/>			
Heat sink	Excessive dust or debris	<input type="radio"/>		Visual check	No abnormalities	Clean up debris or dust
Printed circuit board	Excessive conductive metal shavings or oil sludge		<input type="radio"/>	Visual check	No abnormalities	Clean or replace the circuit board
	Discolored, overheated, or burned parts		<input type="radio"/>			
Cooling fan	Unusual vibration and noise		<input type="radio"/>	Visual or hearing check	No abnormalities	Replace the cooling fan
	Excessive dust or debris	<input type="radio"/>		Visual check		Clean fan
Power component	Excessive dust or debris		<input type="radio"/>	Visual check	No abnormalities	Clean component
	Check resistance between each terminals		<input type="radio"/>	Measure with a multi-tester	No short circuit or broken circuit in three-phase output	Replace power component or inverter
Capacitor	Any unusual odor or leakage	<input type="radio"/>		Visual check	No abnormalities	Replace capacitor or inverter
	Any deformity or protrusion	<input type="radio"/>				

5.5 Maintenance and Inspection

Inverter doesn't need daily inspection and maintenance.

To ensure long-term reliability, follow the instructions below to perform regular inspection. Turn the power off and wait for the charge indicator (LED) to go out before inspection to avoid potential shock hazard from the charge stored in high-capacity capacitors.

- (1) Clean up the accumulation of any dust inside the inverter.
- (2) Check if there are any loose terminal screws and tighten them.
- (3) Insulation tests
 - (a) Disconnect all leads connecting the INVERTER with external circuits when performing insulation tests on external circuits.
 - (b) Internal insulation test should be performed against the main circuit of the INVERTER body only. Use a high resistance DC 500V meter with insulating resistance higher than $5M\Omega$.

Caution! Do not perform this test against the control circuit.

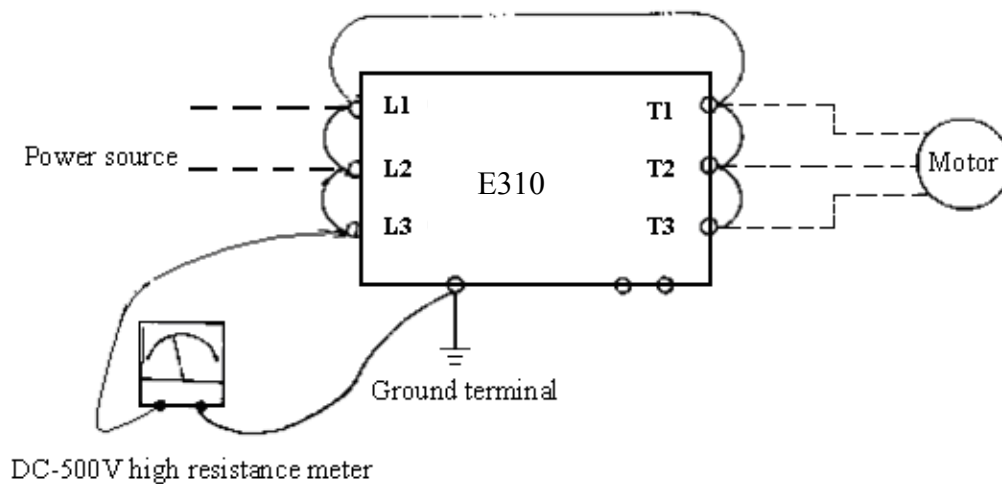

Insulation Test Diagram

Chapter 6 Peripherals Components

6.1 reactor specification at Input side

Model	AC inductance at input side		DC reactor specification at input side	
	Current (A)	Inductance (mH)	Current (A)	Inductance (mH)
E310-2P5-XXX	2.5	4.2	3.1	5.65
E310-201-XXX	5.0	2.1	4.5	3.89
E310-202-XXX	10.0	1.1	7.5	2.33
E310-401-XXX	2.5	8.4	2.3	15.22
E310-402-XXX	5.0	4.2	3.8	9.21
E310-403-XXX	7.5	3.6	5.2	6.73
E310-405-XXX	10.0	2.2	8.8	3.98

6.2 Braking unit and braking resistor

Inverter Model	Suitable Motor Capacity (HP)	Suitable Motor Capacity (KW)	Braking resistor Specification			Braking resistor Duty Cycle (%)	Braking torque (%)
			(W)	(Ω)	Number used		
2P5	0.5	0.375	60	200	-	8	218
201	1	0.75	60	200	-	8	119
202	2	1.5	150	100	-	10	119
401	1	0.75	60	750	-	8	125
402	2	1.5	150	400	-	10	119
403	3	2.2	200	250	-	8	128
405	5	3.7	300	150	-	8	127

※ Formula for brake resistor: $W = (V_{pnb} * V_{pnb}) * ED\% / R$

1. **W**: braking resistor power (Watts)

2. **V_{pnb}**: braking voltage (220V=380VDC, 440V=760VDC)

3. **ED%**: braking effective period

4. **R**: braking resistor rated ohms

6.3 Digital operator and extension cable

A. Content

- ① Inverter
- ② LED Keypad (E31DOP-01)
- ③ Remote Cable for Keypad
- ※③ using standard network cable connection.

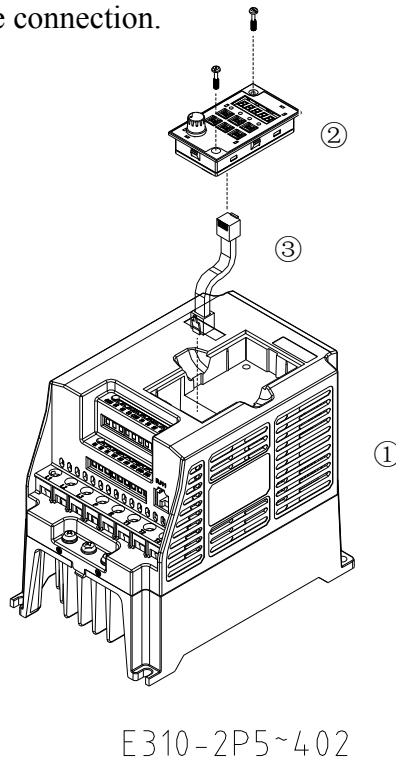

Figure 6-1 Digital Operator Extension Cable

B. Operation procedure:

1. Turn off the power Supply; the following procedures should be performed after there is no display on the keypad.
2. Remove the keypad.
3. Connect the inverter and the keypad with REMOTE cable in accordance with the diagram below.
4. Apply power to operate once the installation is complete.

Extension KEYPAD installation

(1) KEYPAD installation Dimensions:

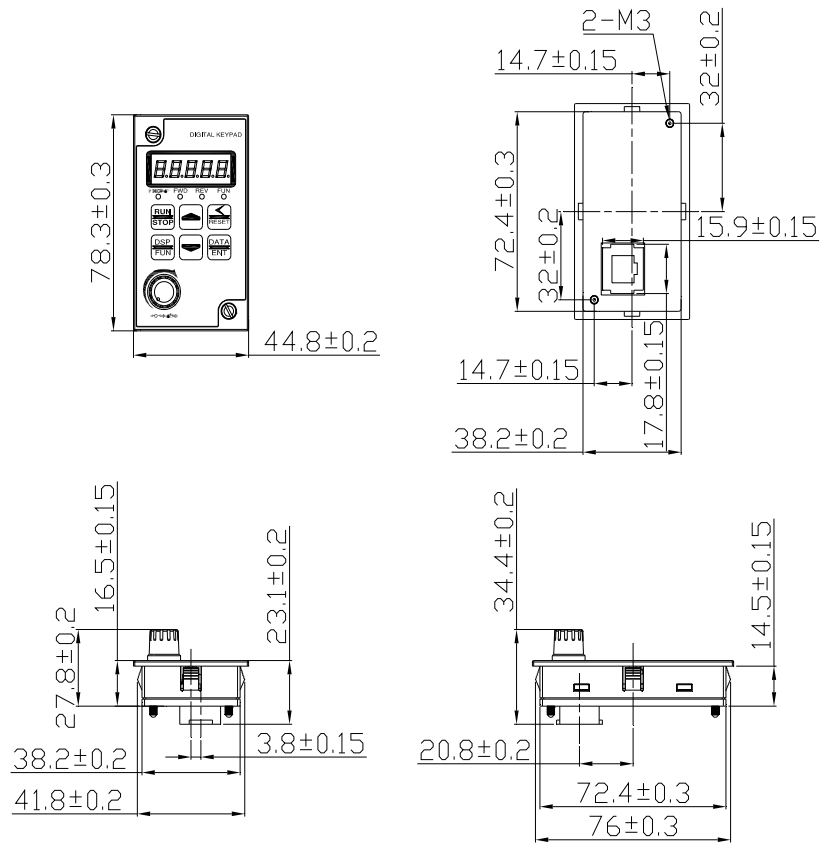

2. Dimension for remote keypad

a. Keypad hatch Installation Dimension

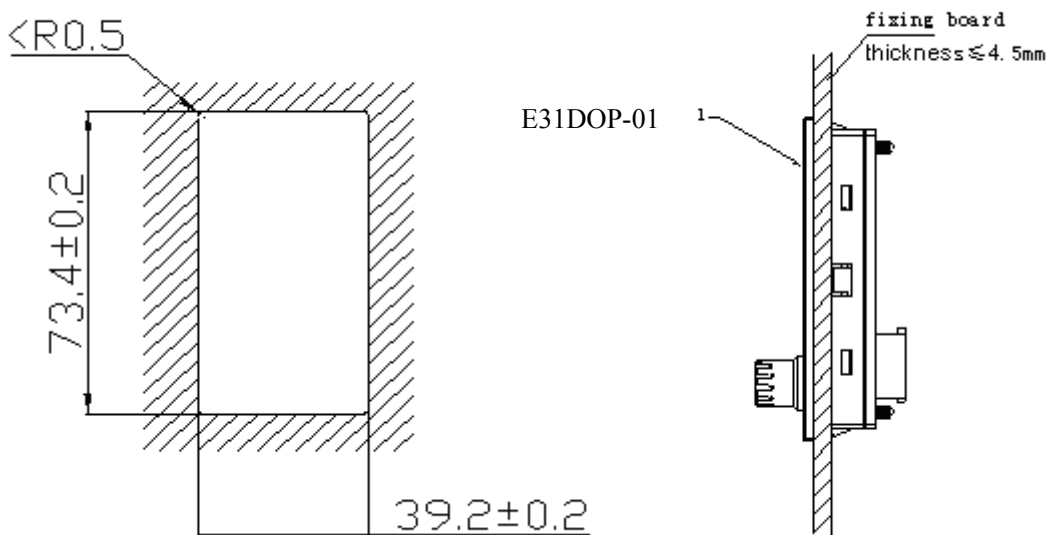

b. Keypad Installation Dimension for nut (superaddition gasket and nut)

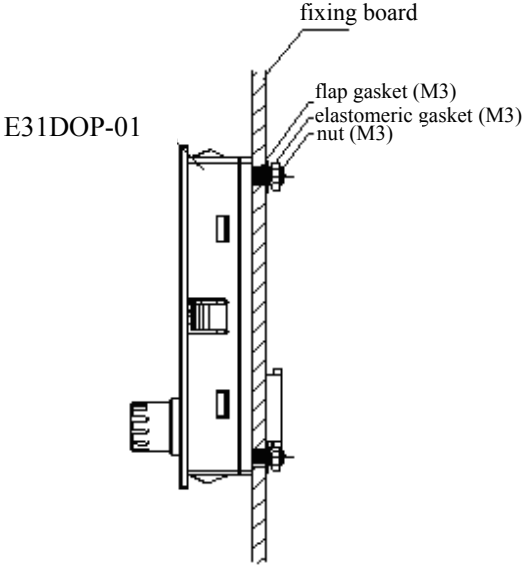
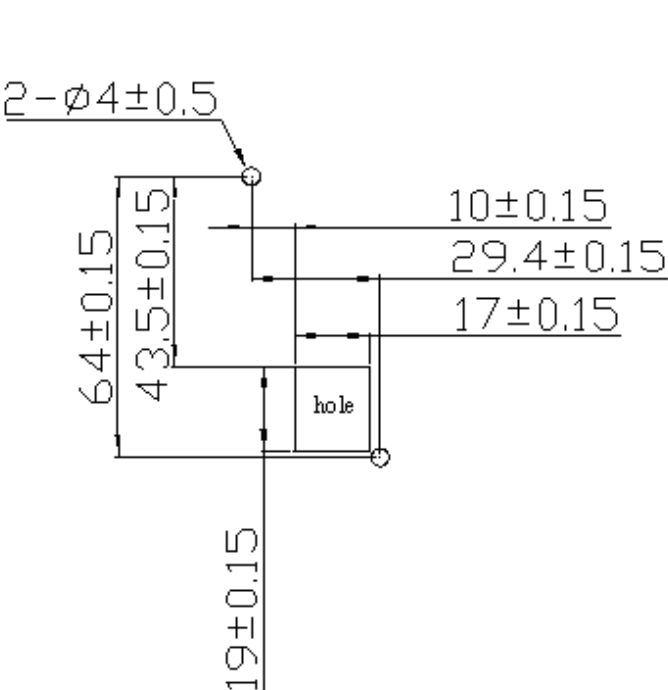

c. none gasket and nut, Keypad Installation Dimension

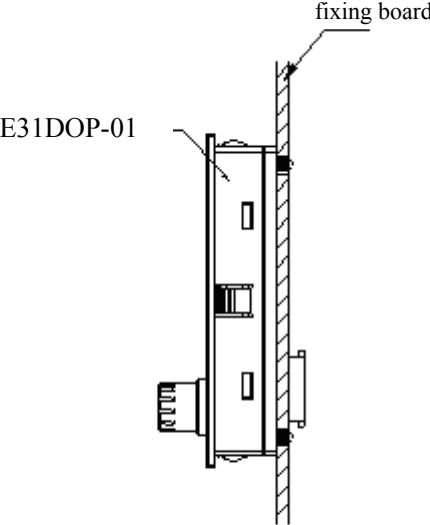
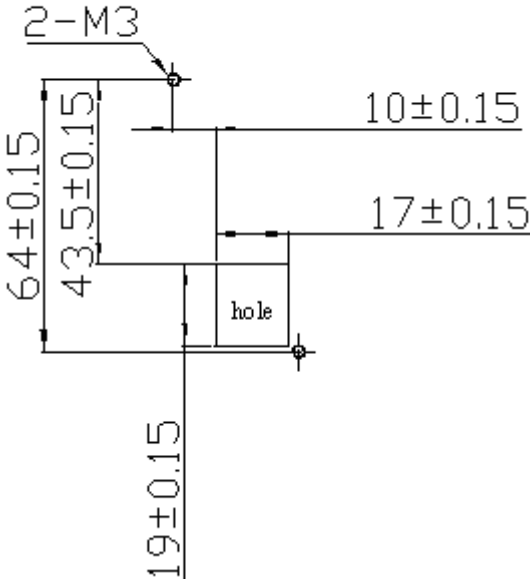

Appendix 1: E310 parameter setting list

Customer				Inverter Model			
Site Location				Contact Phone			
Address							
Parameter code	Setting content	Parameter code	Setting content	Parameter code	Setting content	Parameter code	Setting content
00-00		02-11		04-10		07-08	
00-01		02-12		04-11		07-09	
00-02		02-13		04-12		07-10	
00-03		02-14		04-13		07-11	
00-04		02-15		04-14		07-12	
00-05		02-16		04-15		07-13	
00-06		03-00		04-16		08-00	
00-07		03-01		04-17		08-01	
00-08		03-02		05-00		08-02	
00-09		03-03		05-01		08-03	
00-10		03-04		05-02		08-04	
00-11		03-05		05-03		08-05	
00-12		03-06		05-04		08-06	
00-13		03-07		05-05		08-07	
00-14		03-08		05-06		08-08	
01-00		03-17		05-07		08-09	
01-01		03-18		05-08		09-00	
01-02		03-19		05-09		09-01	
01-03		03-20		05-10		09-02	
01-04		03-21		05-11		09-03	
01-05		03-22		05-12		09-04	
01-06		03-23		06-00		09-05	
01-07		03-24		06-01		09-06	
01-08		03-25		06-02		09-07	
01-09		03-26		06-03		09-08	
01-10		03-27		06-04		09-09	
01-11		03-28		06-05		09-10	
01-12		03-29		06-06		09-11	
01-13		03-30		06-07		09-13	
01-14		03-31		06-08		09-14	
02-00		03-32		06-09		09-15	
02-01		04-00		06-10		09-16	
02-02		04-01		06-11		09-17	
02-03		04-02		07-00		10-01	
02-04		04-03		07-01		10-02	
02-05		04-04		07-02		10-03	
02-06		04-05		07-03		10-04	
02-07		04-06		07-04		10-05	
02-08		04-07		07-05		10-06	
02-09		04-08		07-06		10-07	
02-10		04-09		07-07		10-08	

Parameter code	Setting content	Parameter code	Setting content	Parameter code	Setting content	Parameter code	Setting content
10-09		11-07		13-02		13-22	
10-10		12-00		13-03		13-23	
10-11		12-01		13-04		13-32	
10-12		12-02		13-05		13-33	
10-13		12-03		13-06		13-34	
10-14		12-04		13-07		13-35	
10-15		12-05		13-16		13-36	
10-16		12-06		13-17		13-37	
10-17		12-07		13-18		13-38	
11-00		12-08		13-19		13-39	
11-01		13-00		13-20			
11-02		13-01		13-21			



TECO Electric & Machinery Co., Ltd.

10F.,No.3-1 , Yuancyu St., Nangang District
Taipei City 115, Taiwan

Tel : +886-2-6615-9111 Ext : 1721

Fax : +886-2-6615-0933

[Http://www.teco.com.tw](http://www.teco.com.tw)

Distributor

4KA72X254T01 VER:01 2010.6

This manual may be modified when necessary because of improvement of the product, modification, or changes in specification, this manual is subject to change without notice.