

B

MOTORIDUTTORI ORTOGONALI
HELICAL BEVEL GEARED MOTORS
MOTOREDUCTEURS ORTHOGONAUX
KEGELSTIRNRADGETRIEBEMOTOREN
MOTORREDUCTORES ORTOGONALES
斜伞齿轮减速机

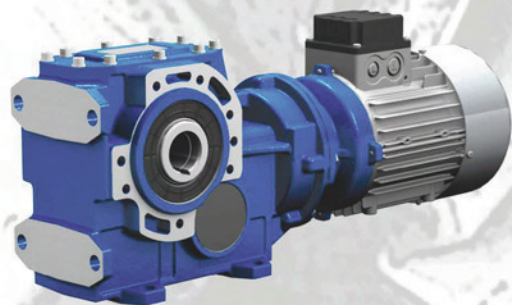

MOTOVARIO®

HEART OF MOTION

Versioni / Versions / Versions /
Ausführungen / Versiones / 版本

A40 - A50 - A70

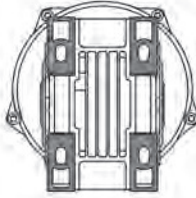
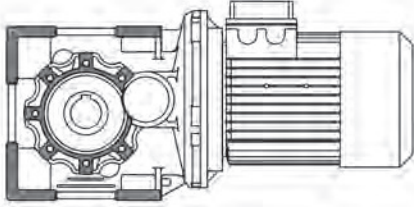

B ... C

- Fissaggio piede / albero cavo.
- Foot mounting / hollow shaft.
- Fixation à pattes / arbre creux.
- Fußbefestigung / Hohlwelle.
- Fijación por patas / eje hueco.
- 底脚安装/空心轴。

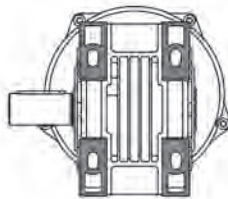
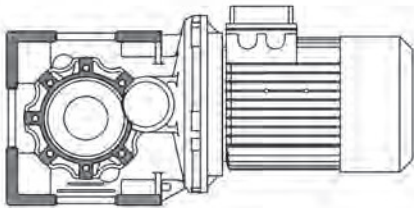

B ... D

- Fissaggio piede / albero pieno D.
- Foot mounting / D solid shaft.
- Fixation à pattes / arbre en D.
- Fußbefestigung / D Vollwelle.
- Fijación por patas / eje macizo D.
- 底脚安装/D 实心轴。

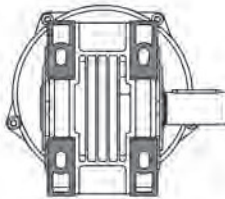
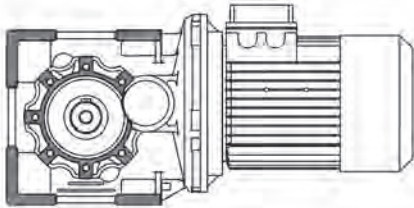

B ... S

- Fissaggio piede / albero pieno S.
- Foot mounting / S solid shaft.
- Fixation à pattes / arbre en S.
- Fußbefestigung / S Vollwelle.
- Fijación por patas / eje macizo S.
- 底脚安装/S 实心轴。

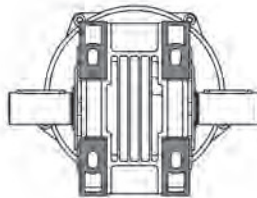
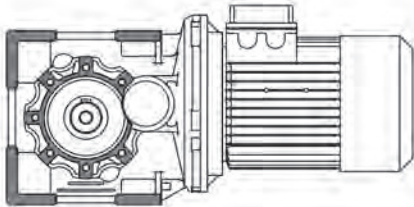

B ... P

- Fissaggio piede / albero doppio.
- Foot mounting / double output shaft.
- Fixation à pattes / arbre double.
- Fußbefestigung / doppelte Abtriebswelle.
- Fijación por patas / eje doble.
- 底脚-安装/双输出轴

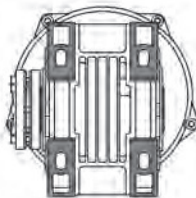
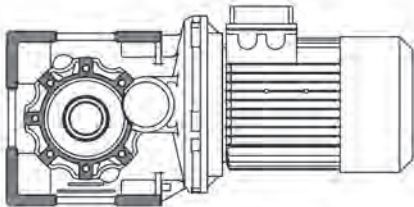

B ... L

- Fissaggio piede / albero calettatore.
- Foot mounting /shrink disc shaft.
- Fixation à pattes / arbre avec frette.
- Fußbefestigung / Schrumpfscheibe.
- Fijación por patas / eje hueco con aro de apriete.
- 底脚安装/锁紧盘轴。

- NB. Le grandezze A42 - A52 - A53 non sono disponibili nelle versioni D-S-P.
- N.B. sizes A42 - A52 - A53 are not available in versions D-S-P.
- Les dimensions A42 - A52 - A53 ne sont pas disponibles dans les versions D-S-P.
- Achtung: Die Größen A42 - A52 - A53 gibt es nicht mit den festen Abtriebswellen D-S-P.
- Los tamaños A42 - A52 - A53 no existen en las versiones D-S-P.
- 注意：规格 A42 - A52 - A53 不可用于版本 D-S-P。

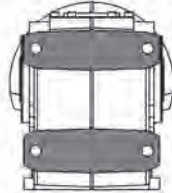
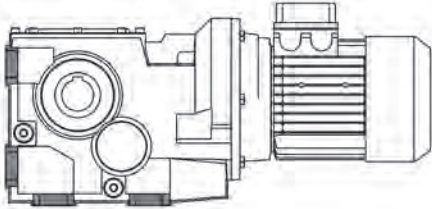
**Versioni / Versions / Versions /
Ausführungen / Versiones / 版本**
063 - 083 - 103 - 123

B ... FC

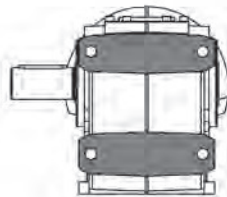
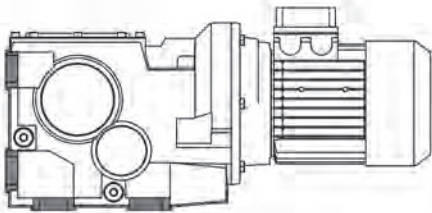
- Fissaggio piede / albero cavo.
- Foot mounting / hollow shaft.
- Fixation à pattes / arbre creux.
- Fußbefestigung / Hohlwelle.
- Fijación por patas / eje hueco.
- 底脚安装/空心轴。

B ... FD

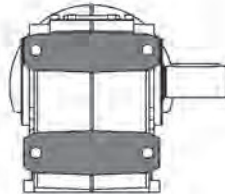
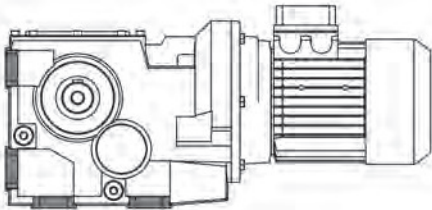
- Fissaggio piede / albero pieno D.
- Foot mounting / D solid shaft.
- Fixation à pattes / arbre en D.
- Fußbefestigung / D Vollwelle.
- Fijación por patas / eje macizo D.
- 底脚安装/D 实心轴。

B ... FS

- Fissaggio piede / albero pieno S.
- Foot mounting / S solid shaft.
- Fixation à pattes / arbre en S.
- Fußbefestigung / S Vollwelle.
- Fijación por patas / eje macizo S.
- 底脚安装/S 实心轴。

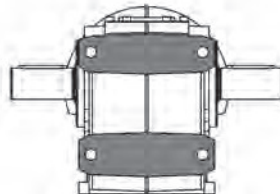
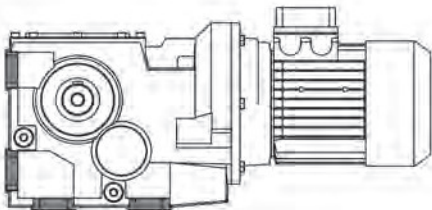
B ... FP

- Fissaggio piede / albero doppio.
- Foot mounting / double output shaft.
- Fixation à pattes / arbre double.
- Fußbefestigung / doppelte Abtriebswelle.
- Fijación por patas / eje doble.
- 底脚-安装/双输出轴

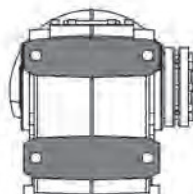
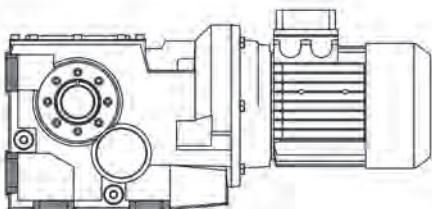
B ... FL

- Fissaggio piede / albero calettatore.
- Foot mounting / shrink disc shaft.
- Fixation à pattes / arbre avec frette.
- Fußbefestigung / Schrumpfscheibe.
- Fijación por patas / eje hueco con aro de apriete.
- 底脚安装/锁紧盘轴。

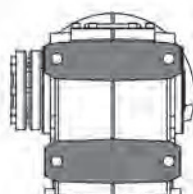
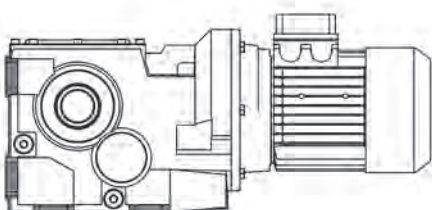
B ... FM

- Fissaggio piede / albero calettatore.
- Foot mounting / shrink disc shaft.
- Fixation à pattes / arbre avec frette.
- Fußbefestigung / Schrumpfscheibe.
- Fijación por patas / eje hueco con aro de apriete.
- 底脚安装/锁紧盘轴。

Versioni / Versions / Versions /
Ausführungen / Versiones / 版本

063 - 083 - 103 - 123

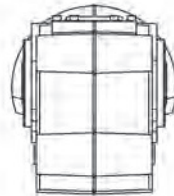
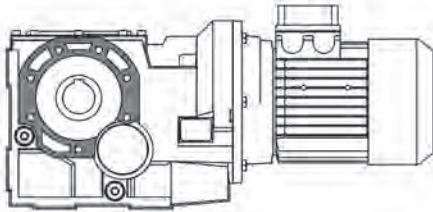

B ... SC

- Fissaggio flangia / albero cavo.
- Flange mounting / hollow shaft.
- Fixation à bride / arbre creux.
- Flanschbefestigung / Hohlwelle.
- Fijación por brida / eje hueco.
- 法兰安装/空心轴.

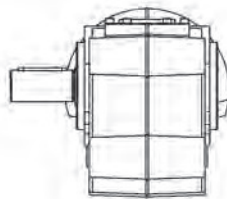
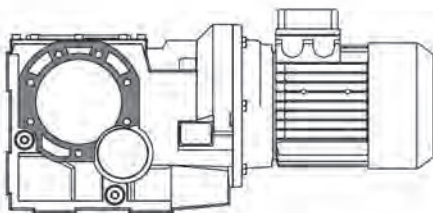

B ... SD

- Fissaggio flangia / albero pieno D.
- Flange mounting / D solid shaft.
- Fixation à bride / arbre en D.
- Flanschbefestigung / D Vollwelle.
- Fijación por brida / eje macizo D.
- 法兰安装/D 实心轴.

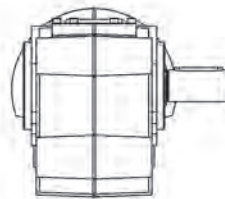
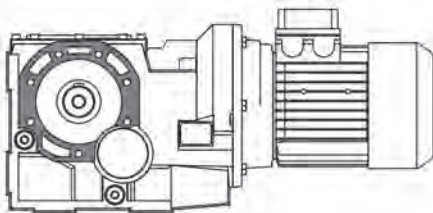

B ... SS

- Fissaggio flangia / albero pieno S.
- Flange mounting / S solid shaft.
- Fixation à bride / arbre en S.
- Flanschbefestigung / S Vollwelle.
- Fijación por brida / eje macizo S.
- 法兰安装/S 实心轴.

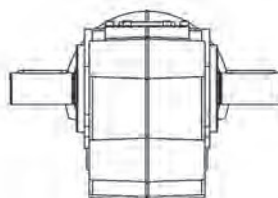
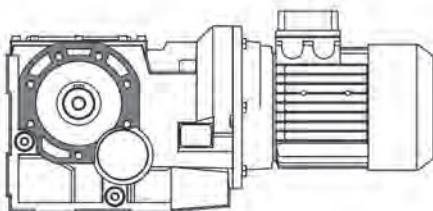

B ... SP

- Fissaggio flangia / albero doppio.
- Flange mounting / double output shaft.
- Fixation à bride / arbre double.
- Fußbefestigung / doppelte Abtriebswelle.
- Fijación por brida / eje doble.
- 法兰安装/双输出轴

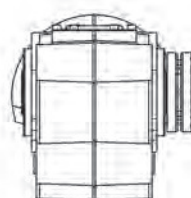
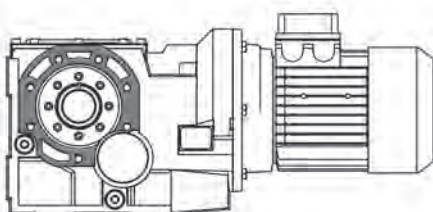

B ... SL

- Fissaggio flangia / albero calettatore.
- Flange mounting / shrink disc shaft.
- Fixation à bride / arbre avec frette.
- Flanschbefestigung / Schrumpfscheibe.
- Fijación por brida / eje hueco con aro de apriete.
- 法兰安装/锁紧盘轴.

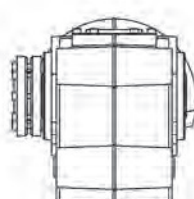
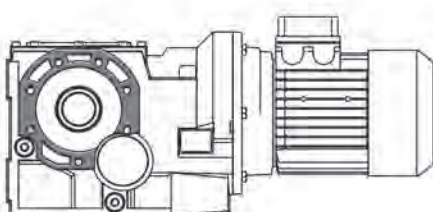

B ... SM

- Fissaggio flangia / albero calettatore.
- Flange mounting / shrink disc shaft.
- Fixation à bride / arbre avec frette.
- Flanschbefestigung / Schrumpfscheibe.
- Fijación por brida / eje hueco con aro de apriete.
- 法兰安装/锁紧盘轴.

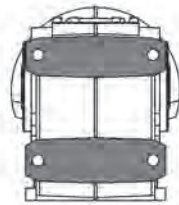
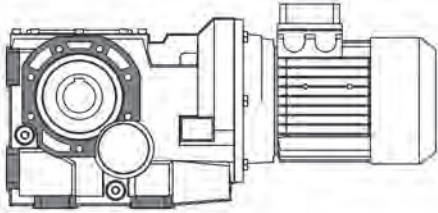
**Versioni / Versions / Versions /
Ausführungen / Versiones / 版本**
063 - 083 - 103 - 123 - 143 - 153 - 163

B ... UC

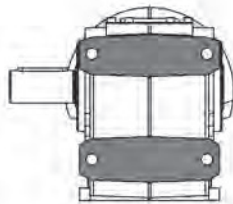
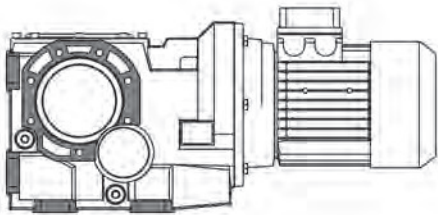
- Fissaggio piede-flangia / albero cavo.
- Foot-flange mounting / hollow shaft.
- Fixation à pattes et bride / arbre creux.
- Fuß-Flanschbefestigung / Hohlwelle.
- Fijación patas-bridá / eje hueco.
- 底脚-法兰安装/空心轴.

B ... UD

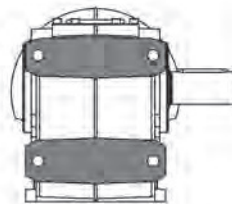
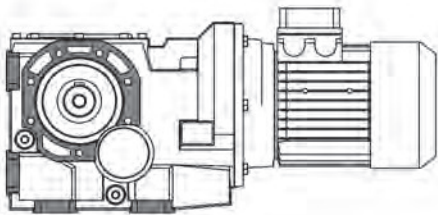
- Fissaggio piede-flangia / albero pieno D.
- Foot-flange mounting / D solid shaft.
- Fixation à pattes et bride / arbre en D.
- Fuß-Flanschbefestigung / D Vollwelle.
- Fijación patas-bridá / eje macizo D.
- 底脚-法兰安装/D 实心轴.

B ... US

- Fissaggio piede-flangia / albero pieno S.
- Foot-flange mounting / S solid shaft.
- Fixation à pattes et bride / arbre en S.
- Fuß-Flanschbefestigung / S Vollwelle.
- Fijación patas-bridá / eje macizo S.
- 底脚-法兰安装/S 实心轴.

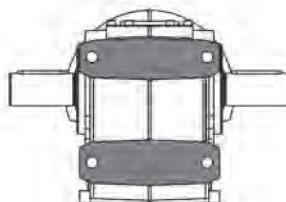
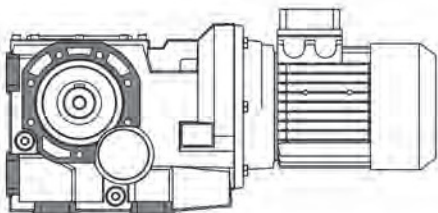
B ... UP

- Fissaggio piede-flangia / albero doppio.
- Foot-flange mounting / double output shaft.
- Fixation à pattes / bride arbre double.
- Fuß-Flanschbefestigung / doppelte Abtriebswelle.
- Fijación patas-bridá / eje doble.
- 底脚-法兰安装/双输出轴

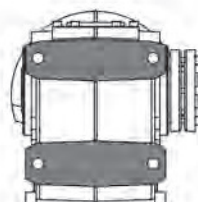
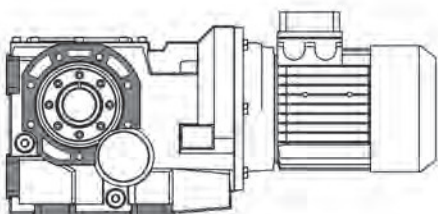

B ... UL

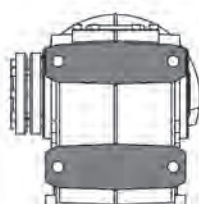
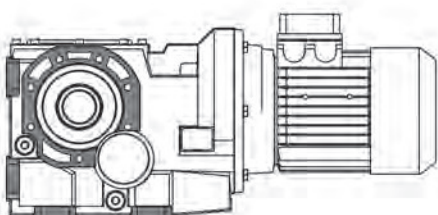
- Fissaggio piede-flangia / albero calettatore.
- Foot-flange mounting / shrink disc shaft.
- Fixation à pattes / bride arbre avec frette.
- Fuß-Flanschbefestigung / Schrumpfscheibe.
- Fijación patas-bridá / eje hueco con aro de apriete.
- 底脚-法兰安装/锁紧盘轴.

B ... UM

- Fissaggio piede-flangia / albero calettatore.
- Foot-flange mounting / shrink disc shaft.
- Fixation à pattes et bride / arbre avec frette.
- Fuß-Flanschbefestigung / Schrumpfscheibe.
- Fijación patas-bridá / eje hueco con aro de apriete.
- 底脚-法兰安装/锁紧盘轴.

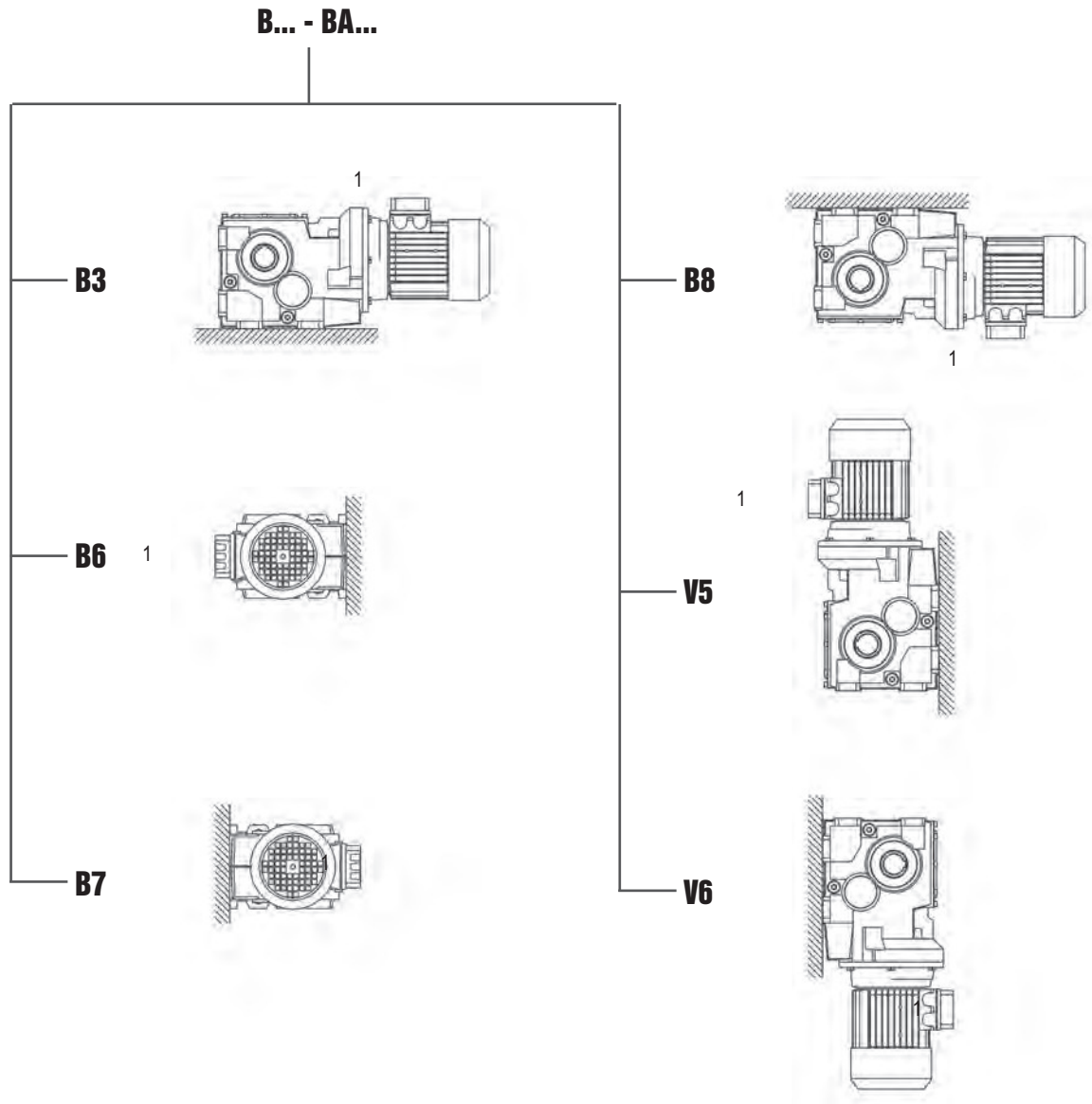
Piazzamento / Mounting positions / Pos. de montage /
Einbaulage / Pos. de montaje / 安装位置





- Per le posizioni di piazzamento verticali verificare quanto detto a pag. 6.
- For vertical positions, check with pages 6.
- Pour les positions de montage verticales, voir pages 6.
- Für die vertikalen Einbaulagen siehe Seite 6.
- Para las posiciones de montaje verticales, ver las páginas 6.
- 对于垂直位置，应该检查第 6. 页。



- Se non diversamente specificato le posizioni standard sono B3/B5.
- Unless specified otherwise, the standard positions are B3/B5.
- Si non spécifié, les positions standard sont B3/B5.
- Falls nicht anders angegeben, sind B3/B5 die Standardeinbaulagen.
- Si no se especifica lo contrario las posiciones estándar son B3/B5.
- 除非另有其它规定，B3/B5 是标准位置。

- Per le posizioni di piazzamento non previste occorre rivolgersi al ns. Servizio tecnico.
- For positions not envisaged, it is necessary to call our Technical Service.
- Pour les positions de montage non prévues, contacter notre S.c.e technique.
- Für nicht angegebene Einbaulagen setzen Sie sich bitte mit unserem Kundendienst in Verbindung.
- Para posiciones de montaje no previstas es necesario contactar con nuestro Servicio Técnico.
- 对于未列之位置，必须联系我们的服务技术部门。



**B/BA - Prestazioni / Performance / Performances /
Leistungen / Prestaciones / 性能**
0,12 kW

n2 [1/min]	M2 [Nm]	f.s.	i			Fr2 (a) [N]	Fr2 (b) [N]
183,8	6	15,2	7,62	BA42	63A4	-	1814
131,8	8	10,9	10,62	BA42	63A4	-	2027
108,1	10	8,9	12,95	BA42	63A4	-	2165
96,8	11	8,0	14,46	BA42	63A4	-	2246
85,0	13	9,4	16,47	BA42	63A4	-	2346
60,9	18	6,7	22,97	BA42	63A4	-	2621
50,0	22	5,5	28,00	BA42	63A4	-	2800
44,8	24	4,9	31,27	BA42	63A4	-	2905
41,4	26	4,6	33,78	BA42	63A4	-	2981
29,7	37	3,3	47,12	BA42	63A4	-	3331
24,4	45	2,7	57,43	BA42	63A4	-	3558
21,8	50	2,2	64,13	BA42	63A4	-	3691
17,9	61	1,8	78,17	BA42	63A4	-	3943
15,7	69	1,7	57,43	BA42	63B6	-	4000
14,0	78	1,4	64,13	BA42	63B6	-	4000
11,5	95	1,2	78,17	BA42	63B6	-	4000
10,3	101	2,2	136,53	BA53	63A4	-	4000
8,1	127	1,7	172,53	BA53	63A4	-	4000
7,1	145	1,5	197,11	BA53	63A4	-	4000
5,6	184	1,2	249,08	BA53	63A4	-	4000
5,2	200	1,1	271,16	BA53	63A4	-	4000
4,1	252	0,9	342,65	BA53	63A4	-	4000
4,3	237	1,9	321,85	BA73	63A4	10000	5500
3,9	264	1,7	357,95	BA73	63A4	10000	5500
3,2	326	1,4	442,76	BA73	63A4	10000	5500
20,2	51	11,8	69,16	B063	63A4	12000	8354
18,1	57	10,5	77,48	B063	63A4	12000	8658
15,5	67	9,0	90,33	B063	63A4	12000	9067
13,8	75	8,0	101,20	B063	63A4	12000	9392
12,5	82	7,3	111,74	B063	63A4	12000	9677
11,3	91	6,6	124,20	B063	63A4	12000	9977
10,1	103	5,9	139,15	B063	63A4	12000	10328
8,9	116	5,2	157,42	B063	63A4	12000	10708



0,18 kW

n2 [1/min]	M2 [Nm]	f.s.	i			Fr2 (a) [N]	Fr2 (b) [N]
183,8	9	10,1	7,62	BA42	63B4	-	1814
131,8	12	7,3	10,62	BA42	63B4	-	2027
108,1	15	6,0	12,95	BA42	63B4	-	2165
96,8	17	5,3	14,46	BA42	63B4	-	2246
85,0	19	6,2	16,47	BA42	63B4	-	2346
60,9	27	4,5	22,97	BA42	63B4	-	2621
50,0	33	3,7	28,00	BA42	63B4	-	2800
44,8	36	3,3	31,27	BA42	63B4	-	2905
41,4	39	3,0	33,78	BA42	63B4	-	2981
29,7	55	2,2	47,12	BA42	63B4	-	3331
24,4	67	1,8	57,43	BA42	63B4	-	3558
21,8	75	1,5	64,13	BA42	63B4	-	3691
17,9	91	1,2	78,17	BA42	63B4	-	3943
14,0	116	0,9	64,13	BA42	71A6	-	4000
11,5	142	0,8	78,17	BA42	71A6	-	4000



0,18 kW

n2 [1/min]	M2 [Nm]	f.s.	i			Fr2 (a) [N]	Fr2 (b) [N]
15,0	103	2,1	93,33	BA53	63B4	-	4000
12,5	123	1,8	111,61	BA53	63B4	-	4000
10,3	151	1,5	136,53	BA53	63B4	-	4000
8,1	191	1,2	172,53	BA53	63B4	-	4000
7,1	218	1,0	197,11	BA53	63B4	-	4000
5,6	275	0,8	249,08	BA53	63B4	-	4000
5,4	288	1,6	260,20	BA73	63B4	10000	5500
4,3	356	1,3	321,85	BA73	63B4	10000	5500
3,9	396	1,1	357,95	BA73	63B4	10000	5500
3,2	489	0,9	442,76	BA73	63B4	10000	5500
20,2	76	7,9	69,16	B063	63B4	12000	8201
18,1	86	7,0	77,48	B063	63B4	12000	8489
15,5	100	6,0	90,33	B063	63B4	12000	8867
13,8	112	5,4	101,20	B063	63B4	12000	9172
12,5	123	4,9	111,74	B063	63B4	12000	9433
11,3	137	4,4	124,20	B063	63B4	12000	9701
10,1	154	3,9	139,15	B063	63B4	12000	10025
8,9	174	3,4	157,42	B063	63B4	12000	10365



0,22 kW

n2 [1/min]	M2 [Nm]	f.s.	i			Fr2 (a) [N]	Fr2 (b) [N]
183,8	11	8,3	7,62	BA42	63C4	-	1814
131,8	15	5,9	10,62	BA42	63C4	-	2027
108,1	18	4,9	12,95	BA42	63C4	-	2165
96,8	21	4,4	14,46	BA42	63C4	-	2246
85,0	23	5,1	16,47	BA42	63C4	-	2346
60,9	33	3,7	22,97	BA42	63C4	-	2621
50,0	40	3,0	28,00	BA42	63C4	-	2800
44,8	45	2,7	31,27	BA42	63C4	-	2905
41,4	48	2,5	33,78	BA42	63C4	-	2981
29,7	67	1,8	47,12	BA42	63C4	-	3331
24,4	82	1,5	57,43	BA42	63C4	-	3558
21,8	91	1,2	64,13	BA42	63C4	-	3691
17,9	111	1,0	78,17	BA42	63C4	-	3943
21,6	92	2,2	64,87	BA52	63C4	-	3970
17,7	113	1,8	79,07	BA52	63C4	-	4000
19,0	100	2,2	73,70	BA53	63C4	-	4000
15,0	126	1,7	93,33	BA53	63C4	-	4000
12,5	151	1,5	111,61	BA53	63C4	-	4000
10,3	184	1,2	136,53	BA53	63C4	-	4000
8,1	233	0,9	172,53	BA53	63C4	-	4000
20,2	93	6,4	69,16	B063	63C4	12000	8099
18,1	105	5,7	77,48	B063	63C4	12000	8377
15,5	122	4,9	90,33	B063	63C4	12000	8733
13,8	137	4,4	101,20	B063	63C4	12000	9025
12,5	151	4,0	111,74	B063	63C4	12000	9271
11,3	168	3,6	124,20	B063	63C4	12000	9518
10,1	188	3,2	139,15	B063	63C4	12000	9823
8,9	213	2,8	157,42	B063	63C4	12000	10136



0,25 kW

n2 [1/min]	M2 [Nm]	f.s.	i			Fr2 (a) [N]	Fr2 (b) [N]
183,8	12	7,3	7,62	BA42	71A4	-	1814
131,8	17	5,2	10,62	BA42	71A4	-	2027
108,1	21	4,3	12,95	BA42	71A4	-	2165
96,8	23	3,8	14,46	BA42	71A4	-	2246
85,0	27	4,5	16,47	BA42	71A4	-	2346
60,9	37	3,2	22,97	BA42	71A4	-	2621
50,0	45	2,6	28,00	BA42	71A4	-	2800
44,8	51	2,4	31,27	BA42	71A4	-	2905
41,4	55	2,2	33,78	BA42	71A4	-	2981
29,7	76	1,6	47,12	BA42	71A4	-	3331
24,4	93	1,3	57,43	BA42	71A4	-	3558
21,8	104	1,1	64,13	BA42	71A4	-	3691
17,9	127	0,9	78,17	BA42	71A4	-	3943
19,1	119	1,0	47,12	BA42	71B6	-	3859
15,7	145	0,8	57,43	BA42	71B6	-	4000
21,6	105	1,9	64,87	BA52	71A4	-	3970
17,7	128	1,6	79,07	BA52	71A4	-	4000
19,0	113	1,9	73,70	BA53	71A4	-	4000
15,0	143	1,5	93,33	BA53	71A4	-	4000
12,5	171	1,3	111,61	BA53	71A4	-	4000
10,3	210	1,0	136,53	BA53	71A4	-	4000
8,1	265	0,8	172,53	BA53	71A4	-	4000
7,8	277	1,6	180,23	BA73	71A4	10000	5500
6,3	342	1,3	222,93	BA73	71A4	10000	5500
5,4	399	1,1	260,20	BA73	71A4	10000	5500
4,3	494	0,9	321,85	BA73	71A4	10000	5500
191,2	11	31,1	7,32	B063	71A4	10026	4023
106,5	20	29,2	13,15	B063	71A4	11924	4861
92,3	23	25,3	15,18	B063	71A4	12000	5084
82,3	26	23,0	17,00	B063	71A4	12000	5272
62,5	34	17,5	22,39	B063	71A4	12000	5744
41,9	51	11,7	33,43	B063	71A4	12000	6494
36,3	59	10,1	38,58	B063	71A4	12000	6773
32,4	66	9,0	43,22	B063	71A4	12000	7013
27,6	78	7,7	50,81	B063	71A4	12000	7346
24,6	87	6,9	56,93	B063	71A4	12000	7601
20,2	106	5,7	69,16	B063	71A4	12000	8022
18,1	119	5,0	77,48	B063	71A4	12000	8293
15,5	139	4,3	90,33	B063	71A4	12000	8633
13,8	155	3,9	101,20	B063	71A4	12000	8915
12,5	172	3,5	111,74	B063	71A4	12000	9149
11,3	191	3,1	124,20	B063	71A4	12000	9380
10,1	214	2,8	139,15	B063	71A4	12000	9672
8,9	242	2,5	157,42	B063	71A4	12000	9965



0,37 kW

n2 [1/min]	M2 [Nm]	f.s.	i			Fr2 (a) [N]	Fr2 (b) [N]
183,8	18	4,9	7,62	BA42	71B4	-	1814
131,8	25	3,5	10,62	BA42	71B4	-	2027
108,1	31	2,9	12,95	BA42	71B4	-	2165
96,8	35	2,6	14,46	BA42	71B4	-	2246
85,0	39	3,0	16,47	BA42	71B4	-	2346
60,9	55	2,2	22,97	BA42	71B4	-	2621
50,0	67	1,8	28,00	BA42	71B4	-	2800
44,8	75	1,6	31,27	BA42	71B4	-	2905



0,37 kW

n2 [1/min]	M2 [Nm]	f.s.	i			Fr2 (a) [N]	Fr2 (b) [N]
41,4	81	1,5	33,78	BA42	71B4	-	2981
29,7	113	1,1	47,12	BA42	71B4	-	3331
24,4	138	0,9	57,43	BA42	71B4	-	3558
33,4	101	2,0	41,97	BA52	71B4	-	3433
27,3	123	1,8	51,34	BA52	71B4	-	3672
21,6	156	1,3	64,87	BA52	71B4	-	3970
17,7	190	1,1	79,07	BA52	71B4	-	4000
19,0	167	1,3	73,70	BA53	71B4	-	4000
15,0	212	1,0	93,33	BA53	71B4	-	4000
12,5	254	0,9	111,61	BA53	71B4	-	4000
11,6	273	1,6	120,34	BA73	71B4	10000	5500
9,4	340	1,3	149,73	BA73	71B4	10000	5500
7,8	409	1,1	180,23	BA73	71B4	10000	5500
6,3	506	0,9	222,93	BA73	71B4	10000	5500
191,2	17	21,0	7,32	B063	71B4	9994	3987
106,5	30	19,7	13,15	B063	71B4	11873	4804
92,3	34	17,1	15,18	B063	71B4	12000	5017
82,3	39	15,5	17,00	B063	71B4	12000	5198
62,5	51	11,8	22,39	B063	71B4	12000	5647
41,9	76	7,9	33,43	B063	71B4	12000	6349
36,3	88	6,8	38,58	B063	71B4	12000	6602
32,4	98	6,1	43,22	B063	71B4	12000	6825
27,6	115	5,2	50,81	B063	71B4	12000	7120
24,6	129	4,6	56,93	B063	71B4	12000	7353
20,2	157	3,8	69,16	B063	71B4	12000	7715
18,1	176	3,4	77,48	B063	71B4	12000	7955
15,5	205	2,9	90,33	B063	71B4	12000	8232
13,8	230	2,6	101,20	B063	71B4	12000	8474
12,5	254	2,4	111,74	B063	71B4	12000	8663
11,3	282	2,1	124,20	B063	71B4	12000	8829
10,1	316	1,9	139,15	B063	71B4	12000	9066
8,9	358	1,7	157,42	B063	71B4	12000	9279



0,55 kW

n2 [1/min]	M2 [Nm]	f.s.	i			Fr2 (a) [N]	Fr2 (b) [N]
183,8	27	3,3	7,62	BA42	80A4	-	1814
131,8	38	2,4	10,62	BA42	80A4	-	2027
108,1	46	2,0	12,95	BA42	80A4	-	2165
96,8	52	1,7	14,46	BA42	80A4	-	2246
85,0	59	2,0	16,47	BA42	80A4	-	2346
60,9	82	1,5	22,97	BA42	80A4	-	2621
50,0	100	1,2	28,00	BA42	80A4	-	2800
44,8	111	1,1	31,27	BA42	80A4	-	2905
41,4	120	1,0	33,78	BA42	80A4	-	2981
68,4	73	2,7	20,46	BA52	80A4	-	2702
55,9	89	2,2	25,03	BA52	80A4	-	2890
44,3	113	1,8	31,63	BA52	80A4	-	3124
39,9	125	1,6	35,10	BA52	80A4	-	3235
33,4	150	1,3	41,97	BA52	80A4	-	3433
27,3	183	1,2	51,34	BA52	80A4	-	3672
21,6	231	0,9	64,87	BA52	80A4	-	3970
21,4	221	2,0	65,35	BA73	80A4	10000	5041
17,3	273	1,6	80,83	BA73	80A4	10000	5411
14,4	329	1,4	97,29	BA73	80A4	10000	5500
11,6	406	1,1	120,34	BA73	80A4	10000	5500



0,55 kW

n2 [1/min]	M2 [Nm]	f.s.	i			Fr2 (a) [N]	Fr2 (b) [N]
9,4	506	0,9	149,73	BA73	80A4	10000	5500
245,0	19	15,0	5,71	B063	80A4	9255	3645
203,5	23	14,6	6,88	B063	80A4	9767	3859
191,2	25	14,2	7,32	B063	80A4	9946	3934
152,8	31	14,9	9,16	B063	80A4	10627	4229
136,4	35	15,0	10,26	B063	80A4	10985	4381
127,0	37	14,5	11,03	B063	80A4	11211	4472
113,3	42	13,9	12,35	B063	80A4	11586	4631
106,5	44	13,3	13,15	B063	80A4	11796	4718
92,3	51	11,5	15,18	B063	80A4	12000	4916
82,3	57	10,5	17,00	B063	80A4	12000	5086
62,5	76	7,9	22,39	B063	80A4	12000	5501
53,7	88	6,8	26,09	B063	80A4	12000	5738
49,9	95	6,3	28,03	B063	80A4	12000	5840
41,9	113	5,3	33,43	B063	80A4	12000	6130
36,3	130	4,6	38,58	B063	80A4	12000	6345
32,4	146	4,1	43,22	B063	80A4	12000	6542
27,6	172	3,5	50,81	B063	80A4	12000	6782
24,6	192	3,1	56,93	B063	80A4	12000	6981
20,2	234	2,6	69,16	B063	80A4	12000	7255
18,1	262	2,3	77,48	B063	80A4	12000	7449
15,5	305	2,0	90,33	B063	80A4	12000	7631
12,0	393	2,2	116,25	B083	80A4	18000	9300
11,0	428	2,0	126,76	B083	80A4	18000	9541
9,7	489	1,7	144,77	B083	80A4	18000	9920



0,75 kW

n2 [1/min]	M2 [Nm]	f.s.	i			Fr2 (a) [N]	Fr2 (b) [N]
127,0	51	10,6	11,03	B063	80B4	11137	4391
113,3	57	10,2	12,35	B063	80B4	11506	4542
106,5	61	9,7	13,15	B063	80B4	11710	4623
92,3	70	8,4	15,18	B063	80B4	12000	4803
82,3	78	7,7	17,00	B063	80B4	12000	4963
62,5	103	5,8	22,39	B063	80B4	12000	5338
53,7	120	5,0	26,09	B063	80B4	12000	5548
49,9	129	4,6	28,03	B063	80B4	12000	5633
41,9	154	3,9	33,43	B063	80B4	12000	5887
36,3	178	3,4	38,58	B063	80B4	12000	6060
32,4	199	3,0	43,22	B063	80B4	12000	6228
27,6	234	2,6	50,81	B063	80B4	12000	6406
24,6	262	2,3	56,93	B063	80B4	12000	6567
20,2	318	1,9	69,16	B063	80B4	12000	6744
18,1	357	1,7	77,48	B063	80B4	12000	6886
15,5	416	1,4	90,33	B063	80B4	12000	6963
15,2	424	2,0	92,19	B083	80B4	18000	8544
13,9	463	1,8	100,57	B083	80B4	18000	8763
13,3	485	1,8	105,29	B083	80B4	18000	8879
12,0	535	1,6	116,25	B083	80B4	18000	9135
11,0	584	1,5	126,76	B083	80B4	18000	9361
9,7	667	1,3	144,77	B083	80B4	18000	9715



0,92 kW

n2 [1/min]	M2 [Nm]	f.s.	i			Fr2 (a) [N]	Fr2 (b) [N]
183,8	45	2,0	7,62	BA42	80C4	-	1814
131,8	63	1,4	10,62	BA42	80C4	-	2027
108,1	77	1,2	12,95	BA42	80C4	-	2165
96,8	86	1,0	14,46	BA42	80C4	-	2246
85,0	98	1,2	16,47	BA42	80C4	-	2346
60,9	137	0,9	22,97	BA42	80C4	-	2621
176,9	47	3,4	7,91	BA52	80C4	-	1969
148,0	56	2,8	9,46	BA52	80C4	-	2090
121,0	69	2,3	11,57	BA52	80C4	-	2235
95,7	87	1,8	14,63	BA52	80C4	-	2416
81,8	102	2,0	17,11	BA52	80C4	-	2546
68,4	122	1,6	20,46	BA52	80C4	-	2702
55,9	149	1,3	25,03	BA52	80C4	-	2890
44,3	189	1,1	31,63	BA52	80C4	-	3124
39,9	209	1,0	35,10	BA52	80C4	-	3235
33,4	250	0,8	41,97	BA52	80C4	-	3433
42,4	197	2,1	33,04	BA72	80C4	8031	4016
34,3	244	1,6	40,87	BA72	80C4	8621	4311
30,7	272	1,3	45,64	BA72	80C4	8944	4472
25,5	328	1,1	54,94	BA72	80C4	9515	4757
20,6	405	0,9	67,96	BA72	80C4	10000	5107
31,9	248	1,8	43,89	BA73	80C4	8828	4414
26,5	298	1,5	52,83	BA73	80C4	9391	4696
21,4	369	1,2	65,35	BA73	80C4	10000	5041
17,3	457	1,0	80,83	BA73	80C4	10000	5411
245,0	32	9,0	5,71	B063	80C4	9177	3558
203,5	39	8,8	6,88	B063	80C4	9674	3755
191,2	41	8,5	7,32	B063	80C4	9847	3823
152,8	52	8,9	9,16	B063	80C4	10514	4104
136,4	58	9,0	10,26	B063	80C4	10861	4243



0,75 kW

n2 [1/min]	M2 [Nm]	f.s.	i			Fr2 (a) [N]	Fr2 (b) [N]
183,8	37	2,4	7,62	BA42	80B4	-	1814
131,8	52	1,7	10,62	BA42	80B4	-	2027
108,1	63	1,4	12,95	BA42	80B4	-	2165
96,8	70	1,3	14,46	BA42	80B4	-	2246
85,0	80	1,5	16,47	BA42	80B4	-	2346
60,9	112	1,1	22,97	BA42	80B4	-	2621
50,0	136	0,9	28,00	BA42	80B4	-	2800
44,8	152	0,8	31,27	BA42	80B4	-	2905
81,8	83	2,4	17,11	BA52	80B4	-	2546
68,4	99	2,0	20,46	BA52	80B4	-	2702
55,9	122	1,6	25,03	BA52	80B4	-	2890
44,3	154	1,3	31,63	BA52	80B4	-	3124
39,9	171	1,2	35,10	BA52	80B4	-	3235
33,4	204	1,0	41,97	BA52	80B4	-	3433
27,3	250	0,9	51,34	BA52	80B4	-	3672
36,0	189	1,1	25,03	BA52	90S6	-	3349
28,5	239	0,8	31,63	BA52	90S6	-	3620
31,9	202	2,2	43,89	BA73	80B4	8828	4414
26,5	243	1,8	52,83	BA73	80B4	9391	4696
21,4	301	1,5	65,35	BA73	80B4	10000	5041
17,3	372	1,2	80,83	BA73	80B4	10000	5411
14,4	448	1,0	97,29	BA73	80B4	10000	5500
245,0	26	11,0	5,71	B063	80B4	9213	3598
203,5	32	10,7	6,88	B063	80B4	9717	3803
191,2	34	10,4	7,32	B063	80B4	9892	3874
152,8	42	10,9	9,16	B063	80B4	10566	4161
136,4	47	11,0	10,26	B063	80B4	10918	4306



0,92 kW

n2 [1/min]	M2 [Nm]	f.s.	i			Fr2 (a) [N]	Fr2 (b) [N]
127,0	62	8,7	11,03	B063	80C4	11075	4322
113,3	70	8,3	12,35	B063	80C4	11437	4465
106,5	74	7,9	13,15	B063	80C4	11637	4542
92,3	86	6,9	15,18	B063	80C4	12000	4708
82,3	96	6,2	17,00	B063	80C4	12000	4858
62,5	126	4,7	22,39	B063	80C4	12000	5200
53,7	147	4,1	26,09	B063	80C4	12000	5387
49,9	158	3,8	28,03	B063	80C4	12000	5456
41,9	189	3,2	33,43	B063	80C4	12000	5681
36,3	218	2,8	38,58	B063	80C4	12000	5818
32,4	244	2,5	43,22	B063	80C4	12000	5962
27,6	287	2,1	50,81	B063	80C4	12000	6087
24,6	322	1,9	56,93	B063	80C4	12000	6216
20,2	391	1,5	69,16	B063	80C4	12000	6309
18,1	438	1,4	77,48	B063	80C4	12000	6408
15,5	510	1,2	90,33	B063	80C4	12000	6395
17,3	456	1,9	80,76	B083	80C4	18000	8121
15,2	521	1,6	92,19	B083	80C4	18000	8433
13,9	568	1,5	100,57	B083	80C4	18000	8641
13,3	595	1,4	105,29	B083	80C4	18000	8752
12,0	657	1,3	116,25	B083	80C4	18000	8994
11,0	716	1,2	126,76	B083	80C4	18000	9208
9,7	818	1,0	144,77	B083	80C4	18000	9540
9,7	817	2,2	144,69	B103	80C4	22000	12015
8,5	933	1,9	165,25	B103	80C4	22000	12488



1,10 kW

n2 [1/min]	M2 [Nm]	f.s.	i			Fr2 (a) [N]	Fr2 (b) [N]
176,9	56	2,8	7,91	BA52	90S4	-	1969
148,0	67	2,4	9,46	BA52	90S4	-	2090
121,0	83	1,9	11,57	BA52	90S4	-	2235
95,7	104	1,5	14,63	BA52	90S4	-	2416
81,8	122	1,6	17,11	BA52	90S4	-	2546
68,4	146	1,4	20,46	BA52	90S4	-	2702
55,9	178	1,1	25,03	BA52	90S4	-	2890
44,3	225	0,9	31,63	BA52	90S4	-	3124
51,0	196	2,1	27,45	BA72	90S4	7550	3775
42,4	236	1,8	33,04	BA72	90S4	8031	4016
34,3	291	1,4	40,87	BA72	90S4	8621	4311
30,7	325	1,1	45,64	BA72	90S4	8944	4472
25,5	392	0,9	54,94	BA72	90S4	9515	4757
31,9	296	1,5	43,89	BA73	90S4	8828	4414
26,5	357	1,3	52,83	BA73	90S4	9391	4696
21,4	441	1,0	65,35	BA73	90S4	10000	5041
245,0	39	7,5	5,71	B063	90S4	9140	3516
203,5	46	7,3	6,88	B063	90S4	9629	3705
191,2	49	7,1	7,32	B063	90S4	9798	3769
152,8	62	7,4	9,16	B063	90S4	10460	4043
136,4	69	7,5	10,26	B063	90S4	10801	4176
127,0	74	7,3	11,03	B063	90S4	11009	4248
113,3	83	7,0	12,35	B063	90S4	11364	4385
106,5	89	6,6	13,15	B063	90S4	11559	4456
92,3	102	5,8	15,18	B063	90S4	12000	4607
82,3	115	5,2	17,00	B063	90S4	12000	4747
62,5	151	4,0	22,39	B063	90S4	12000	5053



1,10 kW

n2 [1/min]	M2 [Nm]	f.s.	i			Fr2 (a) [N]	Fr2 (b) [N]
53,7	176	3,4	26,09	B063	90S4	12000	5217
49,9	189	3,2	28,03	B063	90S4	12000	5270
41,9	226	2,7	33,43	B063	90S4	12000	5463
36,3	261	2,3	38,58	B063	90S4	12000	5561
32,4	292	2,1	43,22	B063	90S4	12000	5679
27,6	343	1,7	50,81	B063	90S4	12000	5749
24,6	384	1,6	56,93	B063	90S4	12000	5844
27,4	346	2,5	51,19	B083	90S4	18000	7041
25,2	375	2,3	55,52	B083	90S4	18000	7209
23,4	405	2,1	59,96	B083	90S4	18000	7371
22,0	430	2,0	63,74	B083	90S4	18000	7501
20,2	467	1,8	69,14	B083	90S4	18000	7677
19,1	494	1,7	73,14	B083	90S4	18000	7799
17,3	545	1,6	80,76	B083	90S4	18000	8018
15,2	623	1,4	92,19	B083	90S4	18000	8315
13,9	679	1,3	100,57	B083	90S4	18000	8513
13,3	711	1,2	105,29	B083	90S4	18000	8618
12,0	785	1,1	116,25	B083	90S4	18000	8846
11,0	856	1,0	126,76	B083	90S4	18000	9046
9,7	978	0,9	144,77	B083	90S4	18000	9355
13,3	712	2,5	105,44	B103	90S4	22000	10843
12,2	775	2,3	114,80	B103	90S4	22000	11117
11,6	813	2,2	120,42	B103	90S4	22000	11272
10,5	897	2,0	132,87	B103	90S4	22000	11597
9,7	977	1,8	144,69	B103	90S4	22000	11884
8,5	1116	1,6	165,25	B103	90S4	22000	12338



1,50 kW

n2 [1/min]	M2 [Nm]	f.s.	i			Fr2 (a) [N]	Fr2 (b) [N]
176,9	77	2,1	7,91	BA52	90L4	-	1969
148,0	92	1,7	9,46	BA52	90L4	-	2090
121,0	113	1,4	11,57	BA52	90L4	-	2235
95,7	142	1,1	14,63	BA52	90L4	-	2416
81,8	166	1,2	17,11	BA52	90L4	-	2546
68,4	199	1,0	20,46	BA52	90L4	-	2702
55,9	243	0,8	25,03	BA52	90L4	-	2890
63,1	216	1,9	22,19	BA72	90L4	7033	3517
51,0	267	1,6	27,45	BA72	90L4	7550	3775
42,4	321	1,3	33,04	BA72	90L4	8031	4016
34,3	397	1,0	40,87	BA72	90L4	8621	4311
31,9	404	1,1	43,89	BA73	90L4	8828	4414
26,5	487	0,9	52,83	BA73	90L4	9391	4696
245,0	53	5,5	5,71	B063	90L4	9056	3423
203,5	63	5,4	6,88	B063	90L4	9528	3593
191,2	67	5,2	7,32	B063	90L4	9691	3650
152,8	84	5,5	9,16	B063	90L4	10338	3907
136,4	95	5,5	10,26	B063	90L4	10666	4027
127,0	102	5,3	11,03	B063	90L4	10862	4085
113,3	114	5,1	12,35	B063	90L4	11203	4205
106,5	121	4,9	13,15	B063	90L4	11387	4265
92,3	140	4,2	15,18	B063	90L4	11802	4383
82,3	157	3,8	17,00	B063	90L4	12000	4500
62,5	206	2,9	22,39	B063	90L4	12000	4728
53,7	240	2,5	26,09	B063	90L4	12000	4838
49,9	258	2,3	28,03	B063	90L4	12000	4855



1,50 kW

n2 [1/min]	M2 [Nm]	f.s.	i			Fr2 (a) [N]	Fr2 (b) [N]
41,9	308	1,9	33,43	B063	90L4	12000	4977
36,3	355	1,7	38,58	B063	90L4	12000	4990
32,4	398	1,5	43,22	B063	90L4	12000	5052
27,6	468	1,3	50,81	B063	90L4	12000	4998
24,6	524	1,1	56,93	B063	90L4	12000	5018
35,4	365	2,3	39,60	B083	90L4	18000	6414
32,6	396	2,1	42,95	B083	90L4	18000	6565
30,8	418	2,0	45,44	B083	90L4	18000	6670
27,4	471	1,8	51,19	B083	90L4	18000	6895
25,2	511	1,7	55,52	B083	90L4	18000	7052
23,4	552	1,5	59,96	B083	90L4	18000	7201
22,0	587	1,4	63,74	B083	90L4	18000	7320
20,2	637	1,3	69,14	B083	90L4	18000	7480
19,1	674	1,3	73,14	B083	90L4	18000	7592
17,3	744	1,1	80,76	B083	90L4	18000	7789
15,2	849	1,0	92,19	B083	90L4	18000	8053
13,9	926	0,9	100,57	B083	90L4	18000	8227
13,3	970	0,9	105,29	B083	90L4	18000	8319
19,2	670	2,5	72,76	B103	90L4	22000	9561
17,7	727	2,3	78,90	B103	90L4	22000	9789
16,7	770	2,3	83,66	B103	90L4	22000	9955
15,2	850	2,1	92,31	B103	90L4	22000	10239
13,3	971	1,9	105,44	B103	90L4	22000	10631
12,2	1057	1,7	114,80	B103	90L4	22000	10885
11,6	1109	1,6	120,42	B103	90L4	22000	11029
10,5	1224	1,5	132,87	B103	90L4	22000	11329
9,7	1332	1,4	144,69	B103	90L4	22000	11592
8,5	1522	1,2	165,25	B103	90L4	22000	12005
7,8	1661	2,1	180,40	B123	90L4	30000	17180



1,84 kW

n2 [1/min]	M2 [Nm]	f.s.	i			Fr2 (a) [N]	Fr2 (b) [N]
176,9	94	1,7	7,91	BA52	90LL4	-	1969
148,0	113	1,4	9,46	BA52	90LL4	-	2090
121,0	138	1,2	11,57	BA52	90LL4	-	2235
95,7	174	0,9	14,63	BA52	90LL4	-	2416
81,8	204	1,0	17,11	BA52	90LL4	-	2546
68,4	244	0,8	20,46	BA52	90LL4	-	2702
78,0	214	2,0	17,94	BA72	90LL4	6552	3276
63,1	265	1,6	22,19	BA72	90LL4	7033	3517
51,0	327	1,3	27,45	BA72	90LL4	7550	3775
42,4	394	1,1	33,04	BA72	90LL4	8031	4016
245,0	65	4,5	5,71	B063	90LL4	8984	3344
203,5	78	4,4	6,88	B063	90LL4	9442	3497
191,2	83	4,2	7,32	B063	90LL4	9600	3549
152,8	103	4,4	9,16	B063	90LL4	10234	3792
136,4	116	4,5	10,26	B063	90LL4	10552	3900
127,0	125	4,3	11,03	B063	90LL4	10737	3947
113,3	140	4,2	12,35	B063	90LL4	11066	4053
106,5	149	4,0	13,15	B063	90LL4	11241	4102
92,3	171	3,4	15,18	B063	90LL4	11631	4192
82,3	192	3,1	17,00	B063	90LL4	11974	4290
62,5	253	2,4	22,39	B063	90LL4	12000	4452
53,7	295	2,0	26,09	B063	90LL4	12000	4516
49,9	317	1,9	28,03	B063	90LL4	12000	4503



1,84 kW

n2 [1/min]	M2 [Nm]	f.s.	i			Fr2 (a) [N]	Fr2 (b) [N]
41,9	378	1,6	33,43	B063	90LL4	12000	4565
36,3	436	1,4	38,58	B063	90LL4	12000	4505
32,4	488	1,2	43,22	B063	90LL4	12000	4518
27,6	574	1,0	50,81	B063	90LL4	12000	4359
24,6	643	0,9	56,93	B063	90LL4	12000	4315
44,0	359	2,4	31,80	B083	90LL4	18000	5943
35,4	447	1,9	39,60	B083	90LL4	18000	6319
32,6	485	1,8	42,95	B083	90LL4	18000	6461
30,8	513	1,7	45,44	B083	90LL4	18000	6560
27,4	578	1,5	51,19	B083	90LL4	18000	6772
25,2	627	1,4	55,52	B083	90LL4	18000	6918
23,4	677	1,3	59,96	B083	90LL4	18000	7056
22,0	720	1,2	63,74	B083	90LL4	18000	7167
20,2	781	1,1	69,14	B083	90LL4	18000	7314
19,1	826	1,0	73,14	B083	90LL4	18000	7415
17,3	912	0,9	80,76	B083	90LL4	18000	7594
21,6	733	2,3	64,89	B103	90LL4	22000	9134
20,4	775	2,2	68,58	B103	90LL4	22000	9279
19,2	822	2,1	72,76	B103	90LL4	22000	9436
17,7	892	1,9	78,92	B103	90LL4	22000	9654
16,7	945	1,9	83,66	B103	90LL4	22000	9812
15,2	1043	1,7	92,31	B103	90LL4	22000	10081
13,3	1191	1,5	105,44	B103	90LL4	22000	10450
12,2	1297	1,4	114,80	B103	90LL4	22000	10688
11,6	1360	1,3	120,42	B103	90LL4	22000	10823
10,5	1501	1,2	132,87	B103	90LL4	22000	11101
9,7	1634	1,1	144,69	B103	90LL4	22000	11344
8,5	1867	1,0	165,25	B103	90LL4	22000	11721
9,7	1631	2,1	144,43	B123	90LL4	30000	15849
8,7	1810	1,9	160,23	B123	90LL4	30000	16242
7,8	2038	1,7	180,40	B123	90LL4	30000	16686



2,20 kW

n2 [1/min]	M2 [Nm]	f.s.	i			Fr2 (a) [N]	Fr2 (b) [N]
78,0	256	1,6	17,94	BA72	100LA4	6552	3276
63,1	316	1,3	22,19	BA72	100LA4	7033	3517
51,0	391	1,1	27,45	BA72	100LA4	7550	3775
245,0	77	3,8	5,71	B063	100LA4	8909	3260
203,5	93	3,7	6,88	B063	100LA4	9351	3396
191,2	99	3,5	7,32	B063	100LA4	9503	3441
152,8	124	3,7	9,16	B063	100LA4	10124	3670
136,4	139	3,8	10,26	B063	100LA4	10432	3766
127,0	149	3,6	11,03	B063	100LA4	10605	3800
113,3	167	3,5	12,35	B063	100LA4	10921	3891
106,5	178	3,3	13,15	B063	100LA4	11087	3930
92,3	205	2,9	15,18	B063	100LA4	11449	3990
82,3	230	2,6	17,00	B063	100LA4	11774	4068
62,5	302	2,0	22,39	B063	100LA4	12000	4159
44,0	429	2,0	31,80	B083	100LA4	18000	5862
40,6	466	1,8	34,49	B083	100LA4	18000	5993
35,4	535	1,6	39,60	B083	100LA4	18000	6218
32,6	580	1,5	42,95	B083	100LA4	18000	6351
30,8	614	1,4	45,44	B083	100LA4	18000	6444
27,4	691	1,2	51,19	B083	100LA4	18000	6641
25,2	750	1,1	55,52	B083	100LA4	18000	6776



2,20 kW

n2 [1/min]	M2 [Nm]	f.s.	i			Fr2 (a) [N]	Fr2 (b) [N]
23,4	810	1,0	59,96	B083	100LA4	18000	6903
22,0	861	1,0	63,74	B083	100LA4	18000	7004
20,2	934	0,9	69,14	B083	100LA4	18000	7137
19,1	988	0,9	73,14	B083	100LA4	18000	7228
26,4	716	2,4	53,02	B103	100LA4	22000	8520
23,9	790	2,2	58,50	B103	100LA4	22000	8760
21,6	876	1,9	64,89	B103	100LA4	22000	9016
20,4	926	1,8	68,58	B103	100LA4	22000	9155
19,2	983	1,7	72,76	B103	100LA4	22000	9304
17,7	1066	1,6	78,92	B103	100LA4	22000	9511
16,7	1130	1,6	83,66	B103	100LA4	22000	9660
15,2	1247	1,4	92,31	B103	100LA4	22000	9913
13,3	1424	1,3	105,44	B103	100LA4	22000	10258
12,2	1551	1,2	114,80	B103	100LA4	22000	10480
11,6	1626	1,1	120,42	B103	100LA4	22000	10604
10,5	1795	1,0	132,87	B103	100LA4	22000	10860
11,7	1615	2,2	119,60	B123	100LA4	30000	14785
10,8	1755	2,0	129,96	B123	100LA4	30000	15071
9,7	1951	1,8	144,43	B123	100LA4	30000	15430
8,7	2164	1,6	160,23	B123	100LA4	30000	15777
7,8	2437	1,4	180,40	B123	100LA4	30000	16162
7,5	2529	2,0	187,24	B143	100LA4	45000	45000



3,00 kW

n2 [1/min]	M2 [Nm]	f.s.	i			Fr2 (a) [N]	Fr2 (b) [N]
112,5	242	1,4	12,44	BA72	100LB4	5800	2900
93,9	290	1,4	14,91	BA72	100LB4	6160	3080
78,0	349	1,2	17,94	BA72	100LB4	6552	3276
245,0	105	2,8	5,71	B063	100LB4	8741	3074
203,5	127	2,7	6,88	B063	100LB4	9149	3172
191,2	135	2,6	7,32	B063	100LB4	9288	3202
152,8	169	2,7	9,16	B063	100LB4	9881	3399
136,4	189	2,8	10,26	B063	100LB4	10164	3468
127,0	203	2,7	11,03	B063	100LB4	10312	3474
113,3	228	2,5	12,35	B063	100LB4	10598	3533
106,5	242	2,4	13,15	B063	100LB4	10743	3549
92,3	279	2,1	15,18	B063	100LB4	11045	3541
82,3	313	1,9	17,00	B063	100LB4	11329	3574
62,5	412	1,5	22,39	B063	100LB4	11920	3509
61,4	420	2,0	22,82	B083	100LB4	18000	5213
52,4	492	1,7	26,71	B083	100LB4	18000	5435
47,5	543	1,6	29,50	B083	100LB4	18000	5575
44,0	586	1,5	31,80	B083	100LB4	18000	5682
40,6	635	1,3	34,49	B083	100LB4	18000	5797
35,4	729	1,2	39,60	B083	100LB4	18000	5993
32,6	791	1,1	42,95	B083	100LB4	18000	6107
30,8	837	1,0	45,44	B083	100LB4	18000	6186
34,0	757	2,2	41,12	B103	100LB4	22000	7754
31,4	822	2,1	44,61	B103	100LB4	22000	7929
29,6	871	2,0	47,28	B103	100LB4	22000	8055
27,9	925	1,8	50,24	B103	100LB4	22000	8188
26,4	977	1,7	53,02	B103	100LB4	22000	8306
23,9	1078	1,6	58,50	B103	100LB4	22000	8524
21,6	1195	1,4	64,89	B103	100LB4	22000	8755
20,4	1263	1,3	68,58	B103	100LB4	22000	8878



3,00 kW

n2 [1/min]	M2 [Nm]	f.s.	i			Fr2 (a) [N]	Fr2 (b) [N]
19,2	1340	1,3	72,76	B103	100LB4	22000	9010
17,7	1454	1,2	78,92	B103	100LB4	22000	9192
16,7	1541	1,2	83,66	B103	100LB4	22000	9322
15,2	1700	1,1	92,31	B103	100LB4	22000	9541
14,0	1836	1,9	99,70	B123	100LB4	30000	13509
13,1	1964	1,8	106,65	B123	100LB4	30000	13699
11,7	2203	1,6	119,60	B123	100LB4	30000	14013
10,8	2394	1,5	129,96	B123	100LB4	30000	14233
9,7	2660	1,3	144,43	B123	100LB4	30000	14498
8,7	2951	1,2	160,23	B123	100LB4	30000	14743
7,8	3323	1,1	180,40	B123	100LB4	30000	14999
10,3	2513	2,0	136,44	B143	100LB4	45000	45000
9,4	2755	1,8	149,59	B143	100LB4	45000	45000
8,4	3067	1,6	166,53	B143	100LB4	45000	45000
7,5	3449	1,4	187,24	B143	100LB4	45000	45000



4,00 kW

n2 [1/min]	M2 [Nm]	f.s.	i			Fr2 (a) [N]	Fr2 (b) [N]
167,5	217	1,6	8,36	BA72	112M4	5079	2540
139,2	261	1,3	10,06	BA72	112M4	5403	2701
112,5	323	1,1	12,44	BA72	112M4	5800	2900
93,9	386	1,1	14,91	BA72	112M4	6160	3080
245,0	140	2,1	5,71	B063	112M4	8532	2841
203,5	169	2,0	6,88	B063	112M4	8897	2892
191,2	180	1,9	7,32	B063	112M4	9020	2904
152,8	225	2,0	9,16	B063	112M4	9576	3060
136,4	252	2,1	10,26	B063	112M4	9828	3095
127,0	271	2,0	11,03	B063	112M4	9945	3066
113,3	303	1,9	12,35	B063	112M4	10194	3084
106,5	323	1,8	13,15	B063	112M4	10314	3071
92,3	373	1,6	15,18	B063	112M4	10540	2980
82,3	418	1,4	17,00	B063	112M4	10774	2957
62,5	550	1,1	22,39	B063	112M4	11189	2696
84,4	408	2,1	16,60	B083	112M4	16308	4659
76,4	450	1,9	18,32	B083	112M4	16733	4781
61,4	560	1,5	22,82	B083	112M4	17680	5051
52,4	656	1,3	26,71	B083	112M4	18000	5245
47,5	724	1,2	29,50	B083	112M4	18000	5366
44,0	781	1,1	31,80	B083	112M4	18000	5456
40,6	847	1,0	34,49	B083	112M4	18000	5552
42,3	812	2,1	33,07	B103	112M4	22000	7127
39,0	881	1,9	35,87	B103	112M4	22000	7283
34,0	1010	1,7	41,12	B103	112M4	22000	7546
31,4	1095	1,6	44,61	B103	112M4	22000	7704
29,6	1161	1,5	47,28	B103	112M4	22000	7817
27,9	1234	1,4	50,24	B103	112M4	22000	7935
26,4	1302	1,3	53,02	B103	112M4	22000	8039
23,9	1437	1,2	58,50	B103	112M4	22000	8229
21,6	1593	1,1	64,89	B103	112M4	22000	8427
20,4	1684	1,0	68,58	B103	112M4	22000	8532
20,2	1705	1,9	69,43	B123	112M4	30000	11890
18,8	1827	1,9	74,42	B123	112M4	30000	12056
17,5	1966	1,8	80,04	B123	112M4	30000	12226
15,6	2207	1,6	89,87	B123	112M4	30000	12486
14,0	2448	1,4	99,70	B123	112M4	30000	12705



4,00 kW

n2 [1/min]	M2 [Nm]	f.s.	i			Fr2 (a) [N]	Fr2 (b) [N]
13,1	2619	1,3	106,65	B123	112M4	30000	12839
11,7	2937	1,2	119,60	B123	112M4	30000	13049
10,8	3191	1,1	129,96	B123	112M4	30000	13185
9,7	3547	1,0	144,43	B123	112M4	30000	13334
8,7	3935	0,9	160,23	B123	112M4	30000	13452
16,4	2101	2,4	85,54	B143	112M4	45000	45000
14,9	2311	2,2	94,13	B143	112M4	45000	45000
13,2	2599	1,9	105,83	B143	112M4	45000	45000
12,5	2749	1,8	111,94	B143	112M4	45000	45000
11,2	3060	1,6	124,62	B143	112M4	45000	45000
10,3	3351	1,5	136,44	B143	112M4	45000	45000
9,4	3674	1,4	149,59	B143	112M4	45000	45000
8,4	4090	1,2	166,53	B143	112M4	45000	45000
7,5	4598	1,1	187,24	B143	112M4	45000	45000



4,80 kW

n2 [1/min]	M2 [Nm]	f.s.	i			Fr2 (a) [N]	Fr2 (b) [N]
167,5	260	1,3	8,36	BA72	112MS4	5079	2540
139,2	313	1,1	10,06	BA72	112MS4	5403	2701
245,0	168	1,7	5,71	B063	112MS4	8364	2655
203,5	203	1,7	6,88	B063	112MS4	8695	2668
191,2	216	1,6	7,32	B063	112MS4	8805	2665
152,8	270	1,7	9,16	B063	112MS4	9332	2789
136,4	302	1,7	10,26	B063	112MS4	9560	2797
127,0	325	1,7	11,03	B063	112MS4	9652	2740
113,3	364	1,6	12,35	B063	112MS4	9871	2725
106,5	388	1,5	13,15	B063	112MS4	9970	2689
92,3	447	1,3	15,18	B063	112MS4	10137	2531
82,3	501	1,2	17,00	B063	112MS4	10330	2463
62,5	660	0,9	22,39	B063	112MS4	10604	2046
179,3	230	2,2	7,81	B083	112MS4	13071	3735
162,4	254	2,4	8,62	B083	112MS4	13440	3840
133,4	309	2,1	10,49	B083	112MS4	14185	4053
120,8	341	2,2	11,59	B083	112MS4	14568	4162
97,0	425	1,9	14,43	B083	112MS4	15427	4408
84,4	489	1,7	16,60	B083	112MS4	15978	4565
76,4	540	1,6	18,32	B083	112MS4	16369	4677
61,4	672	1,3	22,82	B083	112MS4	17226	4922
52,4	787	1,1	26,71	B083	112MS4	17827	5093
47,5	869	1,0	29,50	B083	112MS4	18000	5198
52,8	781	1,9	26,51	B103	112MS4	22000	6605
45,8	900	1,8	30,55	B103	112MS4	22000	6854
42,3	974	1,7	33,07	B103	112MS4	22000	6994
39,0	1057	1,6	35,87	B103	112MS4	22000	7138
34,0	1212	1,4	41,12	B103	112MS4	22000	7380
31,4	1315	1,3	44,61	B103	112MS4	22000	7524
29,6	1393	1,2	47,28	B103	112MS4	22000	7626
27,9	1481	1,1	50,24	B103	112MS4	22000	7732
26,4	1562	1,1	53,02	B103	112MS4	22000	7825
23,9	1724	1,0	58,50	B103	112MS4	22000	7993
25,8	1600	2,0	54,30	B123	112MS4	30000	10926
23,6	1749	1,8	59,36	B123	112MS4	30000	11119
22,4	1844	1,8	62,59	B123	112MS4	30000	11231
20,2	2046	1,6	69,43	B123	112MS4	30000	11442
18,8	2193	1,6	74,42	B123	112MS4	30000	11576



4,80 kW

n2 [1/min]	M2 [Nm]	f.s.	i			Fr2 (a) [N]	Fr2 (b) [N]
17,5	2359	1,5	80,04	B123	112MS4	30000	11710
15,6	2648	1,3	89,87	B123	112MS4	30000	11906
14,0	2938	1,2	99,70	B123	112MS4	30000	12062
13,1	3143	1,1	106,65	B123	112MS4	30000	12151
11,7	3524	1,0	119,60	B123	112MS4	30000	12277
10,8	3830	0,9	129,96	B123	112MS4	30000	12346
19,9	2076	2,4	70,43	B143	112MS4	44917	44917
18,2	2273	2,2	77,12	B143	112MS4	45000	45000
16,4	2521	2,0	85,54	B143	112MS4	45000	45000
14,9	2774	1,8	94,13	B143	112MS4	45000	45000
13,2	3119	1,6	105,83	B143	112MS4	45000	45000
12,5	3299	1,5	111,94	B143	112MS4	45000	45000
11,2	3672	1,4	124,62	B143	112MS4	45000	45000
10,3	4021	1,2	136,44	B143	112MS4	45000	45000
9,4	4408	1,1	149,59	B143	112MS4	45000	45000
8,4	4907	1,0	166,53	B143	112MS4	45000	45000
7,5	5518	0,9	187,24	B143	112MS4	45000	45000



5,50 kW

n2 [1/min]	M2 [Nm]	f.s.	i			Fr2 (a) [N]	Fr2 (b) [N]
179,3	264	1,9	7,81	B083	132S4	12936	3696
162,4	291	2,1	8,62	B083	132S4	13290	3797
133,4	354	1,8	10,49	B083	132S4	14003	4001
120,8	391	1,9	11,59	B083	132S4	14367	4105
97,0	487	1,7	14,43	B083	132S4	15176	4336
84,4	560	1,5	16,60	B083	132S4	15690	4483
76,4	619	1,4	18,32	B083	132S4	16051	4586
61,4	770	1,1	22,82	B083	132S4	16830	4808
52,4	902	0,9	26,71	B083	132S4	17362	4961
47,5	996	0,9	29,50	B083	132S4	17681	5052
73,5	643	2,2	19,06	B103	132S4	20894	5970
59,1	800	1,7	23,70	B103	132S4	22000	6326
52,8	895	1,7	26,51	B103	132S4	22000	6511
45,8	1032	1,6	30,55	B103	132S4	22000	6746
42,3	1117	1,5	33,07	B103	132S4	22000	6877
39,0	1211	1,4	35,87	B103	132S4	22000	7012
34,0	1389	1,2	41,12	B103	132S4	22000	7235
31,4	1506	1,1	44,61	B103	132S4	22000	7366
29,6	1597	1,1	47,28	B103	132S4	22000	7459
27,9	1696	1,0	50,24	B103	132S4	22000	7555
34,5	1369	2,0	40,53	B123	132S4	30000	10032
31,2	1516	2,0	44,89	B123	132S4	30000	10244
28,1	1682	1,9	49,80	B123	132S4	30000	10453
25,8	1833	1,7	54,30	B123	132S4	30000	10620
23,6	2004	1,6	59,36	B123	132S4	30000	10784
22,4	2113	1,6	62,59	B123	132S4	30000	10878
20,2	2344	1,4	69,43	B123	132S4	30000	11050
18,8	2513	1,4	74,42	B123	132S4	30000	11156
17,5	2703	1,3	80,04	B123	132S4	30000	11258
15,6	3034	1,2	89,87	B123	132S4	30000	11399
14,0	3366	1,0	99,70	B123	132S4	30000	11499
13,1	3601	1,0	106,65	B123	132S4	30000	11549
21,6	2191	2,3	64,88	B143	132S4	43103	43103
19,9	2378	2,1	70,43	B143	132S4	43830	43830
18,2	2604	1,9	77,12	B143	132S4	44611	44611



5,50 kW

n2 [1/min]	M2 [Nm]	f.s.	i			Fr2 (a) [N]	Fr2 (b) [N]
16,4	2888	1,7	85,54	B143	132S4	45000	45000
14,9	3178	1,6	94,13	B143	132S4	45000	45000
13,2	3573	1,4	105,83	B143	132S4	45000	45000
12,5	3780	1,3	111,94	B143	132S4	45000	45000
11,2	4208	1,2	124,62	B143	132S4	45000	45000
10,3	4607	1,1	136,44	B143	132S4	45000	45000
9,4	5051	1,0	149,59	B143	132S4	45000	45000
8,4	5623	0,9	166,53	B143	132S4	45000	45000
13,6	3482	2,3	103,12	B153	132S4	65000	65000
11,3	4183	1,9	123,88	B153	132S4	65000	65000
10,4	4534	1,8	134,27	B153	132S4	65000	65000
9,4	5040	1,6	149,26	B153	132S4	65000	65000
8,5	5585	1,4	165,42	B153	132S4	65000	65000



7,50 kW

n2 [1/min]	M2 [Nm]	f.s.	i			Fr2 (a) [N]	Fr2 (b) [N]
179,3	360	1,4	7,81	B083	132L4	12548	3585
162,4	397	1,5	8,62	B083	132L4	12862	3675
133,4	483	1,3	10,49	B083	132L4	13482	3852
120,8	534	1,4	11,59	B083	132L4	13791	3940
97,0	664	1,2	14,43	B083	132L4	14459	4131
84,4	764	1,1	16,60	B083	132L4	14866	4247
76,4	844	1,0	18,32	B083	132L4	15140	4326
172,3	374	2,1	8,13	B103	132L4	16093	4598
156,1	413	2,2	8,97	B103	132L4	16548	4728
128,2	503	2,0	10,92	B103	132L4	17481	4995
116,2	555	1,8	12,05	B103	132L4	17956	5130
93,4	690	1,7	14,99	B103	132L4	19026	5436
81,1	795	1,8	17,27	B103	132L4	19731	5637
73,5	877	1,6	19,06	B103	132L4	20221	5777
59,1	1091	1,3	23,70	B103	132L4	21303	6087
52,8	1221	1,2	26,51	B103	132L4	21853	6244
45,8	1407	1,1	30,55	B103	132L4	22000	6438
42,3	1523	1,1	33,07	B103	132L4	22000	6544
39,0	1652	1,0	35,87	B103	132L4	22000	6650
45,5	1418	2,0	30,79	B123	132L4	30000	8942
44,8	1440	1,9	31,26	B123	132L4	30000	8968
40,4	1597	1,8	34,68	B123	132L4	30000	9139
34,5	1866	1,5	40,53	B123	132L4	30000	9378
31,2	2067	1,5	44,89	B123	132L4	30000	9520
28,1	2293	1,4	49,80	B123	132L4	30000	9650
25,8	2500	1,3	54,30	B123	132L4	30000	9744
23,6	2733	1,2	59,36	B123	132L4	30000	9827
22,4	2882	1,1	62,59	B123	132L4	30000	9868
20,2	3197	1,0	69,43	B123	132L4	30000	9930
18,8	3426	1,0	74,42	B123	132L4	30000	9956
17,5	3685	0,9	80,04	B123	132L4	30000	9968
15,6	4138	0,8	89,87	B123	132L4	30000	9950
26,3	2448	2,0	53,16	B143	132L4	38937	38937
25,6	2515	2,0	54,63	B143	132L4	39126	39126
23,7	2717	1,8	59,02	B143	132L4	39644	39644
21,6	2987	1,7	64,88	B143	132L4	40244	40244
19,9	3243	1,5	70,43	B143	132L4	40727	40727
18,2	3551	1,4	77,12	B143	132L4	41212	41212
16,4	3939	1,3	85,54	B143	132L4	41698	41698



7,50 kW

n2 [1/min]	M2 [Nm]	f.s.	i			Fr2 (a) [N]	Fr2 (b) [N]
14,9	4334	1,2	94,13	B143	132L4	42070	42070
13,2	4873	1,0	105,83	B143	132L4	42408	42408
12,5	5154	1,0	111,94	B143	132L4	42518	42518
11,2	5738	0,9	124,62	B143	132L4	42622	42622
16,7	3863	2,1	83,89	B153	132L4	65000	65000
16,0	4036	2,0	87,65	B153	132L4	65000	65000
15,0	4284	1,9	93,05	B153	132L4	65000	65000
13,6	4748	1,7	103,12	B153	132L4	65000	65000
11,3	5704	1,4	123,88	B153	132L4	65000	65000
10,4	6182	1,3	134,27	B153	132L4	65000	65000
9,4	6873	1,2	149,26	B153	132L4	65000	65000
8,5	7616	1,1	165,42	B153	132L4	65000	65000



9,20 kW

n2 [1/min]	M2 [Nm]	f.s.	i			Fr2 (a) [N]	Fr2 (b) [N]
179,3	441	1,1	7,81	B083	132M4	12218	3491
162,4	487	1,2	8,62	B083	132M4	12497	3571
133,4	593	1,1	10,49	B083	132M4	13039	3725
120,8	654	1,1	11,59	B083	132M4	13302	3801
97,0	815	1,0	14,43	B083	132M4	13850	3957
172,3	459	1,7	8,13	B103	132M4	15849	4528
156,1	506	1,8	8,97	B103	132M4	16279	4651
128,2	617	1,6	10,92	B103	132M4	17153	4901
116,2	681	1,5	12,05	B103	132M4	17595	5027
93,4	846	1,4	14,99	B103	132M4	18576	5308
81,1	975	1,4	17,27	B103	132M4	19213	5489
73,5	1076	1,3	19,06	B103	132M4	19649	5614
59,1	1339	1,0	23,70	B103	132M4	20592	5883
52,8	1498	1,0	26,51	B103	132M4	21057	6016
45,8	1726	0,9	30,55	B103	132M4	21616	6176
61,5	1287	2,2	22,78	B123	132M4	28320	8091
54,1	1462	1,9	25,89	B123	132M4	28989	8282
50,9	1554	1,8	27,51	B123	132M4	29291	8369
45,5	1739	1,6	30,79	B123	132M4	29819	8520
44,8	1766	1,6	31,26	B123	132M4	29887	8539
40,4	1959	1,4	34,68	B123	132M4	30000	8664
34,5	2289	1,2	40,53	B123	132M4	30000	8823
31,2	2536	1,2	44,89	B123	132M4	30000	8905
28,1	2813	1,1	49,80	B123	132M4	30000	8967
25,8	3067	1,0	54,30	B123	132M4	30000	9000
23,6	3353	1,0	59,36	B123	132M4	30000	9014
22,4	3535	0,9	62,59	B123	132M4	30000	9011
34,7	2276	2,1	40,29	B143	132M4	35384	35384
31,7	2494	1,9	44,16	B143	132M4	35938	35938
29,0	2731	1,8	48,35	B143	132M4	36451	36451
26,3	3002	1,7	53,16	B143	132M4	36946	36946
25,6	3085	1,6	54,63	B143	132M4	37080	37080
23,7	3333	1,5	59,02	B143	132M4	37434	37434
21,6	3665	1,4	64,88	B143	132M4	37814	37814
19,9	3978	1,3	70,43	B143	132M4	38088	38088
18,2	4356	1,1	77,12	B143	132M4	38324	38324
16,4	4832	1,0	85,54	B143	132M4	38494	38494
14,9	5316	0,9	94,13	B143	132M4	38544	38544
13,2	5977	0,8	105,83	B143	132M4	38444	38444
19,7	4018	2,0	71,15	B153	132M4	65000	65000



9,20 kW

n2 [1/min]	M2 [Nm]	f.s.	i			Fr2 (a) [N]	Fr2 (b) [N]
18,1	4362	1,8	77,22	B153	132M4	65000	65000
16,7	4738	1,7	83,89	B153	132M4	65000	65000
16,0	4951	1,6	87,65	B153	132M4	65000	65000
15,0	5255	1,5	93,05	B153	132M4	65000	65000
13,6	5824	1,4	103,12	B153	132M4	65000	65000
11,3	6997	1,1	123,88	B153	132M4	65000	65000
10,4	7584	1,1	134,27	B153	132M4	65000	65000
9,4	8431	0,9	149,26	B153	132M4	65000	65000



11,00 kW

n2 [1/min]	M2 [Nm]	f.s.	i			Fr2 (a) [N]	Fr2 (b) [N]
172,3	549	1,5	8,13	B103	160M4	15591	4454
156,1	606	1,5	8,97	B103	160M4	15994	4570
128,2	738	1,4	10,92	B103	160M4	16806	4802
116,2	814	1,2	12,05	B103	160M4	17212	4918
93,4	1012	1,2	14,99	B103	160M4	18100	5172
81,1	1166	1,2	17,27	B103	160M4	18664	5333
73,5	1287	1,1	19,06	B103	160M4	19044	5441
59,1	1600	0,9	23,70	B103	160M4	19839	5668
112,2	843	2,4	12,48	B123	160M4	24194	6912
101,1	935	2,2	13,84	B123	160M4	24748	7071
91,0	1039	2,0	15,38	B123	160M4	25298	7228
75,4	1254	1,8	18,58	B123	160M4	26238	7497
67,9	1392	1,8	20,61	B123	160M4	26723	7635
61,5	1538	1,8	22,78	B123	160M4	27163	7761
54,1	1748	1,6	25,89	B123	160M4	27674	7907
50,9	1858	1,5	27,51	B123	160M4	27893	7970
45,5	2080	1,3	30,79	B123	160M4	28255	8073
44,8	2111	1,3	31,26	B123	160M4	28299	8085
40,4	2342	1,2	34,68	B123	160M4	28562	8160
34,5	2737	1,0	40,53	B123	160M4	28821	8235
31,2	3032	1,0	44,89	B123	160M4	28888	8254
28,1	3363	1,0	49,80	B123	160M4	28856	8245
42,4	2229	2,1	33,01	B143	160M4	32778	32778
38,2	2477	1,9	36,67	B143	160M4	33331	33331
34,7	2721	1,8	40,29	B143	160M4	33786	33786
31,7	2982	1,6	44,16	B143	160M4	34186	34186
29,0	3265	1,5	48,35	B143	160M4	34534	34534
26,3	3590	1,4	53,16	B143	160M4	34838	34838
25,6	3689	1,4	54,63	B143	160M4	34913	34913
23,7	3985	1,3	59,02	B143	160M4	35093	35093
21,6	4382	1,1	64,88	B143	160M4	35241	35241
19,9	4757	1,1	70,43	B143	160M4	35295	35295
18,2	5208	1,0	77,12	B143	160M4	35265	35265
16,4	5777	0,9	85,54	B143	160M4	35101	35101
25,6	3690	2,2	54,64	B153	160M4	62261	62261
24,4	3868	2,1	57,27	B153	160M4	63059	63059
23,0	4114	1,9	60,92	B153	160M4	64114	64114
22,1	4286	1,9	63,47	B153	160M4	64816	64816
19,7	4805	1,7	71,15	B153	160M4	65000	65000
18,1	5215	1,5	77,22	B153	160M4	65000	65000
16,7	5665	1,4	83,89	B153	160M4	65000	65000
16,0	5919	1,4	87,65	B153	160M4	65000	65000
15,0	6284	1,3	93,05	B153	160M4	65000	65000
13,6	6964	1,1	103,12	B153	160M4	65000	65000



11,00 kW

n2 [1/min]	M2 [Nm]	f.s.	i			Fr2 (a) [N]	Fr2 (b) [N]
11,3	8366	1,0	123,88	B153	160M4	65000	65000
10,4	9067	0,9	134,27	B153	160M4	65000	65000
85,4	1107	8,9	16,39	B163	160M4	65000	77086
77,7	1217	8,5	18,02	B163	160M4	65000	79143
70,2	1348	7,9	19,96	B163	160M4	65000	80000
63,8	1482	7,0	21,94	B163	160M4	65000	80000
57,9	1632	6,4	24,17	B163	160M4	65000	80000
52,7	1795	6,2	26,58	B163	160M4	65000	80000
48,6	1945	5,2	28,80	B163	160M4	65000	80000
45,3	2088	5,5	30,92	B163	160M4	65000	80000
40,9	2313	5,1	34,25	B163	160M4	65000	80000
37,2	2543	4,8	37,66	B163	160M4	65000	80000
34,4	2745	4,6	40,65	B163	160M4	65000	80000
31,0	3045	3,9	45,09	B163	160M4	65000	80000
27,5	3444	3,8	51,00	B163	160M4	65000	80000
26,1	3622	3,6	53,63	B163	160M4	65000	80000
23,7	3982	3,3	58,97	B163	160M4	65000	80000
20,1	4712	2,8	69,78	B163	160M4	65000	80000
18,2	5181	2,5	76,72	B163	160M4	65000	80000
16,0	5912	2,2	87,54	B163	160M4	65000	80000
14,5	6500	2,0	96,25	B163	160M4	65000	80000
13,5	7019	1,9	103,93	B163	160M4	65000	80000
12,3	7717	1,7	114,27	B163	160M4	65000	80000
11,1	8528	1,5	126,29	B163	160M4	65000	80000
10,1	9377	1,4	138,85	B163	160M4	65000	80000
9,0	10456	1,2	154,83	B163	160M4	65000	80000



15,00 kW

n2 [1/min]	M2 [Nm]	f.s.	i			Fr2 (a) [N]	Fr2 (b) [N]
172,3	748	1,1	8,13	B103	160L4	15017	4290
156,1	826	1,1	8,97	B103	160L4	15361	4389
128,2	1006	1,0	10,92	B103	160L4	16035	4581
116,2	1110	0,9	12,05	B103	160L4	16361	4675
93,4	1380	0,9	14,99	B103	160L4	17042	4869
81,1	1590	0,9	17,27	B103	160L4	17444	4984
175,8	734	2,0	7,97	B123	160L4	20831	5952
145,5	886	2,0	9,62	B123	160L4	21685	6196
135,5	952	2,1	10,33	B123	160L4	21999	6286
112,2	1149	1,7	12,48	B123	160L4	22785	6510
101,1	1275	1,6	13,84	B123	160L4	23185	6624
91,0	1417	1,5	15,38	B123	160L4	23562	6732
75,4	1711	1,3	18,58	B123	160L4	24142	6898
67,9	1898	1,3	20,61	B123	160L4	24397	6971
61,5	2098	1,3	22,78	B123	160L4	24591	7026
54,1	2384	1,2	25,89	B123	160L4	24751	7072
50,9	2533	1,1	27,51	B123	160L4	24788	7082
45,5	2836	1,0	30,79	B123	160L4	24779	7080
44,8	2879	1,0	31,26	B123	160L4	24770	7077
40,4	3194	0,9	34,68	B123	160L4	24647	7042
36,7	3334	2,3	14,49	B143	160L4	26286	26286
82,2	1569	2,0	17,04	B143	160L4	27153	27153
75,0	1718	2,1	18,66	B143	160L4	27614	27614
66,7	1934	2,1	21,00	B143	160L4	28183	28183
61,5	2097	2,1	22,77	B143	160L4	28550	28550
54,6	2360	1,9	25,63	B143	160L4	29041	29041



15,00 kW

n2 [1/min]	M2 [Nm]	f.s.	i			Fr2 (a) [N]	Fr2 (b) [N]
51,0	2527	1,8	27,44	B143	160L4	29297	29297
46,6	2767	1,7	30,05	B143	160L4	29602	29602
42,4	3040	1,5	33,01	B143	160L4	29869	29869
38,2	3377	1,4	36,67	B143	160L4	30099	30099
34,7	3710	1,3	40,29	B143	160L4	30235	30235
31,7	4067	1,2	44,16	B143	160L4	30294	30294
29,0	4453	1,1	48,35	B143	160L4	30272	30272
26,3	4895	1,0	53,16	B143	160L4	30153	30153
25,6	5031	1,0	54,63	B143	160L4	30099	30099
23,7	5435	0,9	59,02	B143	160L4	29892	29892
21,6	5975	0,8	64,88	B143	160L4	29522	29522
33,1	3895	2,1	42,30	B153	160L4	56476	56476
29,5	4377	1,8	47,53	B153	160L4	58211	58211
27,7	4656	1,7	50,56	B153	160L4	59133	59133
25,6	5032	1,6	54,64	B153	160L4	60293	60293
24,4	5274	1,5	57,27	B153	160L4	60996	60996
23,0	5610	1,4	60,92	B153	160L4	61919	61919
22,1	5845	1,4	63,47	B153	160L4	62529	62529
19,7	6552	1,2	71,15	B153	160L4	64222	64222
18,1	7111	1,1	77,22	B153	160L4	65000	65000
16,7	7725	1,0	83,89	B153	160L4	65000	65000
16,0	8072	1,0	87,65	B153	160L4	65000	65000
15,0	8569	0,9	93,05	B153	160L4	65000	65000
77,7	1659	6,3	18,02	B163	160L4	65000	77927
70,2	1838	5,8	19,96	B163	160L4	65000	80000
63,8	2021	5,1	21,94	B163	160L4	65000	80000
57,9	2226	4,7	24,17	B163	160L4	65000	80000
52,7	2448	4,5	26,58	B163	160L4	65000	80000
48,6	2652	3,8	28,80	B163	160L4	65000	80000
45,3	2848	4,0	30,92	B163	160L4	65000	80000
40,9	3154	3,8	34,25	B163	160L4	65000	80000
37,2	3468	3,5	37,66	B163	160L4	65000	80000
34,4	3744	3,4	40,65	B163	160L4	65000	80000
31,0	4152	2,9	45,09	B163	160L4	65000	80000
27,5	4697	2,8	51,00	B163	160L4	65000	80000
26,1	4939	2,6	53,63	B163	160L4	65000	80000
23,7	5430	2,4	58,97	B163	160L4	65000	80000
20,1	6426	2,0	69,78	B163	160L4	65000	80000
18,2	7065	1,8	76,72	B163	160L4	65000	80000
16,0	8061	1,6	87,54	B163	160L4	65000	80000
14,5	8863	1,5	96,25	B163	160L4	65000	80000
13,5	9571	1,4	103,93	B163	160L4	65000	80000
12,3	10523	1,2	114,27	B163	160L4	65000	80000
11,1	11630	1,1	126,29	B163	160L4	65000	80000
10,1	12787	1,0	138,85	B163	160L4	65000	80000
9,0	14258	0,9	154,83	B163	160L4	65000	80000



18,50 kW

n2 [1/min]	M2 [Nm]	f.s.	i			Fr2 (a) [N]	Fr2 (b) [N]
175,8	905	1,7	7,97	B123	180M4	20044	5727
145,5	1093	1,6	9,62	B123	180M4	20735	5924
135,5	1174	1,7	10,33	B123	180M4	20979	5994
112,2	1417	1,4	12,48	B123	180M4	21553	6158
101,1	1572	1,3	13,84	B123	180M4	21818	6234
91,0	1747	1,2	15,38	B123	180M4	22043	6298



18,50 kW

n2 [1/min]	M2 [Nm]	f.s.	i			Fr2 (a) [N]	Fr2 (b) [N]
75,4	2110	1,0	18,58	B123	180M4	22307	6373
67,9	2341	1,1	20,61	B123	180M4	22362	6389
61,5	2587	1,1	22,78	B123	180M4	22341	6383
54,1	2940	1,0	25,89	B123	180M4	22194	6341
50,9	3124	0,9	27,51	B123	180M4	22071	6306
129,2	1231	2,4	10,84	B143	180M4	23819	23819
118,0	1348	2,3	11,87	B143	180M4	24258	24258
96,7	1645	1,9	14,49	B143	180M4	25169	25169
82,2	1935	1,7	17,04	B143	180M4	25839	25839
75,0	2119	1,7	18,66	B143	180M4	26175	26175
66,7	2385	1,7	21,00	B143	180M4	26564	26564
61,5	2586	1,7	22,77	B143	180M4	26794	26794
54,6	2911	1,6	25,63	B143	180M4	27064	27064
51,0	3117	1,5	27,44	B143	180M4	27181	27181
46,6	3412	1,4	30,05	B143	180M4	27285	27285
42,4	3749	1,3	33,01	B143	180M4	27323	27323
38,2	4165	1,2	36,67	B143	180M4	27271	27271
34,7	4576	1,0	40,29	B143	180M4	27128	27128
31,7	5016	1,0	44,16	B143	180M4	26888	26888
29,0	5492	0,9	48,35	B143	180M4	26544	26544
26,3	6037	0,8	53,16	B143	180M4	26054	26054
41,6	3820	2,1	33,63	B153	180M4	52056	52056
40,0	3977	2,0	35,02	B153	180M4	52598	52598
36,1	4408	1,8	38,81	B153	180M4	53983	53983
33,1	4804	1,7	42,30	B153	180M4	55143	55143
29,5	5399	1,5	47,53	B153	180M4	56713	56713
27,7	5743	1,4	50,56	B153	180M4	57539	57539
25,6	6206	1,3	54,64	B153	180M4	58570	58570
24,4	6505	1,2	57,27	B153	180M4	59191	59191
23,0	6919	1,2	60,92	B153	180M4	59998	59998
22,1	7209	1,1	63,47	B153	180M4	60529	60529
19,7	8081	1,0	71,15	B153	180M4	61980	61980
18,1	8771	0,9	77,22	B153	180M4	62991	62991
157,4	1010	6,7	8,89	B163	180M4	63836	63836
132,4	1201	6,6	10,58	B163	180M4	65000	66953
117,9	1348	5,7	11,87	B163	180M4	65000	68905
109,3	1455	6,0	12,81	B163	180M4	65000	70405
99,4	1600	6,0	14,08	B163	180M4	65000	72217
90,2	1763	5,7	15,52	B163	180M4	65000	74036
85,4	1861	5,3	16,39	B163	180M4	65000	74982
77,7	2046	5,1	18,02	B163	180M4	65000	76864
70,2	2267	4,7	19,96	B163	180M4	65000	78829
63,8	2492	4,2	21,94	B163	180M4	65000	80000
57,9	2745	3,8	24,17	B163	180M4	65000	80000
52,7	3019	3,7	26,58	B163	180M4	65000	80000
48,6	3271	3,1	28,80	B163	180M4	65000	80000
45,3	3512	3,3	30,92	B163	180M4	65000	80000
40,9	3890	3,1	34,25	B163	180M4	65000	80000
37,2	4277	2,9	37,66	B163	180M4	65000	80000
34,4	4617	2,8	40,65	B163	180M4	65000	80000
31,0	5121	2,3	45,09	B163	180M4	65000	80000
27,5	5792	2,2	51,00	B163	180M4	65000	80000
26,1	6091	2,1	53,63	B163	180M4	65000	80000
23,7	6697	1,9	58,97	B163	180M4	65000	80000
20,1	7925	1,6	69,78	B163	180M4	65000	80000
18,2	8713	1,5	76,72	B163	180M4	65000	80000
16,0	9942	1,3	87,54	B163	180M4	65000	80000
14,5	10931	1,2	96,25	B163	180M4	65000	80000



18,50 kW

n2 [1/min]	M2 [Nm]	f.s.	i			Fr2 (a) [N]	Fr2 (b) [N]
13,5	11804	1,1	103,93	B163	180M4	65000	80000
12,3	12979	1,0	114,27	B163	180M4	65000	80000
11,1	14343	0,9	126,29	B163	180M4	65000	80000
10,1	15770	0,8	138,85	B163	180M4	65000	80000
9,0	17585	0,7	154,83	B163	180M4	65000	80000



22,00 kW

n2 [1/min]	M2 [Nm]	f.s.	i			Fr2 (a) [N]	Fr2 (b) [N]
175,8	1076	1,4	7,97	B123	180L4	19257	5502
145,5	1299	1,4	9,62	B123	180L4	19785	5653
135,5	1396	1,4	10,33	B123	180L4	19958	5702
112,2	1686	1,2	12,48	B123	180L4	20320	5806
101,1	1870	1,1	13,84	B123	180L4	20451	5843
91,0	2078	1,0	15,38	B123	180L4	20523	5864
75,4	2509	0,9	18,58	B123	180L4	20472	5849
67,9	2783	0,9	20,61	B123	180L4	20326	5807
129,2	1464	2,0	10,84	B143	180L4	22984	22984
118,0	1603	1,9	11,87	B143	180L4	23342	23342
96,7	1956	1,6	14,49	B143	180L4	24052	24052
82,2	2302	1,4	17,04	B143	180L4	24524	24524
75,0	2520	1,4	18,66	B143	180L4	24736	24736
66,7	2836	1,4	21,00	B143	180L4	24945	24945
61,5	3076	1,4	22,77	B143	180L4	25038	25038
54,6	3461	1,3	25,63	B143	180L4	25088	25088
51,0	3706	1,2	27,44	B143	180L4	25065	25065
46,6	4058	1,2	30,05	B143	180L4	24968	24968
42,4	4458	1,1	33,01	B143	180L4	24778	24778
38,2	4953	1,0	36,67	B143	180L4	24443	24443
34,7	5442	0,9	40,29	B143	180L4	24021	24021
30,9	6080	0,8	45,00	B153	180L4	23500	23500
27,7	6829	0,7	50,56	B153	180L4	22946	22946
25,6	7380	0,6	56,25	B153	180L4	22360	22360
24,4	7736	0,5	60,27	B153	180L4	21835	21835
23,0	8229	0,4	65,92	B153	180L4	21368	21368
22,1	8573	0,3	70,47	B153	180L4	20958	20958
157,4	1201	5,7	8,89	B163	180L4	63287	63287
132,4	1428	5,5	10,58	B163	180L4	65000	66319
117,9	1603	4,8	11,87	B163	180L4	65000	68172
109,3	1730	5,1	12,81	B163	180L4	65000	69638
99,4	1902	5,0	14,08	B163	180L4	65000	71385
90,2	2096	4,8	15,52	B163	180L4	65000	73120
85,4	2213	4,5	16,39	B163	180L4	65000	74001
77,7	2433	4,3	18,02	B163	180L4	65000	75801
70,2	2695	4,0	19,96	B163	180L4	65000	77651



22,00 kW

n2 [1/min]	M2 [Nm]	f.s.	i			Fr2 (a) [N]	Fr2 (b) [N]
63,8	2964	3,5	21,94	B163	180L4	65000	79371
57,9	3265	3,2	24,17	B163	180L4	65000	80000
52,7	3590	3,1	26,58	B163	180L4	65000	80000
48,6	3890	2,6	28,80	B163	180L4	65000	80000
45,3	4177	2,8	30,92	B163	180L4	65000	80000
40,9	4626	2,6	34,25	B163	180L4	65000	80000
37,2	5087	2,4	37,66	B163	180L4	65000	80000
34,4	5491	2,3	40,65	B163	180L4	65000	80000
31,0	6090	2,0	45,09	B163	180L4	65000	80000
27,5	6888	1,9	51,00	B163	180L4	65000	80000
26,1	7243	1,8	53,63	B163	180L4	65000	80000
23,7	7964	1,6	58,97	B163	180L4	65000	80000
20,1	9424	1,4	69,78	B163	180L4	65000	80000
18,2	10362	1,3	76,72	B163	180L4	65000	80000
16,0	11823	1,1	87,54	B163	180L4	65000	80000
14,5	12999	1,0	96,25	B163	180L4	65000	80000
13,5	14037	0,9	103,93	B163	180L4	65000	80000
12,3	15434	0,8	114,27	B163	180L4	65000	80000
11,1	17057	0,8	126,29	B163	180L4	65000	80000
10,1	18754	0,7	138,85	B163	180L4	65000	80000
9,0	20912	0,6	154,83	B163	180L4	65000	80000



30,00 kW

n2 [1/min]	M2 [Nm]	f.s.	i			Fr2 (a) [N]	Fr2 (b) [N]
129,2	1996	1,5	10,84	B143	200L4	21073	21073
118,0	2186	1,4	11,87	B143	200L4	21251	21251
96,7	2668	1,2	14,49	B143	200L4	21498	21498
82,2	3139	1,0	17,04	B143	200L4	21521	21521
75,0	3436	1,0	18,66	B143	200L4	21448	21448
66,7	3867	1,0	21,00	B143	200L4	21244	21244
61,5	4194	1,0	22,77	B143	200L4	21024	21024
54,6	4720	1,0	25,63	B143	200L4	20571	20571
51,0	5054	0,9	27,44	B143	200L4	20228	20228
46,6	5534	0,8	30,05	B143	200L4	19672	19672
133,4	1932	2,3	10,49	B153	200L4	36423	36423
110,7	2328	1,9	12,64	B153	200L4	38333	38333
99,9	2580	1,9	14,01	B153	200L4	39403	39403
90,9	2836	1,8	15,40	B153	200L4	40397	40397
75,4	3418	1,8	18,56	B153	200L4	42371	42371
68,1	3787	1,7	20,56	B153	200L4	43463	43463
58,7	4394	1,5	23,86	B153	200L4	45037	45037
55,6	4639	1,5	25,19	B153	200L4	45607	45607
49,6	5200	1,5	28,23	B153	200L4	46795	46795
46,1	5590	1,4	30,35	B153	200L4	47538	47538
41,6	6194	1,3	33,63	B153	200L4	48573	48573
40,0	6449	1,2	35,02	B153	200L4	48972	48972
36,1	7147	1,1	38,81	B153	200L4	49963	49963
33,1	7790	1,0	42,30	B153	200L4	50762	50762
29,5	8754	0,9	47,53	B153	200L4	51790	51790
27,7	9312	0,9	50,56	B153	200L4	52303	52303
157,4	1638	4,2	8,89	B163	200L4	62032	62032
132,4	1948	4,1	10,58	B163	200L4	64872	64872
117,9	2186	3,5	11,87	B163	200L4	65000	66497
109,3	2359	3,7	12,81	B163	200L4	65000	67884
99,4	2594	3,7	14,08	B163	200L4	65000	69486



30,00 kW

n2 [1/min]	M2 [Nm]	f.s.	i			Fr2 (a) [N]	Fr2 (b) [N]
90,2	2859	3,5	15,52	B163	200L4	65000	71026
85,4	3018	3,3	16,39	B163	200L4	65000	71757
77,7	3318	3,1	18,02	B163	200L4	65000	73371
70,2	3676	2,9	19,96	B163	200L4	65000	74959
63,8	4042	2,6	21,94	B163	200L4	65000	76411
57,9	4452	2,4	24,17	B163	200L4	65000	77678
52,7	4895	2,3	26,58	B163	200L4	65000	79244
48,6	5304	1,9	28,80	B163	200L4	65000	79708
45,3	5695	2,0	30,92	B163	200L4	65000	80000
40,9	6309	1,9	34,25	B163	200L4	65000	80000
37,2	6936	1,8	37,66	B163	200L4	65000	80000
34,4	7487	1,7	40,65	B163	200L4	65000	80000
31,0	8305	1,4	45,09	B163	200L4	65000	80000
27,5	9393	1,4	51,00	B163	200L4	65000	80000
26,1	9877	1,3	53,63	B163	200L4	65000	80000
23,7	10860	1,2	58,97	B163	200L4	65000	80000
20,1	12851	1,0	69,78	B163	200L4	65000	80000
18,2	14130	0,9	76,72	B163	200L4	65000	80000
16,0	16122	0,8	87,54	B163	200L4	65000	80000
14,5	17726	0,7	96,25	B163	200L4	65000	80000
13,5	19142	0,7	103,93	B163	200L4	65000	80000



37,00 kW

n2 [1/min]	M2 [Nm]	f.s.	i			Fr2 (a) [N]	Fr2 (b) [N]
133,4	2383	1,9	10,49	B153	225S4	35762	35762
110,7	2872	1,6	12,64	B153	225S4	37536	37536
99,9	3182	1,6	14,01	B153	225S4	38520	38520
90,9	3498	1,4	15,40	B153	225S4	39426	39426
75,4	4215	1,4	18,56	B153	225S4	41202	41202
68,1	4671	1,4	20,56	B153	225S4	42167	42167
58,7	5419	1,2	23,86	B153	225S4	43533	43533
55,6	5721	1,2	25,19	B153	225S4	44019	44019
46,1	6894	1,2	30,35	B153	225S4	45625	45625
41,6	7640	1,0	33,63	B153	225S4	46453	46453
40,0	7954	1,0	35,02	B153	225S4	46764	46764
36,1	8815	0,9	38,81	B153	225S4	47517	47517
157,4	2020	3,4	8,89	B163	225S4	60934	60934
132,4	2402	3,3	10,58	B163	225S4	63605	63605
117,9	2696	2,9	11,87	B163	225S4	65000	65031
109,3	2910	3,0	12,81	B163	225S4	65000	66350
99,4	3199	3,0	14,08	B163	225S4	65000	67823
90,2	3526	2,8	15,52	B163	225S4	65000	69194
85,4	3722	2,7	16,39	B163	225S4	65000	69794
77,7	4092	2,5	18,02	B163	225S4	65000	71244
70,2	4533	2,4	19,96	B163	225S4	65000	72604
63,8	4985	2,1	21,94	B163	225S4	65000	73821
57,9	5491	1,9	24,17	B163	225S4	65000	74782
52,7	6037	1,8	26,58	B163	225S4	65000	76107
48,6	6542	1,6	28,80	B163	225S4	65000	76151
45,3	7024	1,6	30,92	B163	225S4	65000	77416
40,9	7781	1,5	34,25	B163	225S4	65000	78329
37,2	8555	1,4	37,66	B163	225S4	65000	79409
34,4	9234	1,4	40,65	B163	225S4	65000	79930
31,0	10243	1,2	45,09	B163	225S4	65000	79187
27,5	11585	1,1	51,00	B163	225S4	65000	80000



37,00 kW

n2 [1/min]	M2 [Nm]	f.s.	i			Fr2 (a) [N]	Fr2 (b) [N]
26,1	12182	1,1	53,63	B163	225S4	65000	80000
23,7	13394	1,0	58,97	B163	225S4	65000	80000
20,1	15850	0,8	69,78	B163	225S4	65000	79635



45,00 kW

n2 [1/min]	M2 [Nm]	f.s.	i			Fr2 (a) [N]	Fr2 (b) [N]
133,4	2899	1,6	10,49	B153	225M4	35006	35006
110,7	3493	1,3	12,64	B153	225M4	36625	36625
99,9	3871	1,3	14,01	B153	225M4	37511	37511
90,9	4254	1,2	15,40	B153	225M4	38317	38317
75,4	5126	1,2	18,56	B153	225M4	39865	39865
68,1	5681	1,1	20,56	B153	225M4	40685	40685
58,7	6591	1,0	23,86	B153	225M4	41814	41814
55,6	6958	1,0	25,19	B153	225M4	42204	42204
49,6	7799	1,0	28,23	B153	225M4	42982	42982
46,1	8384	1,0	30,35	B153	225M4	43438	43438
157,4	2457	2,8	8,89	B163	225M4	59679	59679
132,4	2922	2,7	10,58	B163	225M4	62157	62157
117,9	3279	2,3	11,87	B163	225M4	63356	63356
109,3	3539	2,5	12,81	B163	225M4	64596	64596
99,4	3891	2,5	14,08	B163	225M4	65000	65923
90,2	4288	2,3	15,52	B163	225M4	65000	67100
85,4	4527	2,2	16,39	B163	225M4	65000	67551
77,7	4977	2,1	18,02	B163	225M4	65000	68814
70,2	5513	1,9	19,96	B163	225M4	65000	69912
63,8	6062	1,7	21,94	B163	225M4	65000	70861
57,9	6678	1,6	24,17	B163	225M4	65000	71473
52,7	7343	1,5	26,58	B163	225M4	65000	72522
48,6	7957	1,3	28,80	B163	225M4	65000	72087
45,3	8543	1,3	30,92	B163	225M4	65000	73182
40,9	9463	1,3	34,25	B163	225M4	65000	73640
37,2	10405	1,2	37,66	B163	225M4	65000	74329
34,4	11231	1,1	40,65	B163	225M4	65000	74446
31,0	12457	1,0	45,09	B163	225M4	65000	72823
27,5	14090	0,9	51,00	B163	225M4	65000	74006
26,1	14816	0,9	53,63	B163	225M4	65000	73117
23,7	16290	0,8	58,97	B163	225M4	65000	72978
20,1	19277	0,7	69,78	B163	225M4	65000	70082



55,00 kW

n2 [1/min]	M2 [Nm]	f.s.	i			Fr2 (a) [N]	Fr2 (b) [N]
157,4	3002	2,3	8,89	B163	250M4	58110	58110
132,4	3571	2,2	10,58	B163	250M4	60347	60347
117,9	4008	1,9	11,87	B163	250M4	61262	61262
109,3	4325	2,0	12,81	B163	250M4	62404	62404
99,4	4755	2,0	14,08	B163	250M4	63549	63549
90,2	5241	1,9	15,52	B163	250M4	64483	64483
85,4	5533	1,8	16,39	B163	250M4	64747	64747
77,7	6083	1,7	18,02	B163	250M4	65000	65776
70,2	6739	1,6	19,96	B163	250M4	65000	66547
63,8	7410	1,4	21,94	B163	250M4	65000	67161



55,00 kW

n2 [1/min]	M2 [Nm]	f.s.	i			Fr2 (a) [N]	Fr2 (b) [N]
57,9	8162	1,3	24,17	B163	250M4	65000	67336
52,7	8974	1,2	26,58	B163	250M4	65000	68040
48,6	9725	1,0	28,80	B163	250M4	65000	67007
45,3	10442	1,1	30,92	B163	250M4	65000	67890
40,9	11566	1,0	34,25	B163	250M4	65000	67778
37,2	12717	1,0	37,66	B163	250M4	65000	67978
34,4	13727	0,9	40,65	B163	250M4	65000	67591
31,0	15225	0,8	45,09	B163	250M4	64869	64869
27,5	17221	0,8	51,00	B163	250M4	65000	65407
26,1	18108	0,7	53,63	B163	250M4	63939	63939
23,7	19910	0,7	58,97	B163	250M4	63035	63035

75,00 kW

n2 [1/min]	M2 [Nm]	f.s.	i			Fr2 (a) [N]	Fr2 (b) [N]
157,4	4094	1,7	8,89	B163	280S4	54973	54973
132,4	4869	1,6	10,58	B163	280S4	56727	56727
117,9	5465	1,4	11,87	B163	280S4	57075	57075
109,3	5898	1,5	12,81	B163	280S4	58020	58020
99,4	6485	1,5	14,08	B163	280S4	58799	58799
90,2	7147	1,4	15,52	B163	280S4	59248	59248
85,4	7545	1,3	16,39	B163	280S4	59138	59138
77,7	8296	1,3	18,02	B163	280S4	59700	59700
63,8	10104	1,0	21,94	B163	280S4	59760	59760
57,9	11130	0,9	24,17	B163	280S4	59062	59062
52,7	12238	0,9	26,58	B163	280S4	59077	59077
45,3	14238	0,8	30,92	B163	280S4	57306	57306

90,00 kW

n2 [1/min]	M2 [Nm]	f.s.	i			Fr2 (a) [N]	Fr2 (b) [N]
157,4	4913	1,4	8,89	B163	280M4	52620	52620
132,4	5843	1,4	10,58	B163	280M4	54012	54012
117,9	6558	1,2	11,87	B163	280M4	53934	53934
109,3	7077	1,2	12,81	B163	280M4	54732	54732
99,4	7782	1,2	14,08	B163	280M4	55237	55237
90,2	8576	1,2	15,52	B163	280M4	55322	55322
85,4	9054	1,1	16,39	B163	280M4	54932	54932
77,7	9955	1,0	18,02	B163	280M4	55143	55143
63,8	12125	0,9	21,94	B163	280M4	54210	54210
57,9	13356	0,8	24,17	B163	280M4	52857	52857
52,7	14685	0,8	26,58	B163	280M4	52355	52355
45,3	17086	0,7	30,92	B163	280M4	49368	49368

IBA/IB - Prestazioni / Performance / Performances / Leistungen / Prestaciones / 性能 (n1=1400 rpm)
IBA42

M2 [Nm]	i	P1 [kW]	n2 [1/min]	Fr1 [N]	Fr2 (a) [N]	Fr2 (b) [N]
90	7,62	1,82	183,8	373	-	1814
90	10,62	1,31	131,8	355	-	2027
90	12,95	1,07	108,1	406	-	2165
90	14,46	0,96	96,8	443	-	2246
120	16,47	1,12	85,0	521	-	2346
120	22,97	0,81	60,9	355	-	2621
120	28,00	0,66	50,0	406	-	2800
120	31,27	0,59	44,8	443	-	2905
120	33,78	0,55	41,4	458	-	2981
120	47,12	0,39	29,7	355	-	3331
120	57,43	0,32	24,4	406	-	3558
110	64,13	0,26	21,8	406	-	3691
110	78,17	0,22	17,9	406	-	3943

IBA52

M2 [Nm]	i	P1 [kW]	n2 [1/min]	Fr1 [N]	Fr2 (a) [N]	Fr2 (b) [N]
160	7,91	3,12	176,9	373	-	1969
160	9,46	2,61	148,0	414	-	2090
160	11,57	2,13	121,0	405	-	2235
160	14,63	1,69	95,7	392	-	2416
200	17,11	1,80	81,8	494	-	2546
200	20,46	1,51	68,4	414	-	2702
200	25,03	1,23	55,9	405	-	2890
200	31,63	0,98	44,3	373	-	3124
200	35,10	0,88	39,9	424	-	3235
200	41,97	0,74	33,4	436	-	3433
220	51,34	0,66	27,3	445	-	3672
200	64,87	0,48	21,6	356	-	3970
200	79,07	0,39	17,7	406	-	4000

IBA53

M2 [Nm]	i	P1 [kW]	n2 [1/min]	Fr1 [N]	Fr2 (a) [N]	Fr2 (b) [N]
220	73,70	0,49	19,0	472	-	4000
220	93,33	0,38	15,0	472	-	4000
220	111,61	0,32	12,5	472	-	4000
220	136,53	0,26	10,3	472	-	4000
220	172,53	0,21	8,1	472	-	4000
220	197,11	0,18	7,1	472	-	4000
220	249,08	0,14	5,6	472	-	4000
220	271,16	0,13	5,2	472	-	4000
220	342,65	0,10	4,1	472	-	4000

IBA72

M2 [Nm]	i	P1 [kW]	n2 [1/min]	Fr1 [N]	Fr2 (a) [N]	Fr2 (b) [N]
350	8,36	6,46	167,5	664	5079	2540
350	10,06	5,37	139,2	685	5403	2701
350	12,44	4,34	112,5	667	5800	2900
420	14,91	4,35	93,9	826	6160	3080
420	17,94	3,61	78,0	685	6552	3276
420	22,19	2,92	63,1	667	7033	3517
420	27,45	2,36	51,0	667	7550	3775
420	33,04	1,96	42,4	685	8031	4016
400	40,87	1,51	34,3	635	8621	4311
350	45,64	1,18	30,7	646	8944	4472
350	54,94	0,98	25,5	685	9515	4757
350	67,96	0,79	20,6	667	10000	5107

IBA73

M2 [Nm]	i	P1 [kW]	n2 [1/min]	Fr1 [N]	Fr2 (a) [N]	Fr2 (b) [N]
450	43,89	1,67	31,9	330	8828	4414
450	52,83	1,39	26,5	411	9391	4696
450	65,35	1,12	21,4	400	10000	5041
450	80,83	0,91	17,3	400	10000	5411
450	97,29	0,75	14,4	411	10000	5500
450	120,34	0,61	11,6	400	10000	5500
450	149,73	0,49	9,4	398	10000	5500
450	180,23	0,41	7,8	411	10000	5500
450	222,93	0,33	6,3	400	10000	5500
450	260,20	0,28	5,4	424	10000	5500
450	321,85	0,23	4,3	400	10000	5500
450	357,95	0,20	3,9	445	10000	5500
450	442,76	0,17	3,2	400	10000	5500

IB063

M2 [Nm]	i	P1 [kW]	n2 [1/min]	Fr1 [N]	Fr2 (a) [N]	Fr2 (b) [N]
290	5,71	8,27	245,0	316	7638	1848
340	6,88	8,05	203,5	233	7876	1757
350	7,32	7,79	191,2	232	8003	1775
460	9,16	8,18	152,8	328	8302	1645
520	10,26	8,25	136,4	318	8403	1511
540	11,03	7,98	127,0	266	8541	1505
580	12,35	7,65	113,3	390	8989	1744
590	13,15	7,31	106,5	361	9052	1670
590	15,18	6,33	92,3	292	9363	1671
600	17,00	5,75	82,3	396	9803	1878
600	22,39	4,36	62,5	488	10923	2400
600	26,09	3,75	53,7	920	11585	2711
600	28,03	3,49	49,9	907	11847	2797
600	33,43	2,92	41,9	975	12000	3250
600	38,58	2,53	36,3	970	12000	3516
600	43,22	2,26	32,4	1018	12000	3857
600	50,81	1,92	27,6	1010	12000	4202

IB063

M2 [Nm]	i	P1 [kW]	n2 [1/min]	Fr1 [N]	Fr2 (a) [N]	Fr2 (b) [N]
600	56,93	1,72	24,6	1054	12000	4569
600	69,16	1,41	20,2	1043	12000	5048
600	77,48	1,26	18,1	1084	12000	5448
600	90,33	1,08	15,5	1065	12000	5854
600	101,20	0,97	13,8	1103	12000	6286
600	111,74	0,87	12,5	1109	12000	6616
600	124,20	0,79	11,3	1085	12000	6915
600	139,15	0,70	10,1	1121	12000	7387
600	157,42	0,62	8,9	1126	12000	7846

IB083

M2 [Nm]	i	P1 [kW]	n2 [1/min]	Fr1 [N]	Fr2 (a) [N]	Fr2 (b) [N]
500	7,81	10,43	179,3	1685	11980	3423
600	8,62	11,33	162,4	1571	12040	3440
650	10,49	10,09	133,4	1728	12807	3659
750	11,59	10,54	120,8	1671	12915	3690
810	14,43	9,14	97,0	1847	13870	3963
850	16,60	8,34	84,4	1948	14518	4148
850	18,32	7,56	76,4	2047	15115	4319
850	22,82	6,07	61,4	2235	16508	4717
850	26,71	5,18	52,4	2346	17573	5021
850	29,50	4,69	47,5	2408	18000	5220
850	31,80	4,35	44,0	2451	18000	5376
850	34,49	4,01	40,6	2494	18000	5549
850	39,60	3,50	35,4	2500	18000	5853
850	42,95	3,22	32,6	2500	18000	6039
850	45,44	3,05	30,8	2500	18000	6171
850	51,19	2,70	27,4	2500	18000	6458
850	55,52	2,49	25,2	2500	18000	6660
850	59,96	2,31	23,4	2500	18000	6856
850	63,74	2,17	22,0	2500	18000	7016
850	69,14	2,00	20,2	2500	18000	7234
850	73,14	1,89	19,1	2500	18000	7388
850	80,76	1,71	17,3	2500	18000	7666
850	92,19	1,50	15,2	2500	18000	8052
850	100,57	1,38	13,9	2500	18000	8315
850	105,29	1,32	13,3	2500	18000	8457
850	116,25	1,19	12,0	2500	18000	8771
850	126,76	1,09	11,0	2500	18000	9053
850	144,77	0,96	9,7	2500	18000	9503

IB103

M2 [Nm]	i	P1 [kW]	n2 [1/min]	Fr1 [N]	Fr2 (a) [N]	Fr2 (b) [N]
800	8,13	16,03	172,3	1078	14868	4248
900	8,97	16,35	156,1	1041	15147	4328
1000	10,92	14,92	128,2	1211	16052	4586
1000	12,05	13,52	116,2	1377	16676	4765
1200	14,99	13,04	93,4	1433	17560	5017
1400	17,27	13,20	81,1	1414	17992	5141
1400	19,06	11,97	73,5	1561	18718	5348
1400	23,70	9,62	59,1	1839	20415	5833

IB103

M2 [Nm]	i	P1 [kW]	n2 [1/min]	Fr1 [N]	Fr2 (a) [N]	Fr2 (b) [N]
1500	26,51	9,22	52,8	1887	21050	6014
1600	30,55	8,53	45,8	1969	21978	6279
1700	33,07	8,37	42,3	1987	22000	6398
1700	35,87	7,72	39,0	2065	22000	6610
1700	41,12	6,73	34,0	2182	22000	6979
1700	44,61	6,21	31,4	2244	22000	7207
1700	47,28	5,86	29,6	2286	22000	7374
1700	50,24	5,51	27,9	2327	22000	7552
1700	53,02	5,22	26,4	2361	22000	7712
1700	58,50	4,73	23,9	2419	22000	8013
1700	64,89	4,27	21,6	2474	22000	8340
1700	68,58	4,04	20,4	2502	22000	8519
1700	72,76	3,81	19,2	2529	22000	8715
1700	78,92	3,51	17,7	2564	22000	8990
1800	83,66	3,50	16,7	2565	22000	9109
1800	92,31	3,18	15,2	2604	22000	9459
1800	105,44	2,78	13,3	2651	22000	9950
1800	114,80	2,55	12,2	2678	22000	10275
1800	120,42	2,43	11,6	2692	22000	10462
1800	132,87	2,21	10,5	2719	22000	10856
1800	144,69	2,03	9,7	2740	22000	11208
1800	165,25	1,77	8,5	2770	22000	11776

IB123

M2 [Nm]	i	P1 [kW]	n2 [1/min]	Fr1 [N]	Fr2 (a) [N]	Fr2 (b) [N]
1500	7,97	30,67	175,8	2561	17308	4945
1800	9,62	30,48	145,5	2570	17484	4995
2000	10,33	31,52	135,5	2521	17181	4909
2000	12,48	26,10	112,2	2775	18875	5393
2100	13,84	24,71	101,1	2841	19393	5541
2100	15,38	22,24	91,0	2957	20420	5834
2200	18,58	19,29	75,4	3095	21892	6255
2500	20,61	19,76	67,9	3073	21629	6180
2800	22,78	20,02	61,5	3061	21364	6104
2800	25,89	17,62	54,1	3174	22840	6526
2800	27,51	16,58	50,9	3223	23562	6732
2800	30,79	14,81	45,5	3306	24944	7127
2800	31,26	14,59	44,8	3316	25133	7181
2800	34,68	13,15	40,4	3384	26458	7559
2800	40,53	11,25	34,5	3473	28532	8152
3000	44,89	10,89	31,2	3490	29033	8295
3200	49,80	10,47	28,1	3510	29606	8459
3200	54,30	9,60	25,8	3550	30000	8825
3200	59,36	8,78	23,6	3589	30000	9214
3300	62,59	8,59	22,4	3598	30000	9319
3300	69,43	7,74	20,2	3638	30000	9795
3500	74,42	7,66	18,8	3641	30000	9859
3500	80,04	7,12	17,5	3667	30000	10211
3500	89,87	6,34	15,6	3703	30000	10788
3500	99,70	5,72	14,0	3733	30000	11324
3500	106,65	5,35	13,1	3750	30000	11682
3500	119,60	4,77	11,7	3777	30000	12309
3500	129,96	4,39	10,8	3795	30000	12780
3500	144,43	3,95	9,7	3816	30000	13395
3500	160,23	3,56	8,7	3834	30000	14022
3500	180,40	3,16	7,8	3853	30000	14766

IB143

M2 [Nm]	i	P1 [kW]	n2 [1/min]	Fr1 [N]	Fr2 (a) [N]	Fr2 (b) [N]
3000	10,84	45,08	129,2	2299	17471	17471
3100	11,87	42,55	118,0	2395	17969	17969
3100	14,49	34,86	96,7	2685	19947	19947
3200	17,04	30,59	82,2	2847	21300	21300
3600	18,66	31,43	75,0	2815	20860	20860
4000	21,00	31,03	66,7	2830	20767	20767
4400	22,77	31,47	61,5	2813	20285	20285
4600	25,63	29,24	54,6	2898	21002	21002
4600	27,44	27,30	51,0	2971	21858	21858
4700	30,05	25,48	46,6	3040	22664	22664
4700	33,01	23,19	42,4	3126	23910	23910
4800	36,67	21,32	38,2	3197	24993	24993
4800	40,29	19,41	34,7	3269	26324	26324
4800	44,16	17,70	31,7	3334	27663	27663
5000	48,35	16,84	29,0	3366	28308	28308
5000	53,16	15,32	26,3	3424	29777	29777
5000	54,63	14,91	25,6	3439	30209	30209
5000	59,02	13,80	23,7	3481	31452	31452
5000	64,88	12,55	21,6	3528	33022	33022
5000	70,43	11,56	19,9	3566	34421	34421
5000	77,12	10,56	18,2	3603	36011	36011
5000	85,54	9,52	16,4	3643	37890	37890
5000	94,13	8,65	14,9	3675	39680	39680
5000	105,83	7,70	13,2	3712	41952	41952
5000	111,94	7,28	12,5	3728	43071	43071
5000	124,62	6,54	11,2	3755	45000	45000
5000	136,44	5,97	10,3	3777	45000	45000
5000	149,59	5,44	9,4	3797	45000	45000
5000	166,53	4,89	8,4	3818	45000	45000
5000	187,24	4,35	7,5	3838	45000	45000

IB153

M2 [Nm]	i	P1 [kW]	n2 [1/min]	Fr1 [N]	Fr2 (a) [N]	Fr2 (b) [N]
4500	10,49	69,86	133,4	4000	32657	32657
4500	12,64	57,98	110,7	4000	35147	35147
5000	14,01	58,13	99,9	4000	35854	35854
5000	15,40	52,89	90,9	5000	37223	37223
6000	18,56	52,67	75,4	5000	38583	38583
6500	20,56	51,49	68,1	6000	39484	39484
6700	23,86	45,74	58,7	8000	41654	41654
6800	25,19	43,98	55,6	8000	42437	42437
8000	28,23	46,16	49,6	8001	42687	42687
8000	30,35	42,94	46,1	8002	44001	44001
8000	33,63	38,74	41,6	8003	45923	45923
8000	35,02	37,21	40,0	8004	46696	46696
8000	38,81	33,58	36,1	8005	48711	48711
8000	42,30	30,81	33,1	8006	50452	50452
8000	47,53	27,41	29,5	8007	52894	52894
8000	50,56	25,77	27,7	8008	54224	54224
8000	54,64	23,85	25,6	8009	55934	55934
8000	57,27	22,75	24,4	8010	56993	56993
8000	60,92	21,39	23,0	8011	58408	58408
8000	63,47	20,53	22,1	8012	59362	59362
8000	71,10	18,30	19,7	8012	62092	62092
8000	77,22	16,87	18,1	8014	64114	64114

IB153

M2 [Nm]	i	P1 [kW]	n2 [1/min]	Fr1 [N]	Fr2 (a) [N]	Fr2 (b) [N]
8000	83,90	15,50	16,7	8017	65000	65000
8000	87,70	14,90	16,0	8018	65000	65000
8000	93,05	14,00	15,0	8017	65000	65000
8000	103,12	12,64	13,6	8018	65000	65000
8000	123,88	10,50	11,3	8017	65000	65000
8000	134,27	9,70	10,4	8018	65000	65000
8000	149,26	8,70	9,4	8017	65000	65000
8000	165,42	7,90	8,5	8018	65000	65000

IB163

M2 [Nm]	i	P1 [kW]	n2 [1/min]	Fr1 [N]	Fr2 (a) [N]	Fr2 (b) [N]
6800	8,89	124,58	157,4	8030	47199	47199
7900	10,58	121,69	132,4	8111	48279	48279
7700	11,87	105,68	117,9	8052	50654	50654
8800	12,81	111,92	109,3	8046	49930	49930
9600	14,08	111,04	99,4	8073	50243	50243
10000	15,52	104,95	90,2	8076	51412	51412
9900	16,39	98,42	85,4	7987	52573	52573
10400	18,02	94,04	77,7	8145	53920	53920
10700	19,96	87,34	70,2	8177	55666	55666
10400	21,94	77,21	63,8	9366	58947	58947
10500	24,17	70,76	57,9	9332	60819	60819
11100	26,58	68,03	52,7	9417	62202	62202
10200	28,80	57,69	48,6	9320	65000	65641
11500	30,92	60,58	45,3	9354	64939	64939
11900	34,25	56,59	40,9	9362	65000	66847
12300	37,66	53,20	37,2	9493	65000	69123
12700	40,65	50,89	34,4	8274	65000	70411
12000	45,09	43,35	31,0	9265	65000	74137
13000	51,00	41,52	27,5	8342	65000	76999
13000	53,63	39,49	26,1	9468	65000	78179
13000	58,97	35,92	23,7	9656	65000	80000
13000	69,78	30,35	20,1	9594	65000	80000
13000	76,72	27,60	18,2	9770	65000	80000
13000	87,54	24,19	16,0	9679	65000	80000
13000	96,25	22,00	14,5	9847	65000	80000
13000	103,93	20,38	13,5	9731	65000	80000
13000	114,27	18,53	12,3	9895	65000	80000
13000	126,29	16,77	11,1	9781	65000	80000
13000	138,85	15,25	10,1	9940	65000	80000
13000	154,83	13,68	9,0	9962	65000	80000

Fr2(a) = FD, FS, FP, SD, SS, SP, UC, UD, US, UP

Fr2(b) = FC, FL, FM, SC, SL, SM, UL, UM + B083UC Ø45

BA/CBA..2 - Dimensioni / Dimensions / Encombremets / Abmessungen / Dimensiones / 尺寸

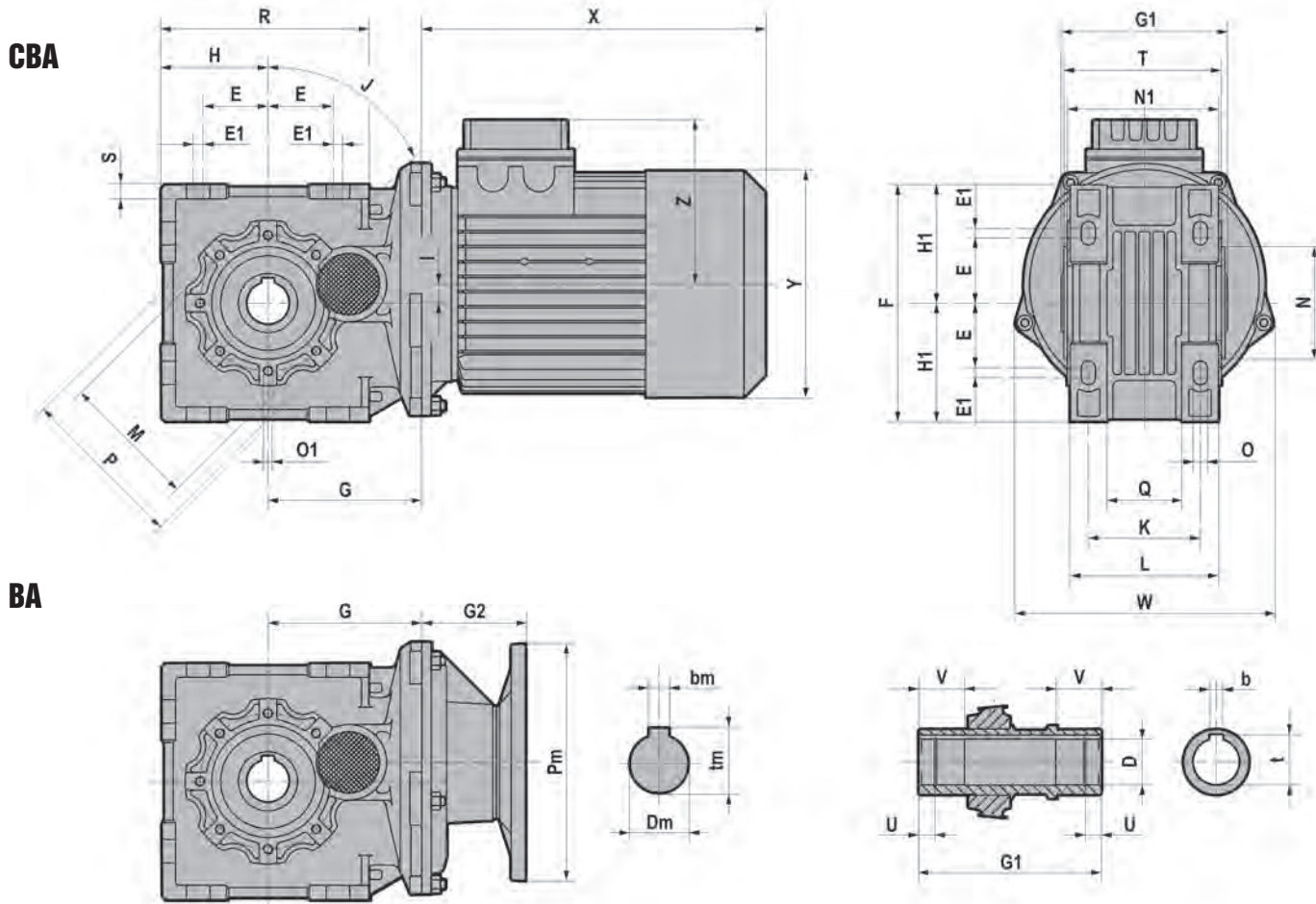

B..CB..	D	b	t	U	V	E	E1	F	G	G1	H	H1	I	J
A42	20 H7	6	22.8	/	30	45	/	130	95	100	65	65	8	45
A52	25 H7	8	28.3	/	30	55	/	160	98	112	80	80	4.2	45
	(28 H7)	(8)	(31.1)	/	(30)									
A72	35 H7	10	38.3	12	35	55	8	200	129.5	140	90	100	16	45
	(30 H7)	(8)	(33.3)	(12)	(35)									

B..CB..	K	L	M	N	N1	O	O1	P	Q	R	S	T	W
A42	73.5	90	85	70 h8	92	9	M8 n°4	100	45	127.5	8	97	152
A52	80	100	95	80 h8	102	9	M8 n°6	110	51	153	10	108	152
A72	94.5	125	115	95 h8	130	12	M8 n°7	136	63	175	12	136	218

	G2	
	A42-A52	A72
063	55	/
071	55	/
080	86	87.5
090	86	87.5
100-112	/	87.5

	~ Kg		
	A42	A52	A72
063	4,8	5,4	/
071	4,9	5,5	/
080-090	5,1	5,7	15,3
100-112	/	/	15,5

- Kg senza olio
- Kg w/o oil
- Kg sans huile
- Kg ohne Öl
- Kg sin aceite
- Kg 无油

- Per le dimensioni relative alla zona attacco motore (Pm, Dm, bm, tm, X, Y, Z) fare riferimento alla tabella di pag. 50, 58.
- For the dimensions concerning the motor connection area (Pm, Dm, bm, tm, X, Y, Z) please refer to the table shown at page 50, 58.
- Pour les dimensions concernant la zone de montage du moteur (Pm, Dm, bm, tm, X, Y, Z) lire SVP le tableau à la page 50, 58.
- Zu den Abmessungen des Motoranschlußflansches (Pm, Dm, bm, tm, X, Y, Z) siehe Tabelle auf Seite 50, 58.
- Para las dimensiones correspondientes a la zona del motor (Pm, Dm, bm, tm, X, Y, Z) consulte la tabla de la página 50, 58.
- 由于输出范围关系到电机的接线范围 (Pm, Dm, bm, tm, X, Y, Z), 请参考第 50, 58 页上的表格

- (..) Solo su richiesta
- (..) Only on request
- (..) Seulement sur demande
- (..) Auf Wunsch
- (..) Sólo bajo pedido
- (..) 仅仅根据需要提供

BA/CBA..3 - Dimensioni / Dimensions / Encombremets / Abmessungen / Dimensiones / 尺寸

CBA

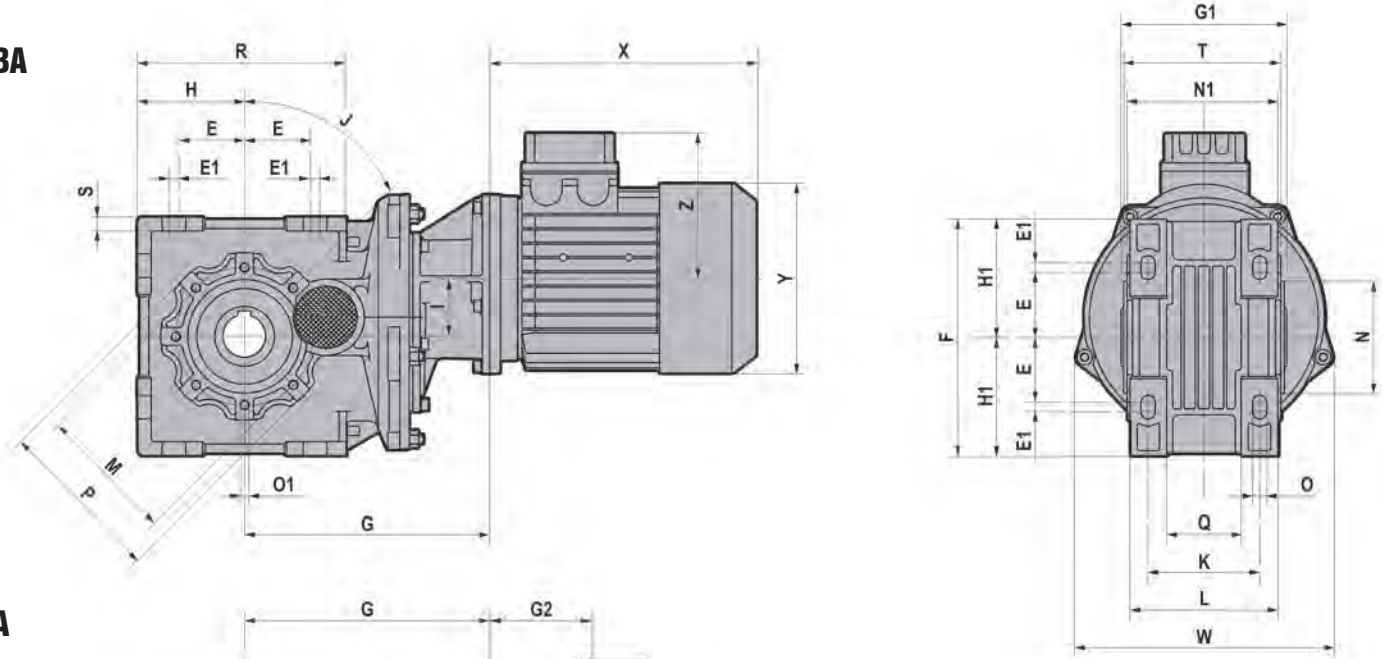

BA

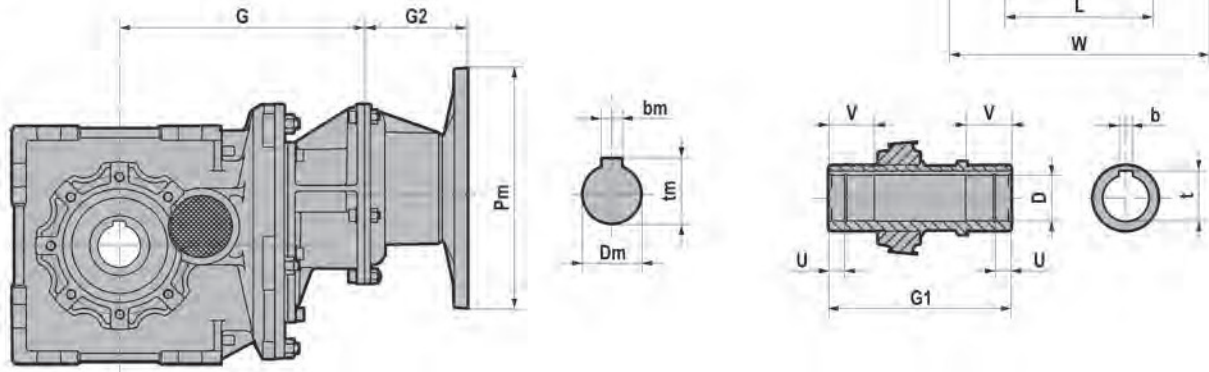

B..CB..	D	b	t	U	V	E	E1	F	G	G1	H	H1	I	J
A53	25 H7	8	28.3	/	30	55	/	160	162	112	80	80	36.2	45
	(28 H7)	(8)	(31.1)	/	30									
A73	35 H7	10	38.3	12	35	55	8	200	204.5	140	90	100	48	45
	(30 H7)	(8)	(33.3)	12	35									

B..CB..	K	L	M	N	N1	O	O1	P	Q	R	S	T	W
A53	80	100	95	80 h8	102	9	M8 no6	110	51	153	10	108	152
A73	94.5	125	115	95 h8	130	12	M8 no7	136	63	175	12	136	218

	G2
063	55
071	55
080	86
090	86

~ Kg		
	A53	A73
063	7	14.2
071	7.1	14.3
080-090	8.5	15.7

- Kg senza olio
- Kg w/o oil
- Kg sans huile
- Kg ohne Öl
- Kg sin aceite
- Kg 无油

- Per le dimensioni relative alla zona attacco motore (Pm, Dm, bm, tm, X, Y, Z) fare riferimento alla tabella di pag. 50, 58.
- For the dimensions concerning the motor connection area (Pm, Dm, bm, tm, X, Y, Z) please refer to the table shown at page 50, 58.
- Pour les dimensions concernant la zone de montage du moteur (Pm, Dm, bm, tm, X, Y, Z) lire SVP le tableau à la page 50, 58.
- Zu den Abmessungen des Motoranschlußflansches (Pm, Dm, bm, tm, X, Y, Z) siehe Tabelle auf Seite 50, 58.
- Para las dimensiones correspondientes a la zona del motor (Pm, Dm, bm, tm, X, Y, Z) consulte la tabla de la página 50, 58.
- 由于输出范围关系到电机的接线范围 (Pm, Dm, bm, tm, X, Y, Z), 请参考第 50, 58 页上的表格

- (..) Solo su richiesta
- (..) Only on request
- (..) Seulement sur demande
- (..) Auf Wunsch
- (..) Sólo bajo pedido
- (..) 仅仅根据需要提供

**CBA..2/3 - Dimensioni / Dimensions / Encombremets /
Abmessungen / Dimensiones / 尺寸**
CBA...

T - Motore / Motor / Moteur / Motor / Motor / 电机

CB		063	071	080	090S	090L	100	112
A42-A52 A53-A73	X	180	205	223	237	262	/	/
	Y	121	139	158	173	173	/	/
	Z	104	112	122	130	130	/	/
A72	X	/	/	218	232	257	290	302
	Y	/	/	158	173	173	191	211
	Z	/	/	122	130	130	139	154

TB - Motore autofrenante / Brake motor / Moteur frein / Bremsmotor / Motor-freno / 制动电机

CB		063	071	080	090S	090L	100	112
A42-A52 A53-A73	X	238	270.5	294	313	338	/	/
	Y	121	139	158	173	173	/	/
	Z	104	112	122	130	130	/	/
A72	X	/	/	290	309	334	372	400
	Y	/	/	158	173	173	191	211
	Z	/	/	122	130	130	139	154

Peso / Weight / Poids / Gewicht / Peso / 重量 - (kg)

T - Motore / Motor / Moteur / Motor / Motor / 电机

CB	063	071	080	090S	090L	100	112
A42	7,4	9.3	13.3	/	/	/	/
A52	8.2	10.2	14.2	16.1	18.6	/	/
A53	9.7	11.7	15.7	17.6	20.1	/	/
A72	/	/	21.6	23.6	26.1	34.6	41.6
A73	16.9	18.9	22.9	24.9	27.4	/	/

TB - Motore autofrenante / Brake motor / Moteur frein / Bremsmotor / Motor-freno / 制动电机

CB	063	071	080	090S	090L	100	112
A42	8,8	11.3	16.4	/	/	/	/
A52	9.6	12.1	17.3	20.9	13.5	/	/
A53	11.1	13.6	18.8	22.4	25	/	/
A72	/	/	25.6	27.1	31.6	41.6	51.6
A73	18.4	20.9	26.9	28.9	32.9	/	/

- Kg senza olio
- Kg w/o oil
- Kg sans huile
- Kg ohne Öl
- Kg sin aceite
- Kg 无油

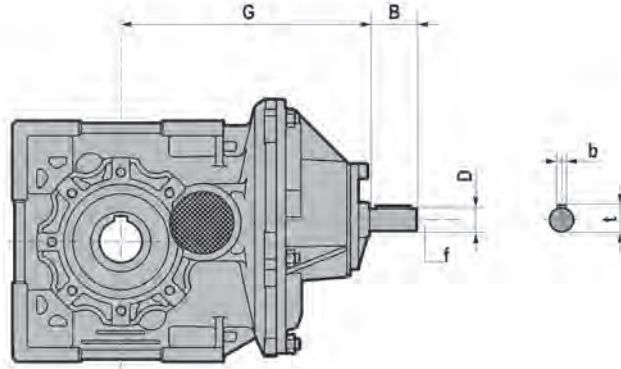
**IBA..2/3 - Dimensioni / Dimensions / Encombremets /
Abmessungen / Dimensiones / 尺寸**
A42 - A52 - A72

	G	Dj6	B	b	t	f	~kg
A42	175,5	16	40	5	18	M6	4,8
A52	179	16	40	5	18	M6	5,4
A72	210	19	40	6	21,5	M6	15,4

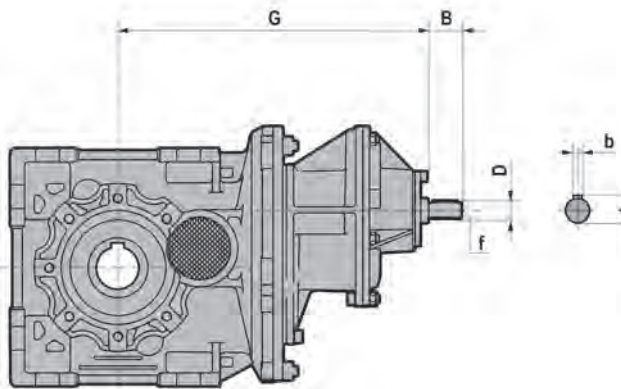
A53 - A73

	G	Dj6	B	b	t	f	~kg
A53	242,5	16	40	5	18	M6	8,2
A73	285	16	40	5	18	M6	15,4

- Kg senza olio
- Kg w/o oil
- Kg sans huile
- Kg ohne Öl
- Kg sin aceite
- Kg 无油

- Per le dimensioni non contemplate fare riferimento al dimensionale CBA/BA della grandezza relativa.
- For the missing dimensions, please consider the drawing of relevant CBA/BA size.
- Die nicht angegebenen Maße sind der Maßzeichnung des CBA/BA der entsprechenden Größe zu entnehmen.
- Pour les dimensions non spécifiées, nous vous prions de vous référer au dessin CBA/BA dans la taille désirée.
- Las cotas no indicadas corresponden a las dimensiones CBA/BA del tamaño correspondiente.
- 有关未列尺寸详情，请参阅相关 CBA/BA 规格的图纸。

**BA/CBA..2/3F - Dimensioni / Dimensions / Encombremets /
Abmessungen / Dimensiones / 尺寸**

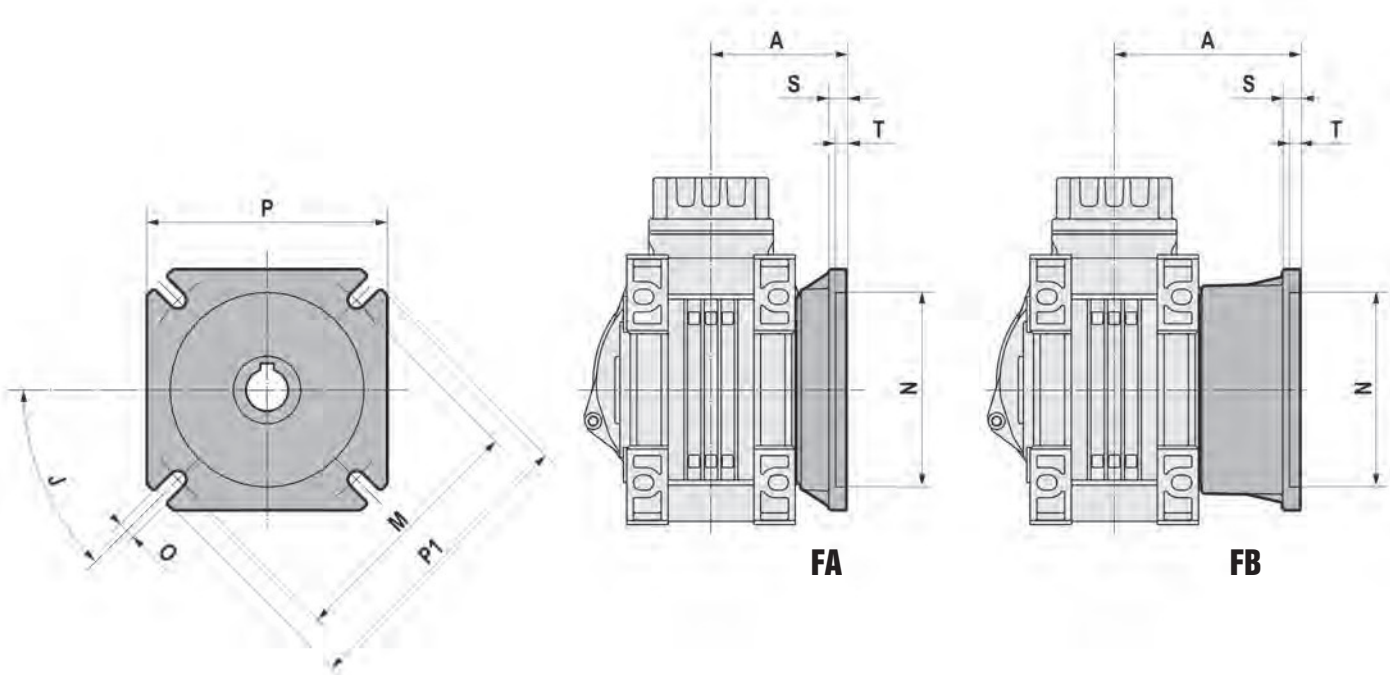

B..F - CB..F		A	J	M	N	O	P	P1	S	T
A40	FA	92.5	45	90 min	70 H8	11	110	125	9	5
	FB	122.5								
A50	FA	80	45	150	115 H8	11	142	180	10	6
	FB	110								
A70	FA	119	45	165	130 H8	14	170	200	13	6

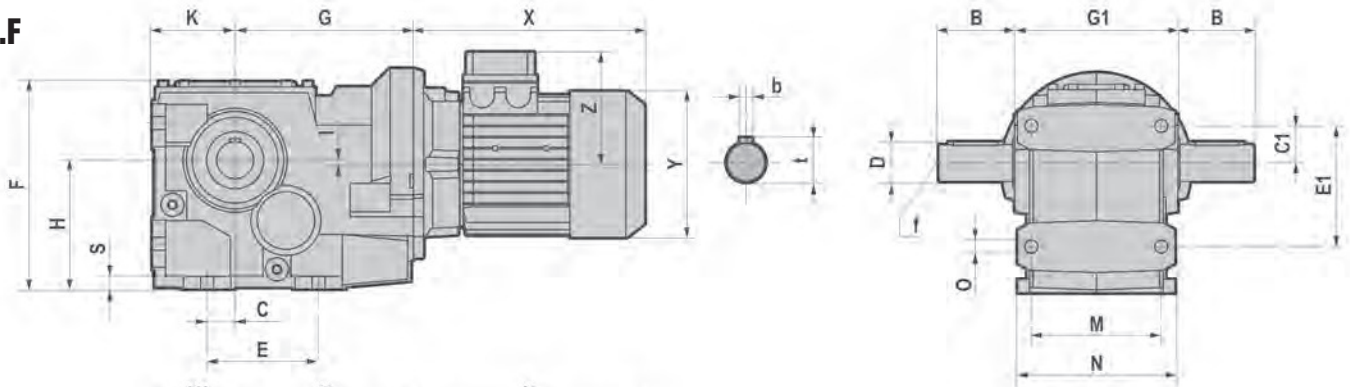
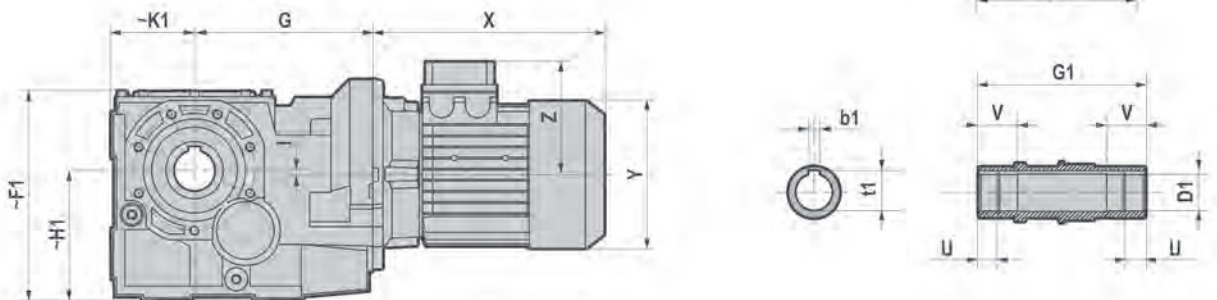
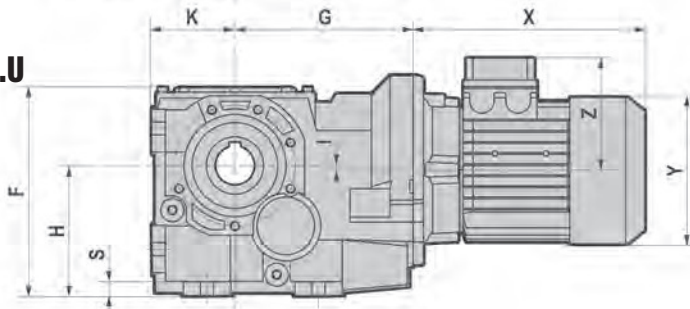
**B/CB... - Dimensioni / Dimensions / Encombremets /
Abmessungen / Dimensiones / 尺寸**
CB..F

CB..S

CB..U

- * Sede linguetta ribassata
- * Low profile key-way
- * Rainure de clavette surbaissée
- * Abgeflachte Passfeder
- * Chavetero rebajado
- * 小型键槽

B..CB..	D1	b1	t1	U	V	B	D	b	t	f	C	C1	E	E1
063	35 H7	10	38.3	12	35	58	35 k6	10	38	M12	30	39	130	126
	(40 H7)	(12)	(43.3)											
083	40 H7	12	43.3	22.25	42	80	40 k6	12	43	M16	30	40	120	130
	(45 H7)	(14)	(47.6 *)											
103	50 H7	14	53.8	25	50	100	50 k6	14	53.5	M16	40	50	150	160
123	60 H7	18	64.4	28	70	120	60 m6	18	64	M20	55	78	180	220
143	70 H7	20	74.9	27.5	75	140	70 m6	20	74.5	M20	75	90	240	280
153	90 H7	25	95.4	34	90	170	90 m6	25	95	M20	95	110	280	330
163	100 H7	28	106.4	40	100	210	110 m6	28	116	M20	115	155	350	420

B..CB..	F	~F1	G	G1	H	~H1	I	K	~K1	M	N	O	S
063	215	219.5	174	140	132	137	33	88	92.5	104	126	14	12
083	225	225	192	180	140	140	5	90	90	140	170	14	15
103	283	283	213.5	210	180	180	25	112	112	165	205	18	18
123	341	342	246	240	212	213	33.5	132	133	180	230	22	22
143	414	/	279	300	265	/	34	160	/	240	290	22	22
153	490	/	353	350	315	/	35	200	/	270	330	26	26
163	615	/	426.5	445	375	/	47	230.5	/	330	400	38	45

- Per le dimensioni relative alla zona attacco motore (X, Y, Z) fare riferimento alla tabella di pag. 55.
- For the dimensions concerning the motor connection area (X, Y, Z) please refer to the table shown at page 55.
- Pour les dimensions concernant la zone de montage du moteur (X, Y, Z) lire SVP le tableau à la page 55.
- Zu den Abmessungen des Motoranschlussflansches (X, Y, Z) siehe Tabelle auf Seite 55.
- Para las dimensiones correspondientes a la zona del motor (X, Y, Z) consulte la tabla de la página 55.
- 由于输出范围关系到电机的接线范围 (X, Y, Z), 请参考第 55 页上的表格

- (..) Solo su richiesta
- (..) Only on request
- (..) Seulement sur demande
- (..) Auf Wunsch
- (..) Sólo bajo pedido
- (..) 仅仅根据需要提供

B/CB...S/U - Dimensioni / Dimensions / Encombremets / Abmessungen / Dimensiones / 尺寸

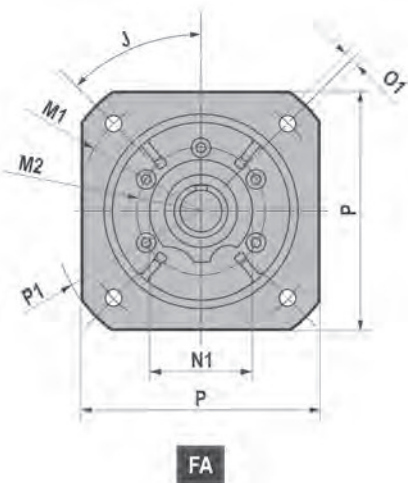
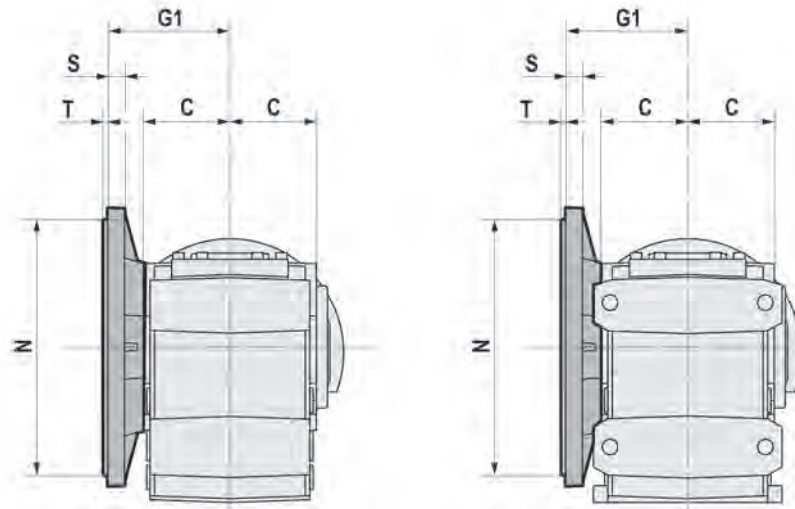

FA

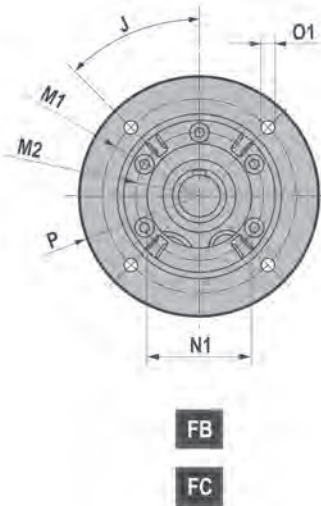

FB

FC

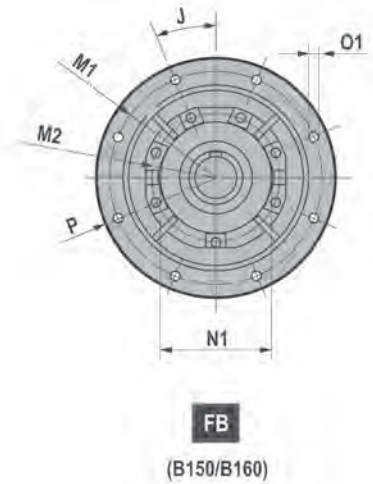

FB

(B150/B160)

B..S - B..U		J	M1	M2	N	N1	O	P	P1	S	T	C	G1
063	FA	45	265	130	230 f8	110	14	250	300	15	4	78	110
	FB	45	215	130	180 f8	110	14	250	/	15	4		
	FC	45	165	130	130 f8	110	11	200	/	15	3,5		
083	FA	45	265	130	230 f8	110	14	250	300	15	4	78	110
	FB	45	215	130	180 f8	110	14	250	/	15	4		
	FC	45	165	130	130 f8	110	11	200	/	15	3,5		
103	FA	45	300	165	250 f8	130	18	300	350	16	5	95	135
	FB	45	265	165	230 f8	130	14	300	/	16	4		
	FC	45	215	165	180 f8	130	14	250	/	16	4		
123	FB	45	300	185	250 f8	150	18	350	/	18	5	107,5	150
	FC	45	265	185	230 f8	150	14	300	/	18	4		
143	FB	45	350	200	300 f8	170	18	400	/	18	5	138	187,5
153	FB	22,5	400	245	350 f8	210	18	450	/	25	5	162,5	207,5
	FC	45	350	245	300 f8	210	18	400	/	25	5		
163	FB	22,5	500	298	450	255	18	550	/	28	5	202,5	256

**CB.. - Dimensioni / Dimensions / Encombremments /
Abmessungen / Dimensiones / 尺寸**
CB...

T - Motore / Motor / Moteur / Motor / Motor / 电机

CB		063	071	080	090S	090L	100	112	132S	132M
063	X	215	241	268	296	321	333	351	/	/
	Y	121	139	158	173	173	191	211	/	/
	Z	104	112	122	130	130	139	154	/	/
083 - 103	X	/	221	248	276	301	335	356	405	443
	Y	/	139	158	173	173	191	211	249	249
	Z	/	112	122	130	130	139	154	194	194
123 - 143	X	/	/	/	267	292	326	347	396	434
	Y	/	/	/	173	173	191	211	249	249
	Z	/	/	/	130	130	139	154	194	194

TB - Motore autofrenante / Brake motor / Moteur frein / Bremsmotor / Motor-freno / 制动电机

CB		063	071	080	090S	090L	100	112	132S	132M
063	X	273	306.5	341	373	398	415	448	/	/
	Y	121	139	158	173	173	191	211	/	/
	Z	104	112	122	130	130	139	154	/	/
083 - 103	X	/	286.5	321	353	378	417	453	505	547
	Y	/	139	158	173	173	191	211	249	249
	Z	/	112	122	130	130	139	154	194	194
123 - 143	X	/	/	/	343	368	407	443	495	537
	Y	/	/	/	173	173	191	211	249	249
	Z	/	/	/	130	130	139	154	194	194

Peso / Weight / Poids / Gewicht / Peso / 重量 - (kg)

T - Motore / Motor / Moteur / Motor / Motor / 电机

CB	063	071	080	090S	090L	100	112	132S	132M
063	24.1	25	29.7	33.6	35.6	41.1	52.6	/	/
083	/	/	35.7	38.1	39.6	44.7	56.1	70.1	81.7
103	/	/	61.4	63.8	65.3	70.4	81.8	95.8	107.4
123	/	/	/	85.7	86.7	92.7	102.7	117.7	126.7
143	/	/	/	/	/	138	148	163	172

TB - Motore autofrenante / Brake motor / Moteur frein / Bremsmotor / Motor-freno / 制动电机

CB	063	071	080	090S	090L	100	112	132S	132M
063	25.6	27.2	33.2	39.1	41.1	46.6	62.3	/	/
083	/	/	39.2	43.6	45.1	50.2	65.8	80.3	96.3
103	/	/	64.8	69.3	70.8	75.8	91.5	106.1	122.1
123	/	/	/	91.2	92.2	98.2	112.4	128	141.4
143	/	/	/	/	/	143.5	158	173	187

- Kg senza olio
- Kg w/o oil
- Kg sans huile
- Kg ohne Öl
- Kg sin aceite
- Kg 无油

B/PB... - Dimensioni / Dimensions / Encombremments / Abmessungen / Dimensiones / 尺寸

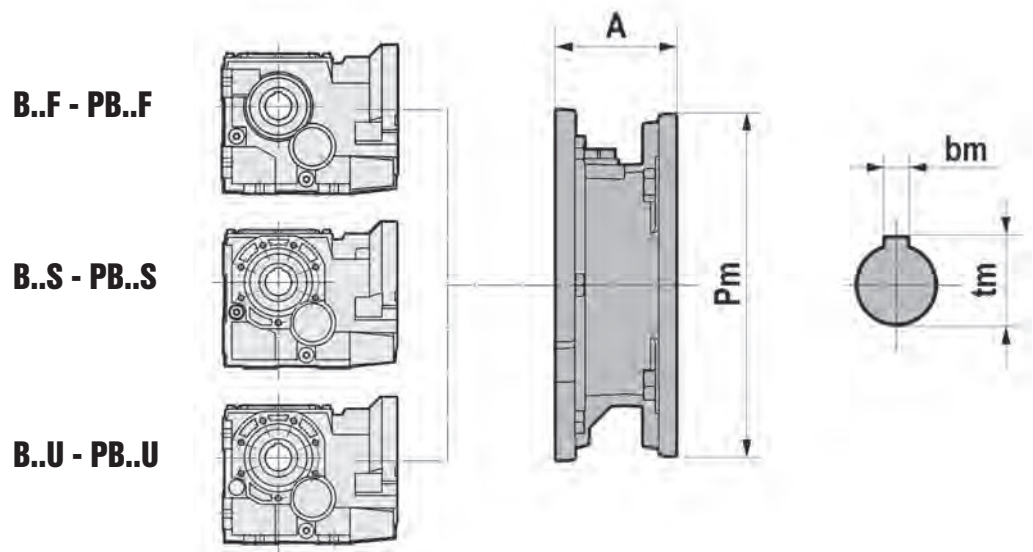

B PB	A				
	063	083 - 103	123 - 143	153	163
063	57	/	/	/	/
071	69	/	/	/	/
080-090	90	70	60,5	/	/
100-112	105	85	75,5	/	/
132	/	110	100,5	76	/
160	/	157,5	148	123,5	109
180	/	157,5	148	123,5	109
200	/	/	185	160,5	146
225	/	/	/	160,5	146
250	/	/	/	/	175
280	/	/	/	/	175

- Per le dimensioni relative alla zona attacco motore (Pm, Dm, bm, tm) fare riferimento alla tabella di pag. 58.
- For the dimensions concerning the motor connection area (Pm, Dm, bm, tm) please refer to the table shown at page 58.
- Pour les dimensions concernant la zone de montage du moteur (Pm, Dm, bm, tm) lire SVP le tableau à la page 58.
- Zu den Abmessungen des Motoranschlußflansches (Pm, Dm, bm, tm) siehe Tabelle auf Seite 58.
- Para las magnitudes correspondientes a la zona del motor (Pm, Dm, bm, tm) consulte la tabla de la página 58.
- 有关电机连接区域的尺寸 (Pm, Dm, bm, tm), 请参阅第 58 页上所示的表格。
- Kg senza olio
- Kg w/o oil
- Kg sans huile
- Kg ohne Öl
- Kg sin aceite
- Kg 无油

Peso / Weight / Poids / Gewicht / Peso / 重量 - (kg)

B PB	063	083	103	123	143	153	163
063	20,6	/	/	/	/	/	/
071	21	/	/	/	/	/	/
080-090	21,6	29,3	54,8	76,6	/	/	/
100-112	25,9	31,3	56,8	79	124	/	/
132	/	33,8	59,5	81,7	127	199	/
160-180	/	/	66,2	87,7	133	206,5	385,3
200	/	/	/	/	148	221	449,8
225	/	/	/	/	/	223	457,1
250	/	/	/	/	/	/	473,5
280	/	/	/	/	/	/	473,5

(kg) senza motore e olio / w/o motor and oil / sans moteur et huile / ohne Motor und Öl / sin motor y aceite / 无机油

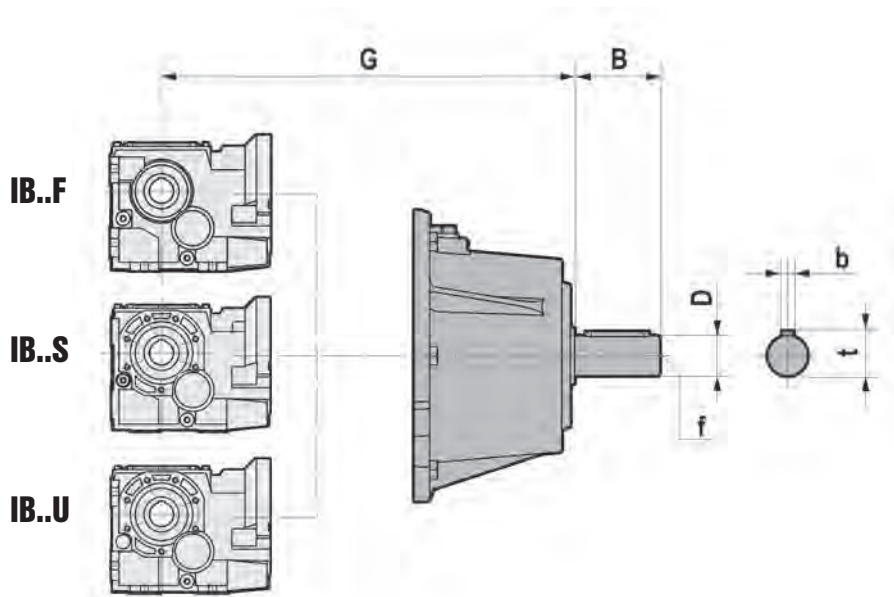
**IB... - Dimensioni / Dimensions / Encombrements /
Abmessungen / Dimensiones / 尺寸**

IB	G	B	D	b	t	f
063	264	50	24 j6	8	27	M8
083	305	60	28 j6	8	31	M10
103	326.5	60	28 j6	8	31	M10
123	372.5	80	38 k6	10	41	M12
143	405.5	80	38 k6	10	41	M12
153	493	110	42 k6	12	45	M16
163	561.5	110	48 k6	14	51.5	M16

Peso / Weight / Poids / Gewicht / Peso / 重量 - (kg)

IB	~ Kg
063	23,7
083	33,1
103	58,8
123	86,5
143	132
153	213
163	455,6

- Kg senza olio
- Kg w/o oil
- Kg sans huile
- Kg ohne Öl
- Kg sin aceite
- Kg 无油

PAM - Dimensioni / Dimensions / Encombremets /
Abmessungen / Dimensiones / 尺寸

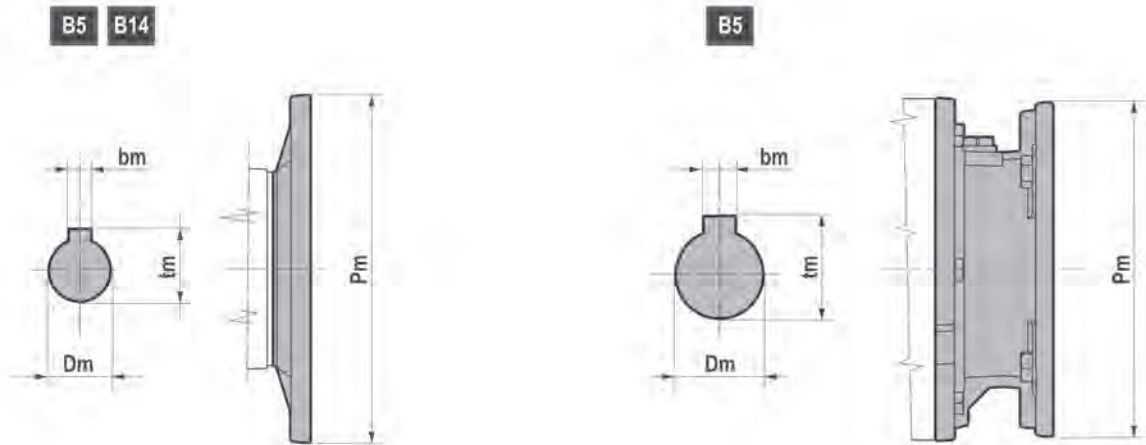

B5	PAM												
	063	071	080	090	100	112	132	160	180	200	225	250	280
Pm	140	160	200	200	250	250	300	350	350	400	450	550	550
Dm	11	14	19	24	28	28	38	42	48	55	60	65	75
bm	4	5	6	8	8	8	10	12	14	16	18	18	20
tm	12,8	16,3	21,8	27,3	31,3	31,3	41,3	45,3	51,8	59,3	64,4	69,4	79,9

B14	PAM						
	056	063	071	080	090	100	112
Pm	80	90	105	120	140	160	160
Dm	9	11	14	19	24	28	28
bm	3	4	5	6	8	8	8
tm	10,4	12,8	16,3	21,8	27,3	31,3	31,3

Posizione morsettiera / Position of terminal box / Position du bornier /
Klemmenkastenlage / Posición caja de bornes / 接线盒位置

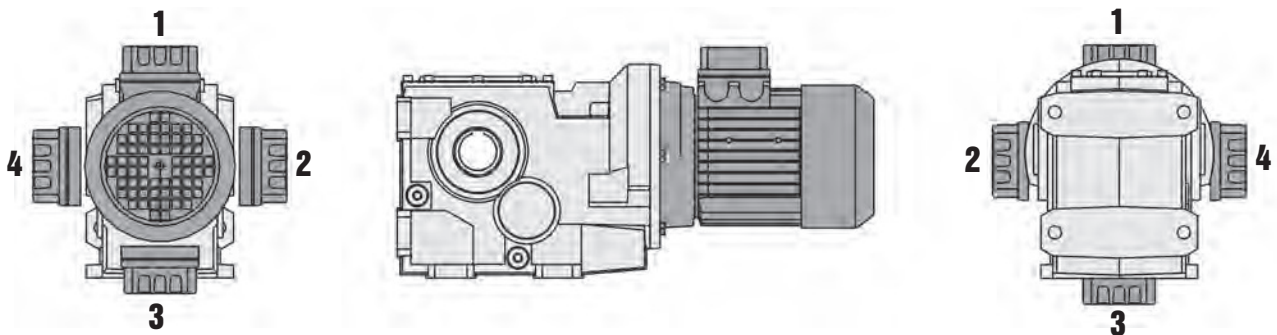

- Se non diversamente specificato in fase d'ordine, il gruppo viene fornito con morsettiera in pos.1.
- Unless otherwise specified when ordering, the gear reducer is supplied with terminal box in position 1.
- Sauf indications contraires lors de la commande, le réducteur est fourni avec boîte à borne en position 1.
- Sofern in der Bestellung nicht anders spezifiziert, wird der Schneckengetriebemotor mit Klemmkastenlage 1 geliefert.
- De no especificarse lo contrario en el pedido, el motorreductor se monta con caja de bornes en posición 1.
- 除非订货时另有说明，齿轮减速机将在位置 (1) 处配备接线盒

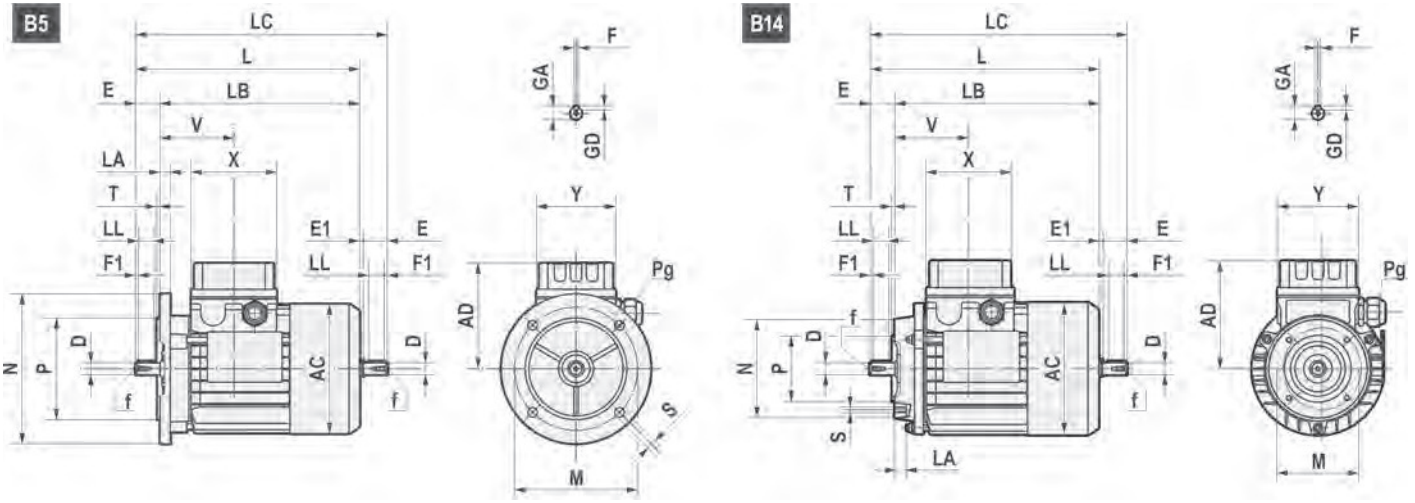
Motori elettrici / Electric motors / Moteurs électriques / Elektromotoren / Motores eléctricos / 电机

	AC	AD	L	LB	LC	X	Y	V	D	E	E1	f	F1	GA	F	GD	LL	Pg		
																		ø min	ø max	
63	121	103,5	211	188	235,5	80	74	69	11 j6	23	1,5	M4x10	2,5	12,5	4	4	15	M16x1,5	5	10
71	139	112	238,5	208,5	271	80	74	74,5	14 j6	30	2,5	M5x12,5	3	16	5	5	20	M20x1,5	6	12
80	158	121,5	272,5	232,5	314	80	74	78	19 j6	40	1,5	M6x16	5	21,5	6	6	30	M20x1,5	6	12
90S	173	129,5	298	248	349,5	98	98	89,5	24 j6	50	1,5	M8x19	5	27	8	7	35	M25x1,5	9	17
90L	173	129,5	323	273	374,5	98	98	89,5	24 j6	50	1,5	M8x19	5	27	8	7	35	M25x1,5	9	17
100	191	138,5	368	308	431,5	98	98	97,5	28 j6	60	2,5	M10x22	7,5	31	8	7	45	M25x1,5	9	17
112	210,5	153,5	382,5	322,5	447	98	98	100	28 j6	60	1,5	M10x22	7,5	31	8	7	45	M25x1,5	9	17
132S	248,4	194	452	382	536,5	118	118	115,5	38 k6	80	4	M12x28	10	41	10	8	60	M32x1,5	11	21
132M/L	248,4	194	490	410	574,5	118	118	115,5	38 k6	80	4	M12x28	10	41	10	8	60	M32x1,5	11	21

B5	M	N	P	LA	S	T
63	115	95 j6	140	9,5	9	3
71	130	110 j6	160	10	9,5	3,5
80	165	130 j6	200	12	11	3,5
90	165	130 j6	200	12	11	3,5
100	215	180 j6	250	15	14	4
112	215	180 j6	250	14,5	14	4
132	265	230 j6	300	20	14	3,5

B14	M	N	P	LA	S	T
63	75	60 j6	90	10,5	M5	2,5
71	85	70 j6	105	10,5	M6	2,5
80	100	80 j6	120	10,5	M6	3
90	115	95 j6	140	11,5	M8	3
100	130	110 j6	160	15	M8	3,5
112	130	110 j6	160	11,5	M8	3,5
132	165	130 j6	200	20,5	M10	3,5

Potenza nominale (kW) / Nominal power (kW) / Puissance nominale (kW) / Nennleistung (kW) / Potencia nominal (kW) / 标称功率 (kW)

	63A	63B	63C	71A	71B	71C	80A	80B	80C	90S
2(*)	0,18	0,25	0,37	0,37	0,55	0,75	0,75	1,1	1,5	1,5
4(*)	0,12	0,18	0,22	0,25	0,37	0,55	0,55	0,75	0,92	1,1
6(*)	0,09	0,12	0,15	0,18	0,25	0,37	0,37	0,55	0,75	0,75
8(*)			0,07	0,09	0,12	0,18	0,18	0,25	0,37	0,37
	90L	90LL	100LA	100LB	112M	112MS	132SA	132SB	132L	132M
2(*)	2,2		3	4	4	5,5	5,5	7,5	9,2	11
4(*)	1,5	1,84	2,2	3	4	4,8	5,5		7,5	9,2
6(*)	1,1		1,5	1,85	2,2	3	3		4	5,5
8(*)	0,55		0,75	1,1	1,5		2,2		3	

(*) Poli / Poles / Pôles / Pole / Polos / 极性

**Flangia / Flange / Flaque /
Flansch / Brida / 法兰**

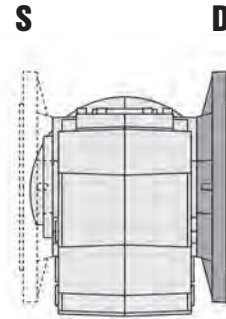
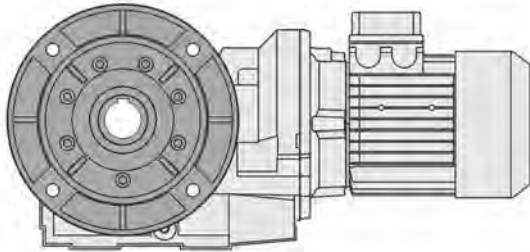

- Se non diversamente specificato il riduttore viene fornito con flangia in pos. D riferito alla posizione di piazzamento B3/B5.
- Unless specified otherwise, the reduction unit is supplied with the flange in pos. D referred to position B3/B5.
- Si non différemment spécifié, le réducteur est livré avec bride en pos. D correspondant à la position de montage B3/B5.
- Falls nicht anders vereinbart, wird das Getriebe mit Flansch in Position D, auf die B3/B5-Einbaulage bezogen, geliefert.
- Si no se especifica lo contrario el reductor se entrega con brida en pos. D, referida a la posición de montaje B3/B5.
- 除非另有其它规定，减速机都配供是指 B3/B5位置的D 位法兰。

Braccio di reazione / Torque arm / Bras de r action / Drehmomentst tze / Brazo de reacci n / 扭矩臂

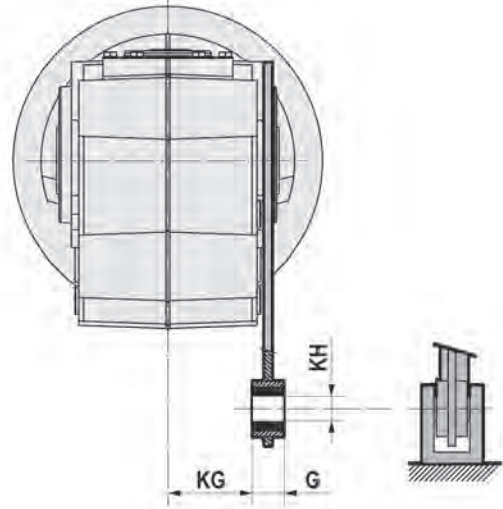
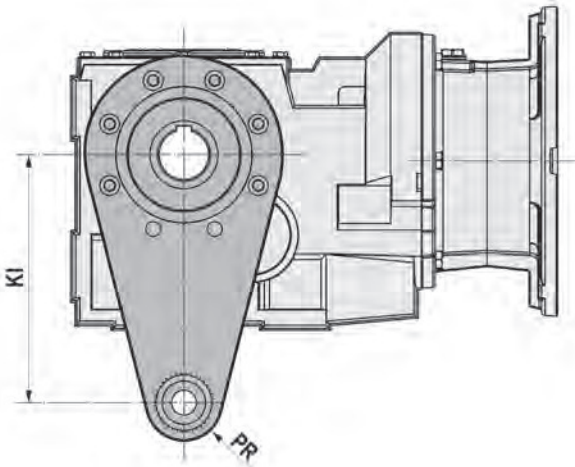

	KI	KG	KH	G	R
A40	100	41	10	14	18
A50	150	47	10	14	18
A70	200	55,5	20	25	30
063S	200	62	20	25	30
083S	200	68,5	20	25	30
103S	250	83	25	30	35
123S	300	91,5	25	40	40
063U	200	62	20	25	30
083U	200	78,5	20	25	30
103U	250	95	25	30	35
123U	300	103,5	25	40	40

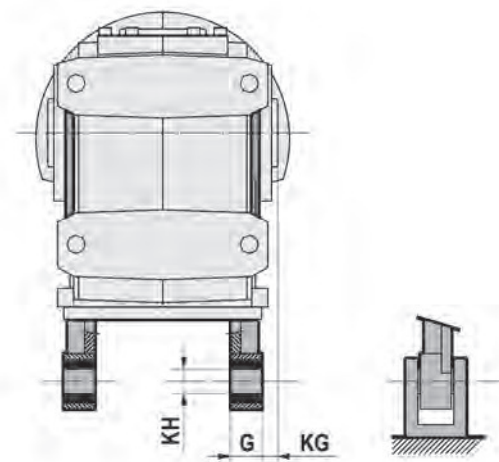
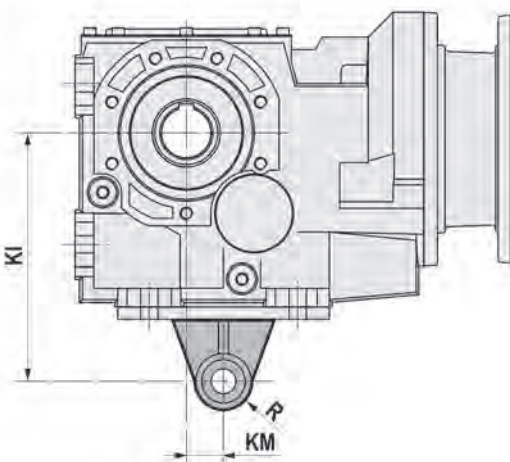

	KM	KI	KG	KH	G	R
143	45	350	40	30	60	45
153	45	450	45	30	60	45
163	60	550	7,5	40	110	65

**Calettatore / Shrink disc / Frette d'accouplement /
Schrumpfscheibe / Aro de apriete / 锁紧盘**

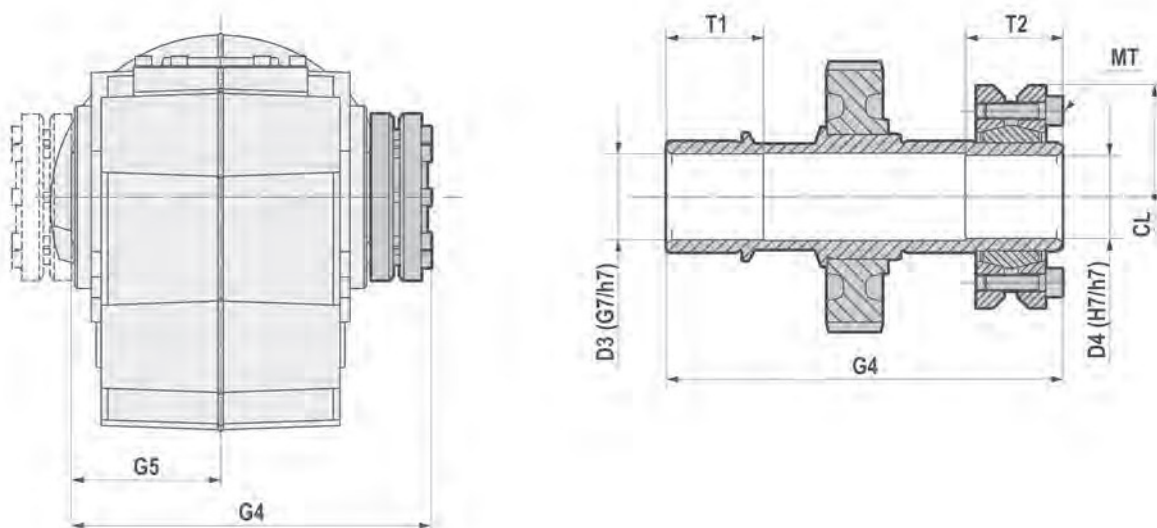

	D3	D4	G4	G5	T1	T2	CL	MT 12.9 (Nm)
A40	24	24	130	50	25	35	72	15
A50	31	30	143	56	35	35	80	15
A70	36	35	173	70	40	35	80	15
063	36	35	173	70	40	35	80	15
080	41	40	217	90	50	40	100	15
100	51	50	248	105	55	40	115	15
125	61	60	282	120	60	50	145	40
140	72	70	355	150	70	65	170	50
150	92	90	415	175	80	75	184	70
163	102	100	512	222,5	100	100	215	70

- Pulire e sgrassare le zone degli alberi interessati all'accoppiamento. Rispettare la coppia di serraggio viti indicata (MT).
- Clean and degrease the surfaces of the shaft to be fitted to. Comply with the indicated tightening torque of screws (MT).
- Nettoyer et dégraisser les surfaces des arbres intéressés par l'accouplement. Respecter le couple de serrage des vis indiqué (MT).
- Vor Montage der Schrumpfscheibe den Außendurchmesser der Hohlwelle reinigen und entfetten. Die Schrauben (MT) mit dem vorgeschriebenen Drehmoment anziehen.
- Pulir y desengrasar las superficies de fijación. Respetar el par de apriete indicado para los tornillos (MT).
- 清洁待安装的轴并去除其表面油脂。螺杆拉紧转矩 (MT) 应与指定值一致。

**Dispositivo antiretro / Backstop device / Système antidéviEUR /
RücklaufsperrE / Dispositivo antirretorno / 止退装置**
Dispositivo antiretro
IT

Il riduttore può essere fornito munito di dispositivo antiretro sull'asse veloce. L'antiretro permette la rotazione degli alberi in un solo senso, a seconda della grandezza è disponibile nella flangia PAM oppure nel motore, senza ingombri aggiuntivi. E' molto importante, in fase di ordine, specificare il senso di rotazione richiesto.

Backstop device
UK

The gear reducer can be supplied with backstop device on input shaft. Backstop device allows output shaft rotation in only one sense of direction; according to the size, it is available in the input flange or in the motor with the same dimensions. It is important to specify the required sense of direction on the order.

Système antidéviEUR
FR

Le réducteur de vitesse peut être fourni avec le dispositif anti-retour sur l'axe d'entrée. Le dispositif anti retour permet la rotation des arbres de sortie dans un seul sens; selon la taille, il est disponible dans la bride d'entrée ou dans le moteur avec les mêmes dimensions. Il est important de spécifier le sens de la direction demandé sur l'ordre.

RücklaufsperrE
DE

Das Getriebe ist mit RücklaufsperrE auf der Antriebswelle erhältlich. Die RücklaufsperrE verhindert die Rotation in die falsche Drehrichtung. Entsprechend der Größe ist sie im Antriebsflansch oder dem Motor integriert. Wichtig ist die Angabe der gewünschten Abtriebsdrehrichtung

Dispositivo antirretorno
ES

El reductor puede suministrarse con un dispositivo antirretorno en el eje veloz. El antirretorno permite la rotación de los ejes en un solo sentido, según el tamaño está disponible en la brida PAM o en el motor, sin incremento de dimensiones. Es muy importante especificar en el pedido el sentido de rotación requerido.

止退装置
CN

我方可提供输入轴上装有逆止器的减速机，该逆止器使输出轴仅能以一种方向旋转。逆止器可安装于输入法兰或电机内，尺寸相同。订货时，请务必说明所需的旋转方向。

Alberi lenti / Low speed shafts / Arbres pv /
Abtriebswellen / Ejes lentos / 低速轴

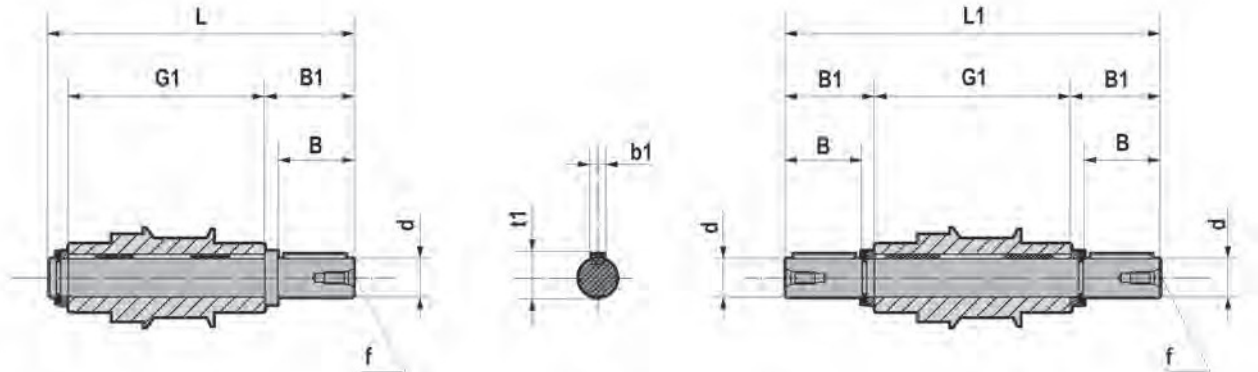

	d h6	B	B1	G1	L	L1	f	b1	t1
A40	20	40	43,5	100	151	187	M6	6	22,5
A50	25	50	53,5	112	173	219	M10	8	58
060	35	58	62	140	210,5	264	M12	10	38
080	40	80	84,25	180	273	348,5	M16	12	43
100	50	100	105	210	325	420	M16	14	53,5
125	60	120	125	240	375	490	M20	18	64
140	70	140	146	300	458	592	M20	20	74,5
150	90	170	176,5	350	540	703	M20	25	95
160	110	210	217,5	445	677	880	M20	28	116

BA70

